



US00D630941S

(12) **United States Design Patent**
Paredes et al.

(10) **Patent No.:** **US D630,941 S**
(45) **Date of Patent:** **** Jan. 18, 2011**

(54) **FILTER PACKAGE**

2,120,900 A 6/1938 Moore

(75) Inventors: **Apollo Paul Paredes**, Cincinnati, OH (US); **Ivan Anderson Huber**, Cincinnati, OH (US)

(Continued)

(73) Assignee: **The Procter & Gamble Company**, Cincinnati, OH (US)

OTHER PUBLICATIONS

Internet Cite: <http://www.target.com/Archer-Farms-Blueberry-Granola-Cereal/dp/B0015R2BNG>, Jul. 31, 2009.

(**) Term: **14 Years**

(Continued)

(21) Appl. No.: **29/342,808**

Primary Examiner—Robert M Spear

Assistant Examiner—Karen Acker

(22) Filed: **Sep. 1, 2009**

(74) *Attorney, Agent, or Firm*—Cynthia L. Clay; Kim William Zerby

Related U.S. Application Data

(62) Division of application No. 29/326,371, filed on Oct. 16, 2008.

(51) **LOC (9) Cl.** **09-03**

(52) **U.S. Cl.** **D9/430**

(58) **Field of Classification Search** D9/430–433, D9/414, 418, 420–424; D3/272; 206/267, 206/269, 270, 273, 299, 737, 740, 822; 229/100, 229/101, 101.3, 106, 108–112, 114–117, 229/117.05–117.09, 117.24–117.26, 221, 229/222, 227, 902, 939, 941, 942

See application file for complete search history.

(56) **References Cited**

U.S. PATENT DOCUMENTS

960,922 A	6/1910	Hirschwitz et al.	
1,116,752 A *	11/1914	Stolk	220/8
1,119,467 A *	12/1914	Steiner	220/8
1,158,699 A	11/1915	McCleery	
1,210,127 A	12/1916	Wood	
1,246,932 A	11/1917	Jones	
1,344,716 A *	6/1920	Powell	220/8
1,358,875 A	11/1920	Reynolds	
1,450,674 A *	4/1923	Marston	220/8
1,563,056 A	11/1925	Williams et al.	
1,707,841 A *	4/1929	Broadfoot	220/8
1,809,355 A *	6/1931	Powell	220/8
2,120,898 A	6/1938	Moore	

(57) **CLAIM**

The ornamental design for a filter package, as shown, and described.

DESCRIPTION

FIG. 1 is a perspective view of an embodiment of a filter package illustrating our new design;

FIG. 2 is a front side elevational view thereof and a back side elevational view thereof;

FIG. 3 is a left side elevational view thereof and a right side elevational view thereof;

FIG. 4 is a top planar view thereof;

FIG. 5 is a bottom planar view thereof;

FIG. 6 is a perspective view of the filter package of FIG. 1, wherein a top portion and a bottom portion of the filter package are illustrated in a separated orientation;

FIG. 7 is a front side elevational view thereof and a backside elevational view thereof;

FIG. 8 is a left side elevational view thereof and a right side elevational view thereof;

FIG. 9 is a top planar view thereof; and,

FIG. 10 is a bottom planar view thereof.

1 Claim, 8 Drawing Sheets

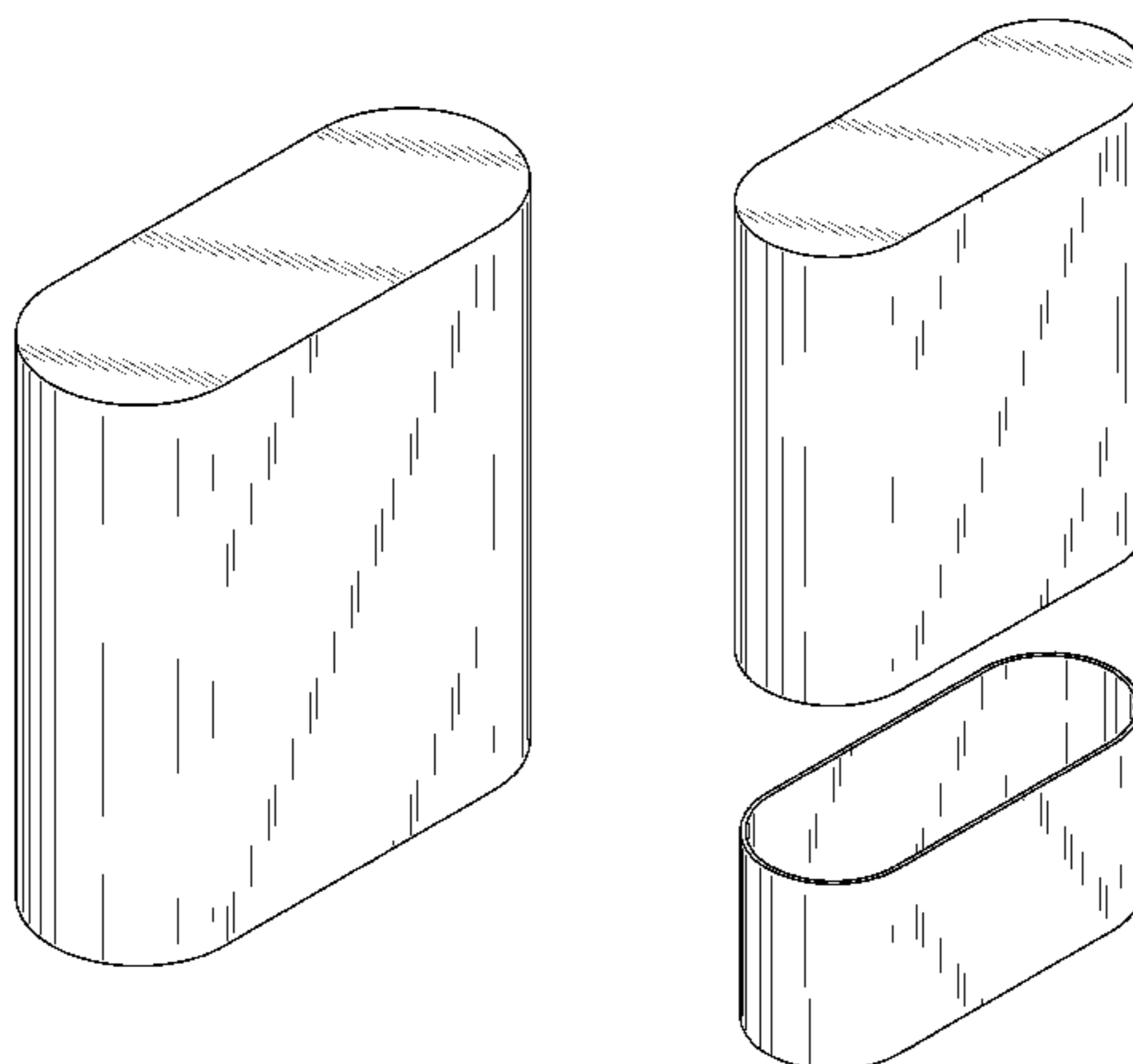

US D630,941 S

Page 2

U.S. PATENT DOCUMENTS

2,157,255	A *	5/1939	Bumpass	229/5.5	D405,007	S	2/1999	Naas, Sr.	
D141,980	S	8/1945	Holland et al.		D407,439	S *	3/1999	Kossnar et al.	D19/85
2,387,392	A	10/1945	Hennessey et al.		6,003,759	A *	12/1999	Kenner et al.	229/104
D151,730	S	11/1948	Baud		D438,378	S	3/2001	Charness	
D158,396	S	5/1950	Libson		D444,381	S	7/2001	Barr	
2,594,012	A *	4/1952	Griffin	220/323	D451,019	S	11/2001	Lueders	
3,844,407	A *	10/1974	Buie	206/1.5	D464,877	S	10/2002	Weinstein et al.	
3,877,573	A *	4/1975	Scott et al.	206/236	D474,109	S	5/2003	Owens	
4,396,113	A *	8/1983	Gail et al.	206/1.5	7,000,775	B2 *	2/2006	Gelardi et al.	206/776
4,441,610	A *	4/1984	Cavalcante	206/361	D525,865	S	8/2006	Cavero et al.	
D285,128	S	8/1986	Yuen		D546,175	S *	7/2007	Sainz	D9/420
D286,506	S	11/1986	Poore et al.		7,318,523	B2	1/2008	Spatafora	
D301,771	S	6/1989	Bakic		D596,024	S	7/2009	McCoy et al.	
4,884,912	A *	12/1989	Gueret	401/78	7,644,823	B2 *	1/2010	Gelardi et al.	206/776
D306,220	S	2/1990	Wang		2003/0132274	A1	7/2003	Kalberer et al.	
4,930,682	A	6/1990	Gordon et al.		2004/0055909	A1	3/2004	Gamberi et al.	
4,934,534	A	6/1990	Wagner		2005/0199692	A1 *	9/2005	Nelson et al.	229/182.1
D345,304	S	3/1994	Leader		2008/0099353	A1 *	5/2008	Parsons et al.	206/266
D351,969	S	11/1994	Daenen et al.						
5,383,552	A	1/1995	Dikowitz						
D355,359	S	2/1995	Herzog						
D356,252	S *	3/1995	Thompson	D9/729					
D357,858	S	5/1995	Dikowitz						
D363,218	S	10/1995	Mann						

OTHER PUBLICATIONS

Internet Cite: <http://www.kleenex.com/NA/Products/Kleenex-Tissues.aspx>, Jul. 31, 2009.

Internet Cite: <http://popsop.com/search/sivaris>, Jun. 2, 2008.

* cited by examiner

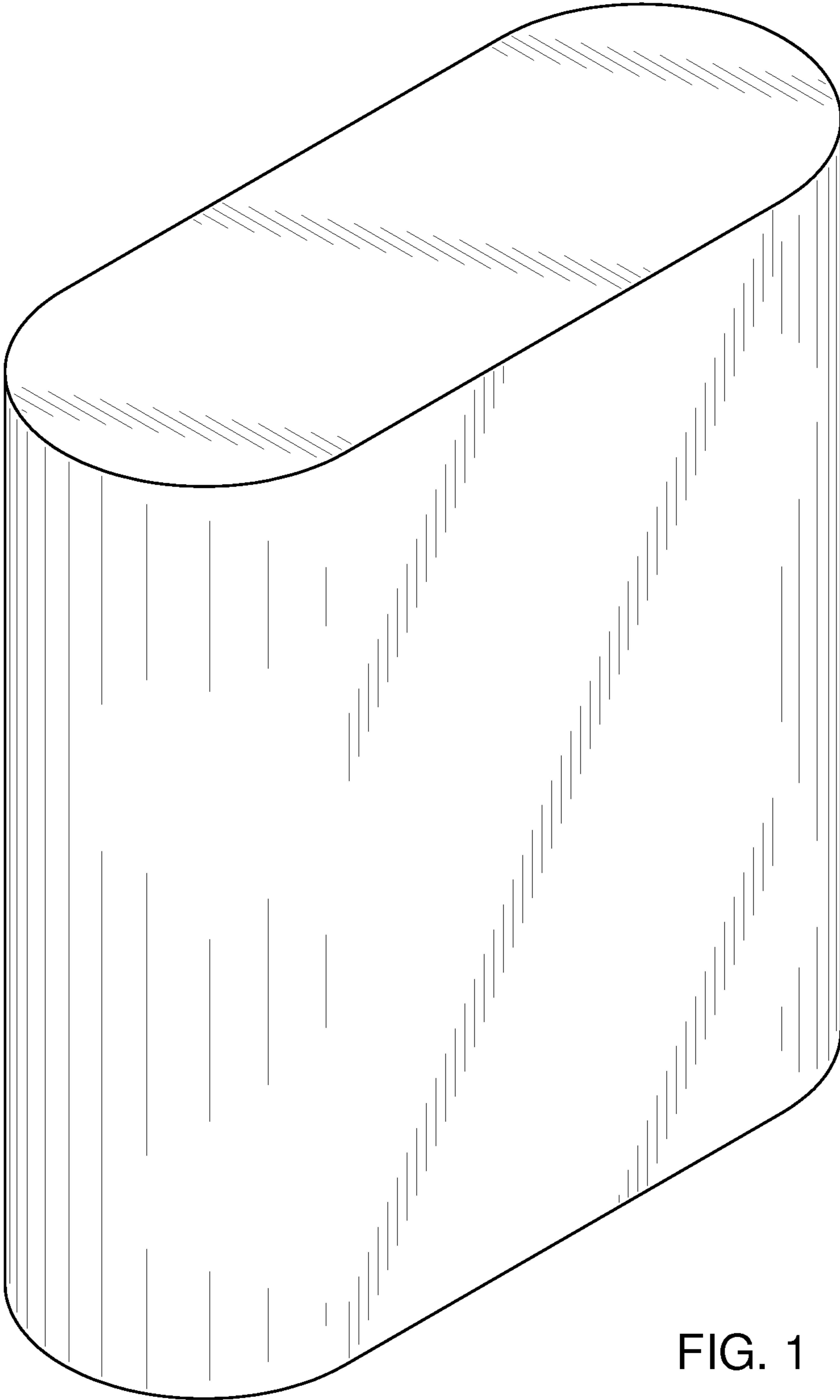

FIG. 1

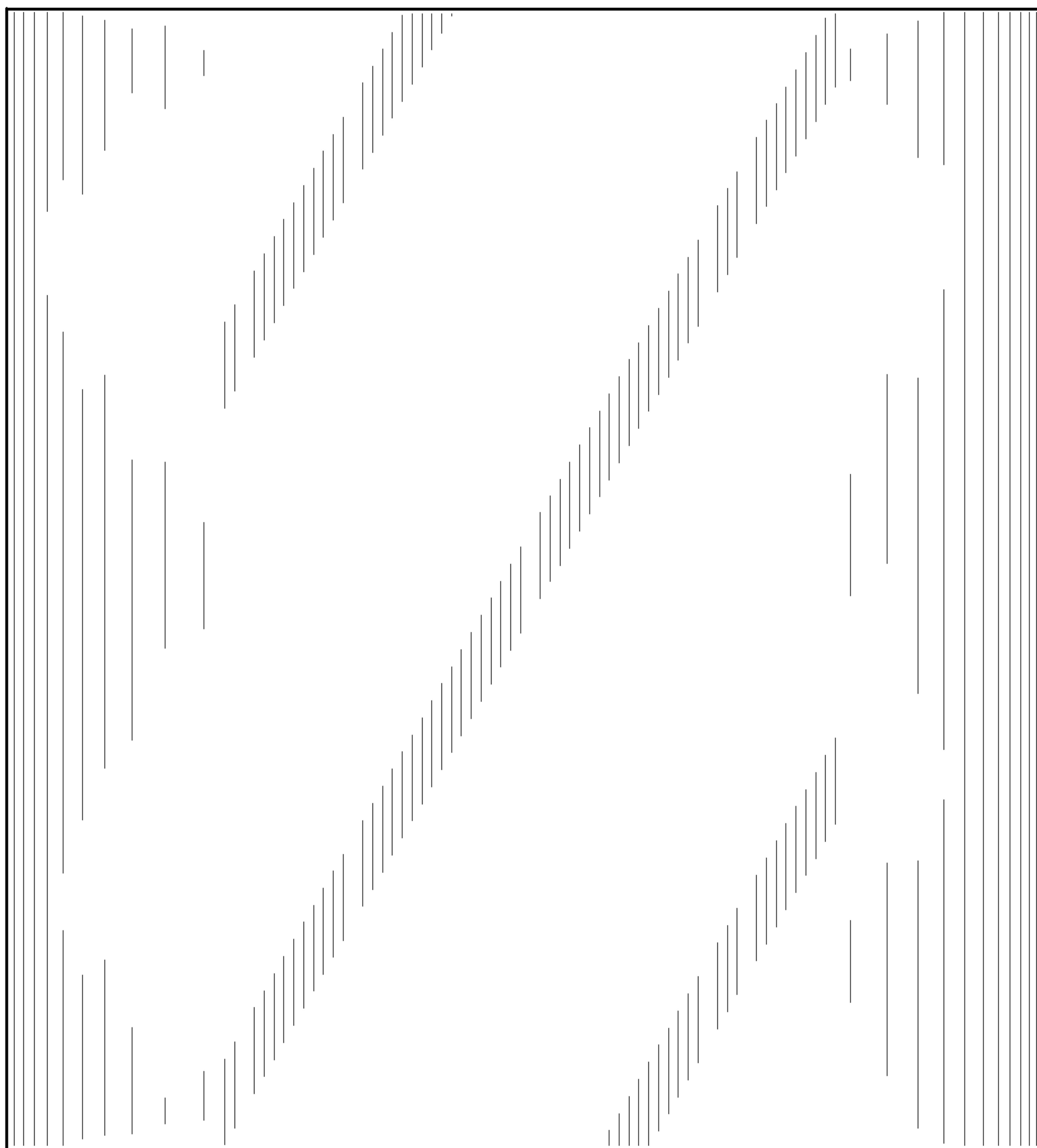

FIG. 2

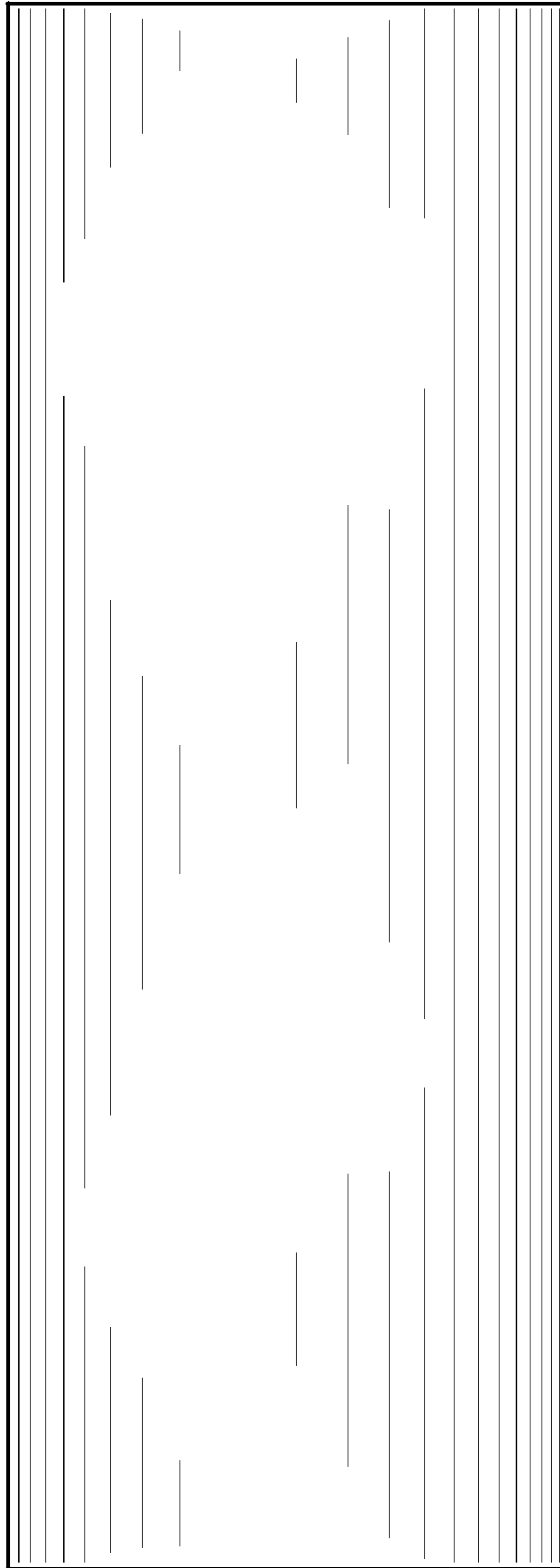

FIG. 3

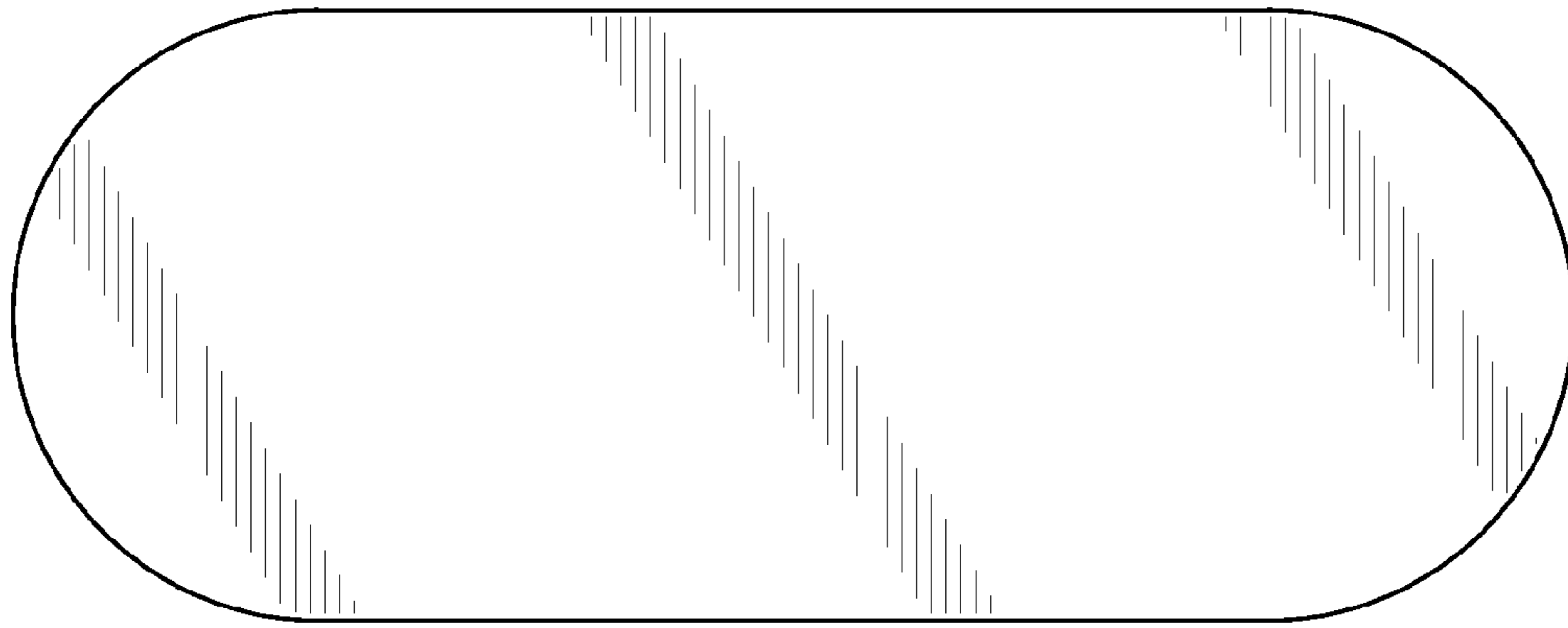

FIG. 4

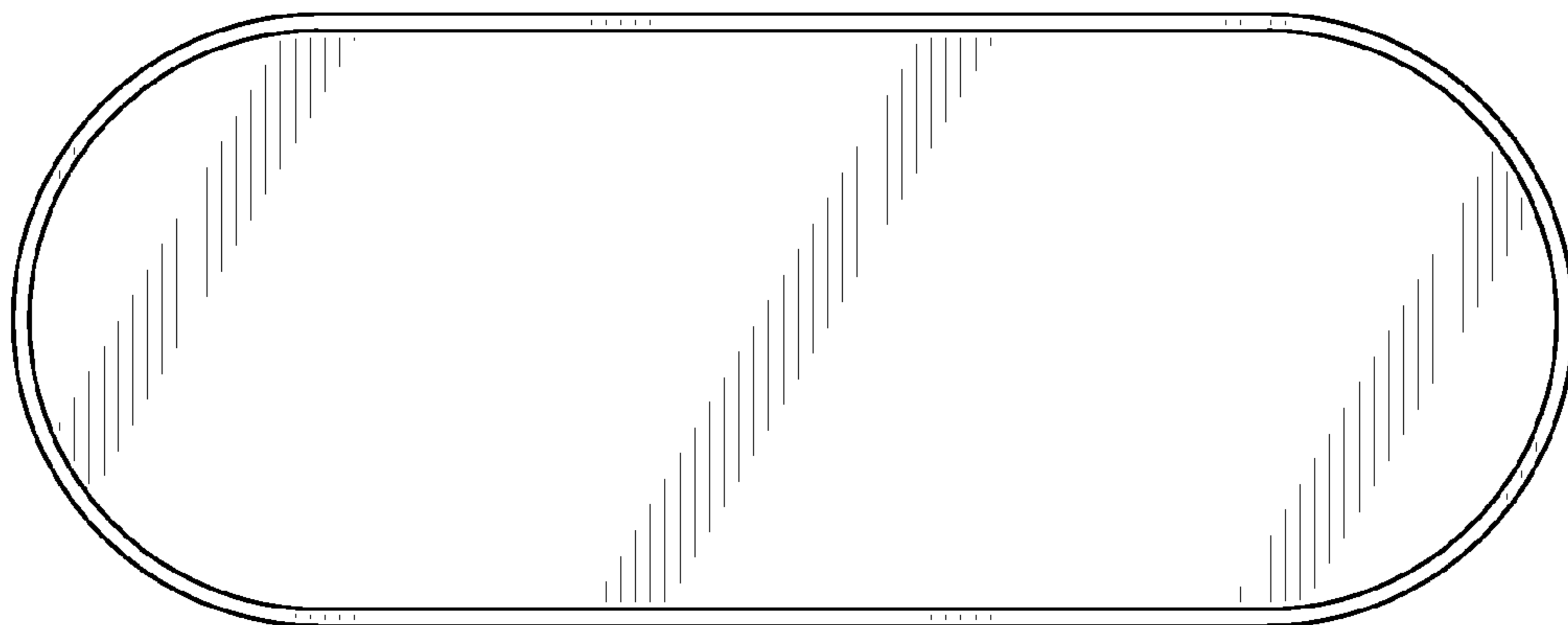

FIG. 5

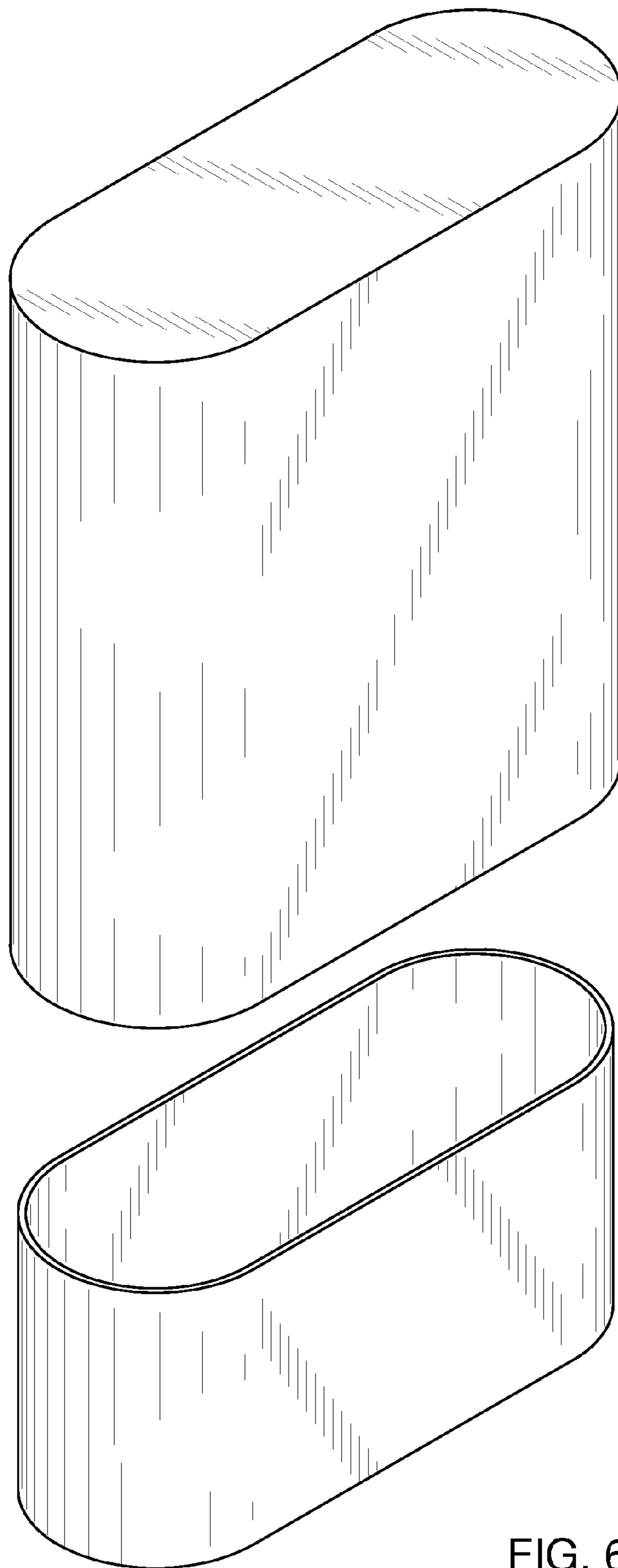

FIG. 6

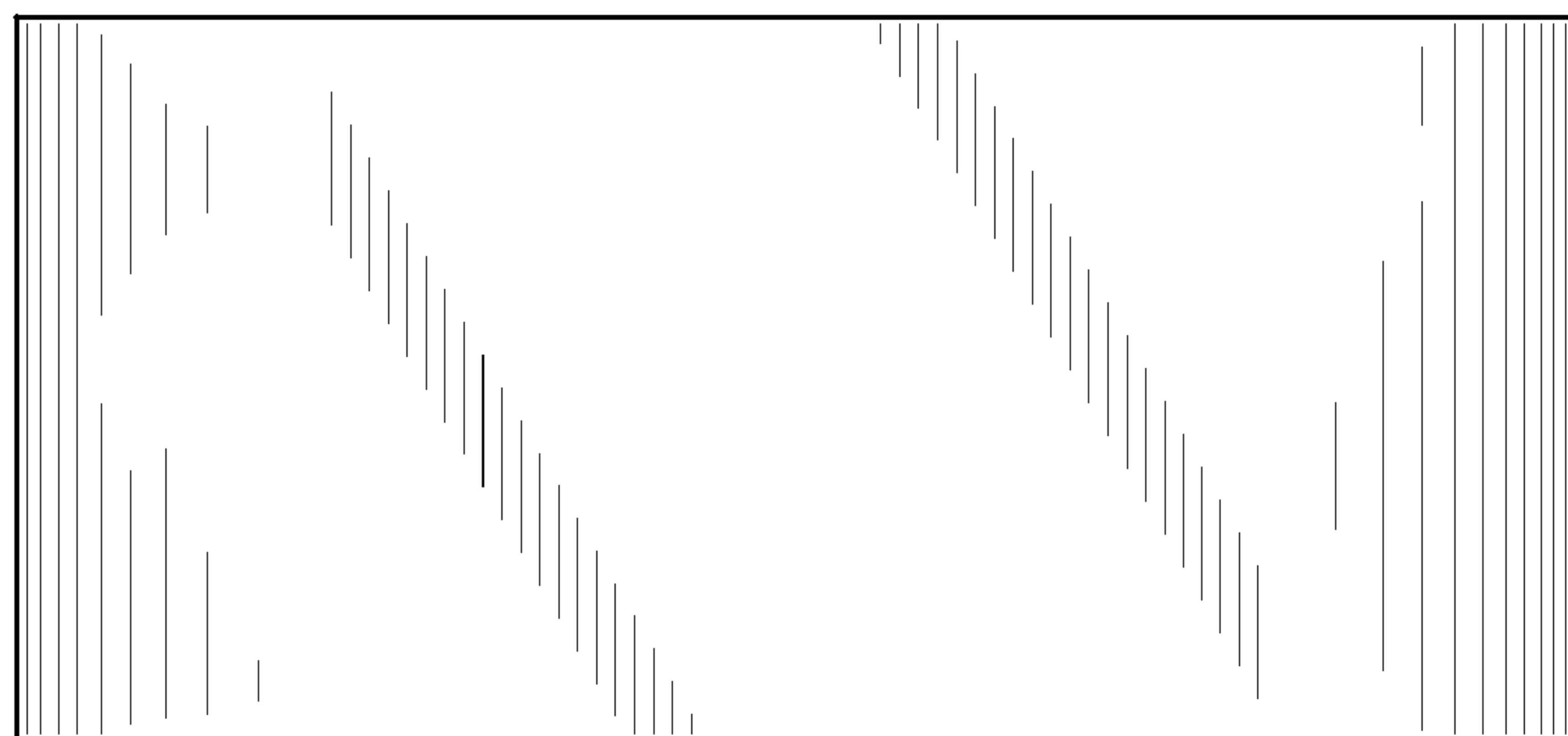
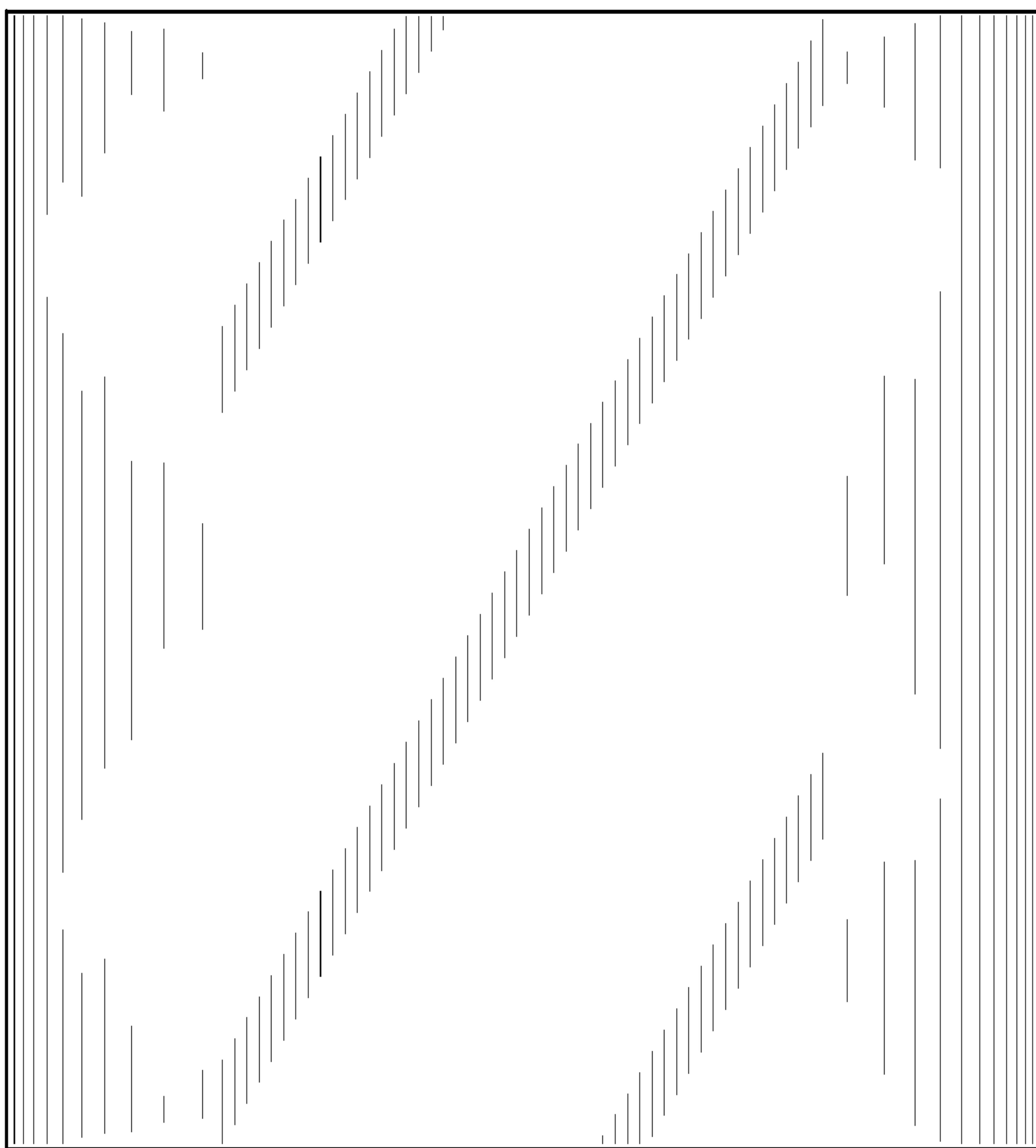

FIG. 7

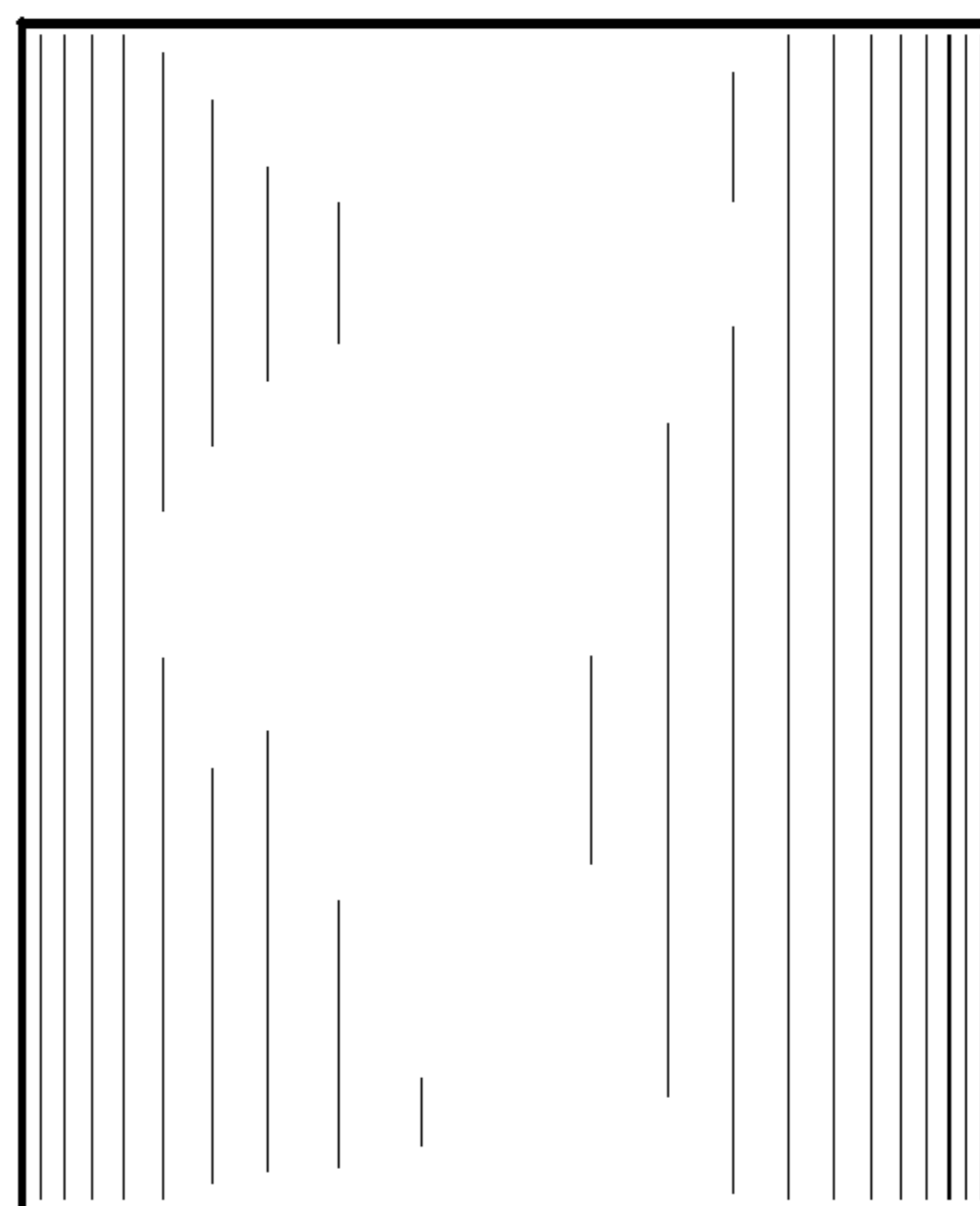
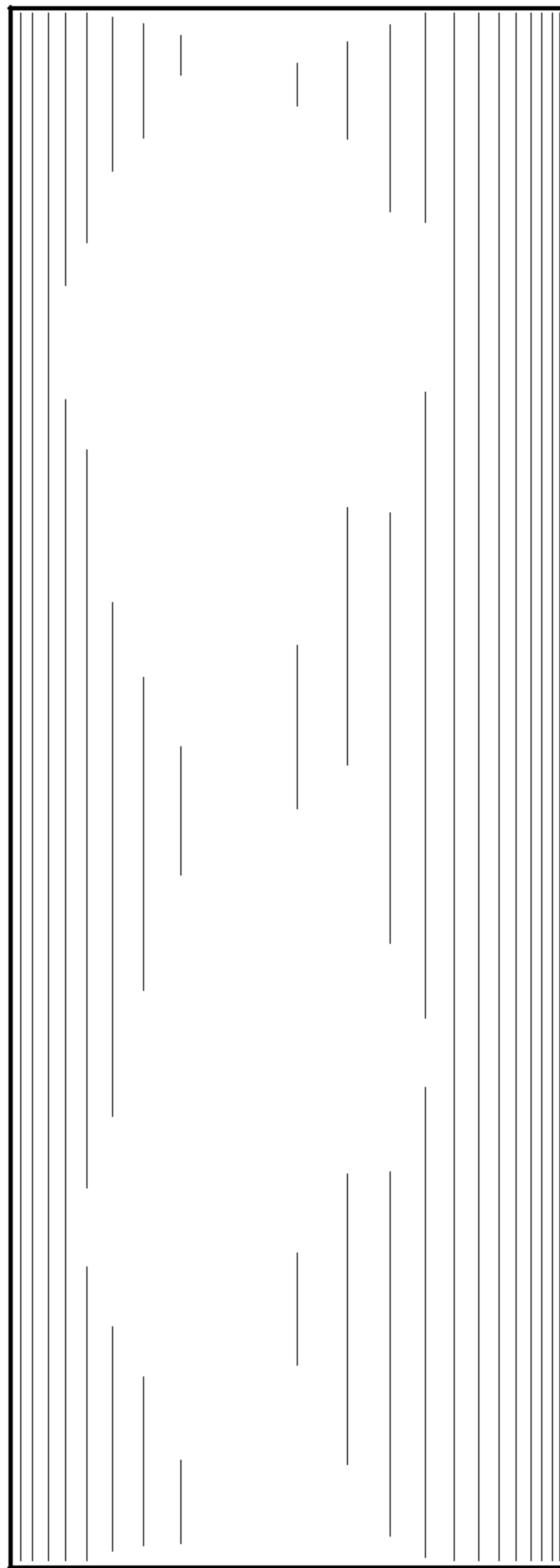

FIG. 8

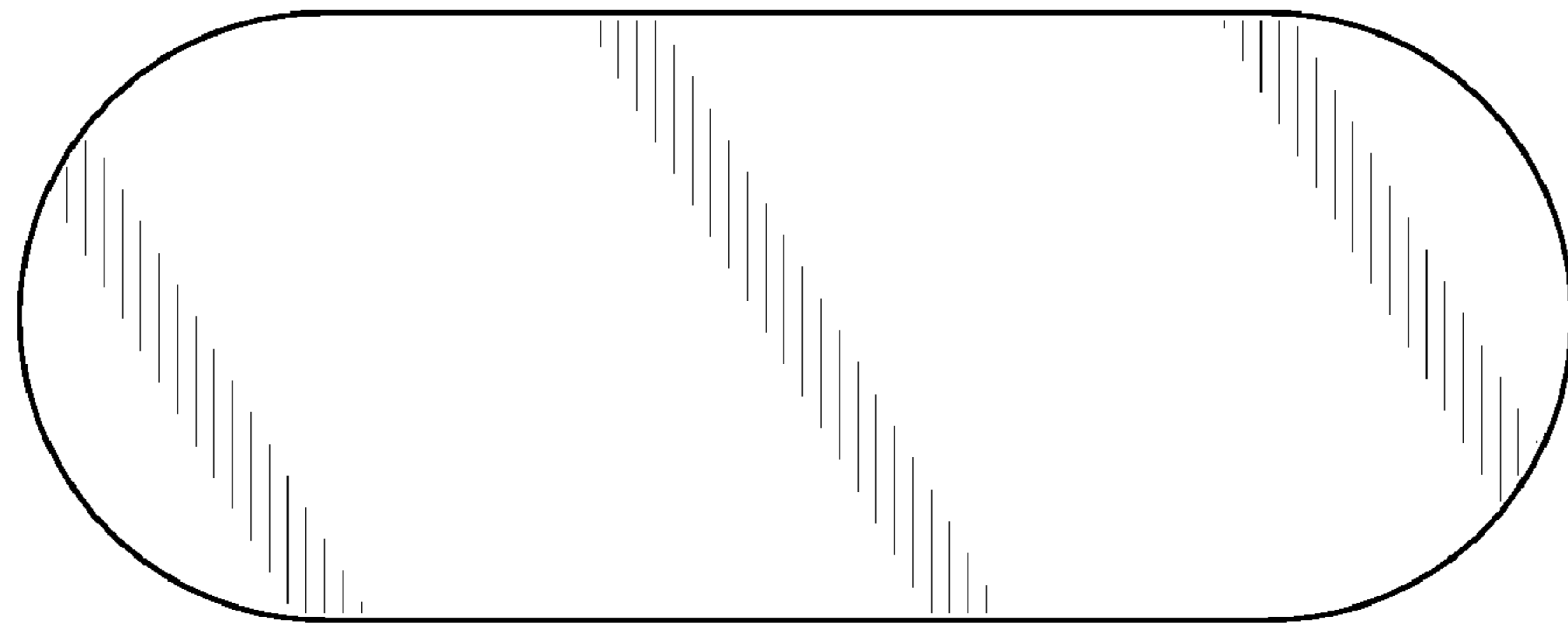

FIG. 9

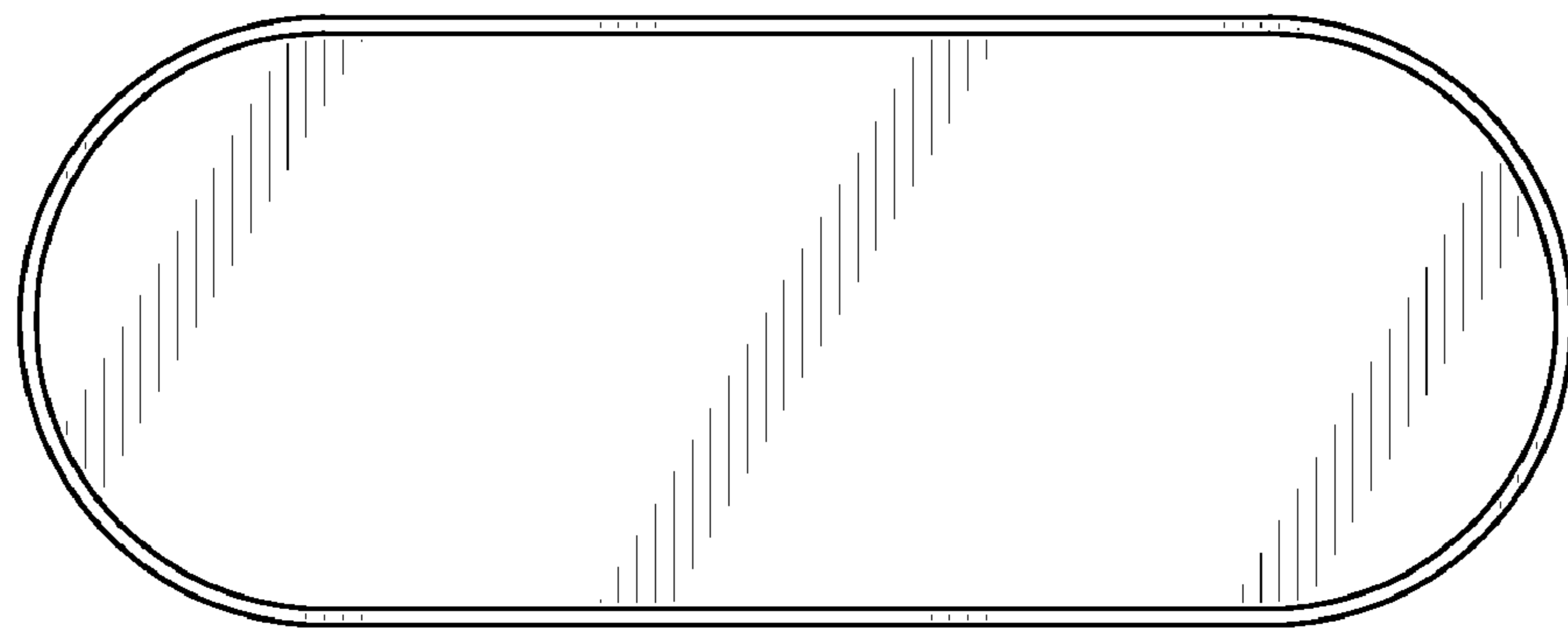

FIG. 10