



US00D630887S

(12) **United States Design Patent**  
**Olivari**

(10) **Patent No.:** **US D630,887 S**  
(45) **Date of Patent:** **\*\* Jan. 18, 2011**

(54) **FLEXIBLE HANDLE FOR CONTAINERS**

(75) Inventor: **Christian Olivari**, Redondo Beach, CA (US)

(73) Assignee: **Dart Industries Inc.**, Orlando, FL (US)

(\*\*) Term: **14 Years**

(21) Appl. No.: **29/349,337**

(22) Filed: **Mar. 25, 2010**

(51) **LOC (9) Cl.** ..... **07-02**

(52) **U.S. Cl.** ..... **D7/393**

(58) **Field of Classification Search** ..... D7/393,  
D7/394, 542, 610, 622, 701, 703, 705, 709;  
D3/315, 316, 318, 327, 328; D9/434, 443,  
D9/455, 752, 756; D34/28; D8/394-396;  
16/110.1, 114.1, 406; 206/150, 151, 203,  
206/503, 504, 510, 551, 820; 220/754, 758,  
220/759, 760; 294/27.1, 31.2, 33, 87.1, 87.2,  
294/137, 165, 170

See application file for complete search history.

(56) **References Cited**

**U.S. PATENT DOCUMENTS**

1,820,497 A	8/1931	Rose	
D187,247 S	2/1960	Tupper	
D188,553 S	8/1960	Tupper	
3,044,659 A	7/1962	Tupper	
3,092,410 A	6/1963	Diamantides	
3,194,460 A *	7/1965	Tupper	294/165
3,194,462 A *	7/1965	Tupper	294/170
D206,079 S	10/1966	Swett	
D237,589 S *	11/1975	Calvert	D9/752
D241,600 S	9/1976	Ashton	
D254,170 S	2/1980	Croyle et al.	
4,207,997 A *	6/1980	Croyle	294/137
D261,976 S	11/1981	Conti	
D272,316 S *	1/1984	Braun	D9/752
4,478,450 A *	10/1984	Picozza	294/31.2
D277,256 S	1/1985	Picozza	

4,505,506 A *	3/1985	Picozza	206/503
D282,337 S	1/1986	Picozza	
D305,959 S	2/1990	Laguerra	
D330,513 S	10/1992	Gilchrist	
5,676,252 A *	10/1997	Lillelund et al.	206/551
D389,018 S	1/1998	Lillelund et al.	
D413,800 S *	9/1999	Caparros et al.	D9/752
5,967,323 A	10/1999	Siragusa	
D423,349 S *	4/2000	Lyons et al.	D9/434
6,349,847 B1	2/2002	Mangla et al.	
D458,800 S	6/2002	Kotsonis	
D479,947 S	9/2003	Claypool	
D493,665 S *	8/2004	Warning	D7/393
D583,664 S *	12/2008	Franzone, Jr.	D9/434
2005/0167289 A1 *	8/2005	Borg	206/151
2007/0296231 A1 *	12/2007	Borg	294/87.2
2009/0223987 A1 *	9/2009	Wang	220/754

\* cited by examiner

*Primary Examiner*—Cynthia M Chin

(74) *Attorney, Agent, or Firm*—John A. Doninger

(57) **CLAIM**

The ornamental design for a flexible handle for containers, as shown and described.

**DESCRIPTION**

FIG. 1 is a top, right side and front perspective view of a flexible handle for containers showing my new design;

FIG. 2 is a bottom, left side and rear perspective view thereof;

FIG. 3 is front elevation view, the rear elevation being identical thereto;

FIG. 4 is a right side elevation view, the left side elevation being identical thereto;

FIG. 5 is a top plan view thereof;

FIG. 6 is a bottom plan view thereof; and,

FIG. 7 is a top perspective view showing the flexible handle in position for carrying two containers shown in phantom lines.

**1 Claim, 3 Drawing Sheets**

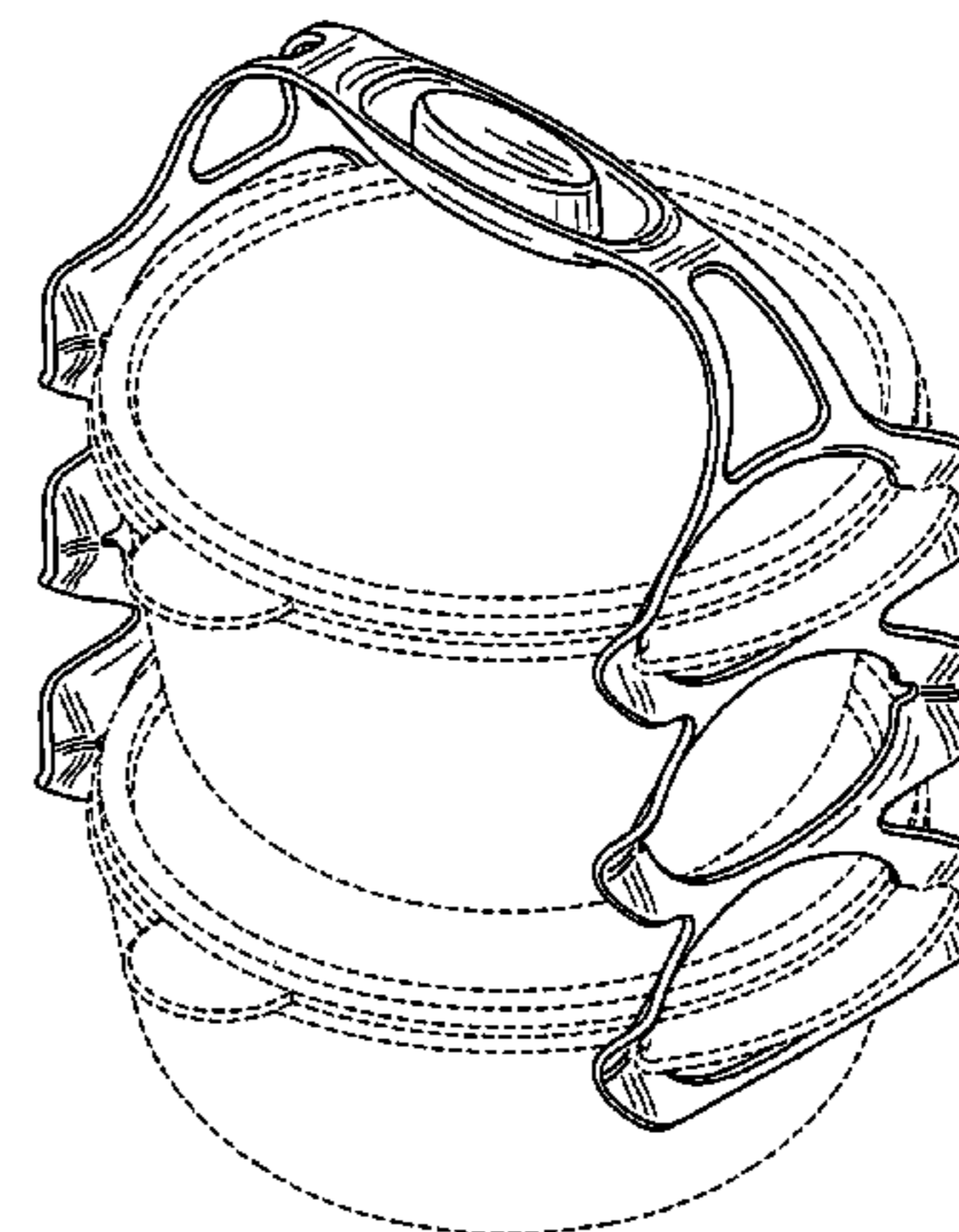
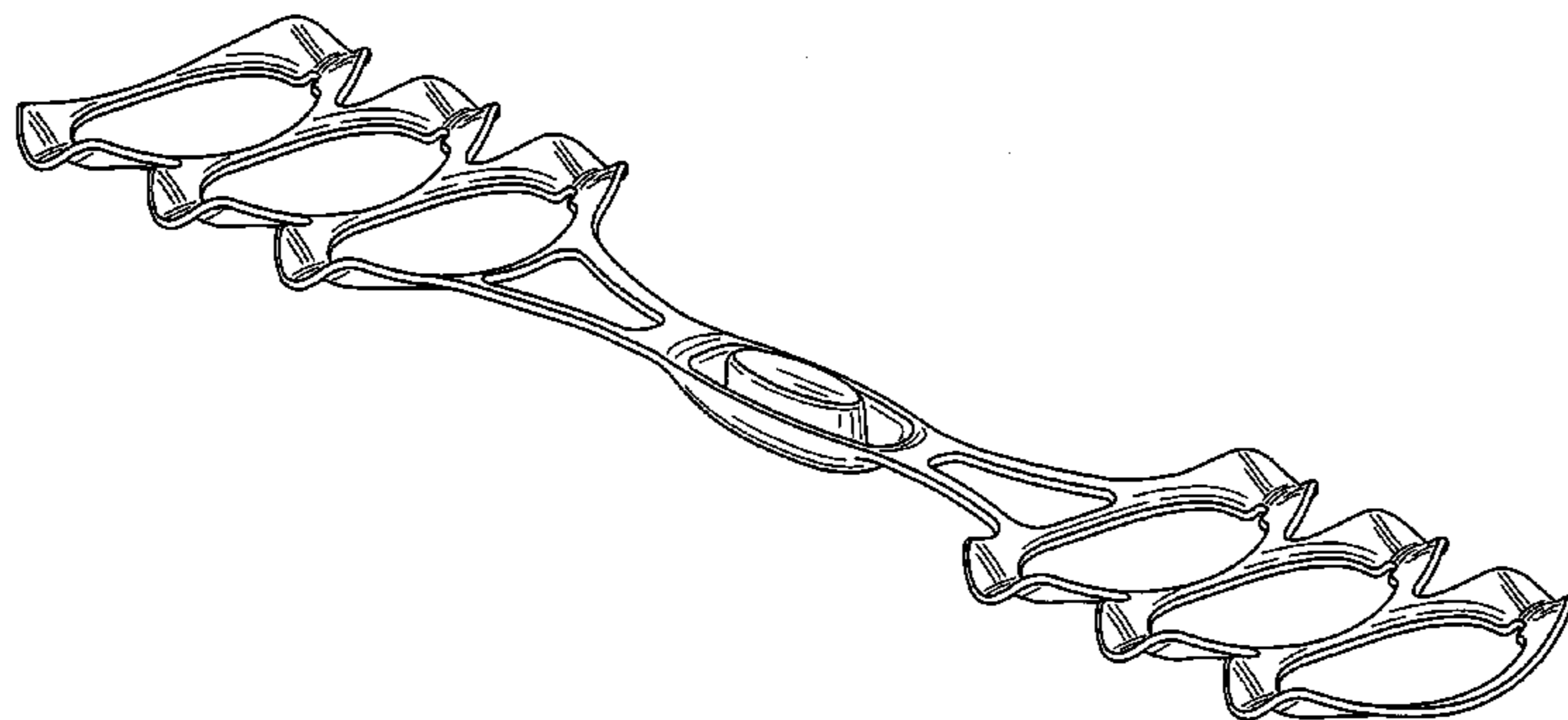

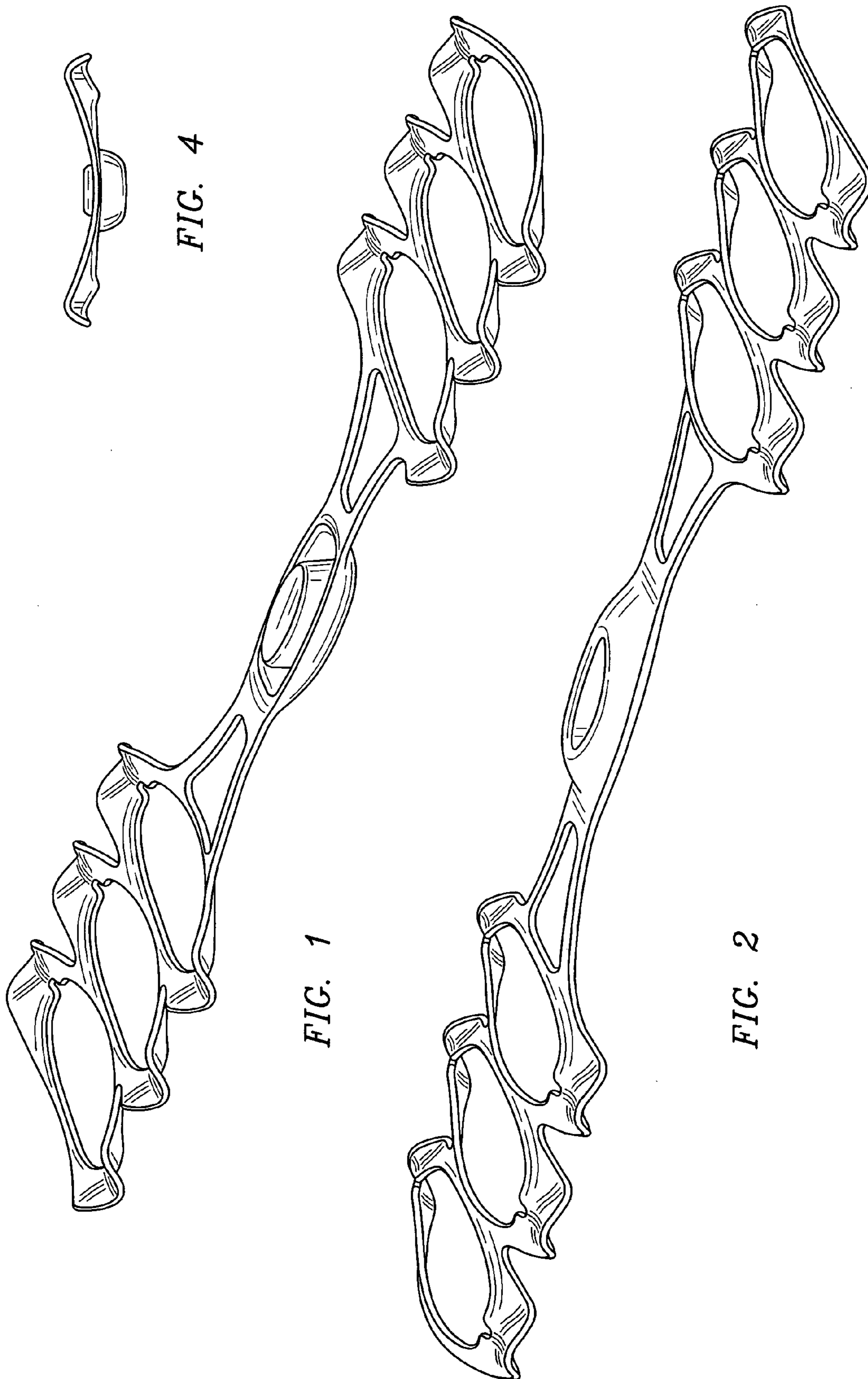



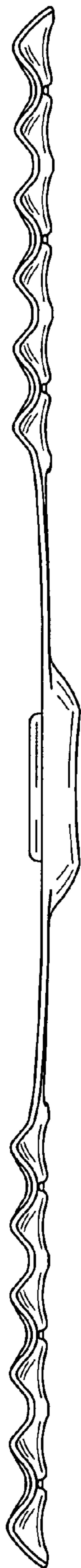

FIG. 3

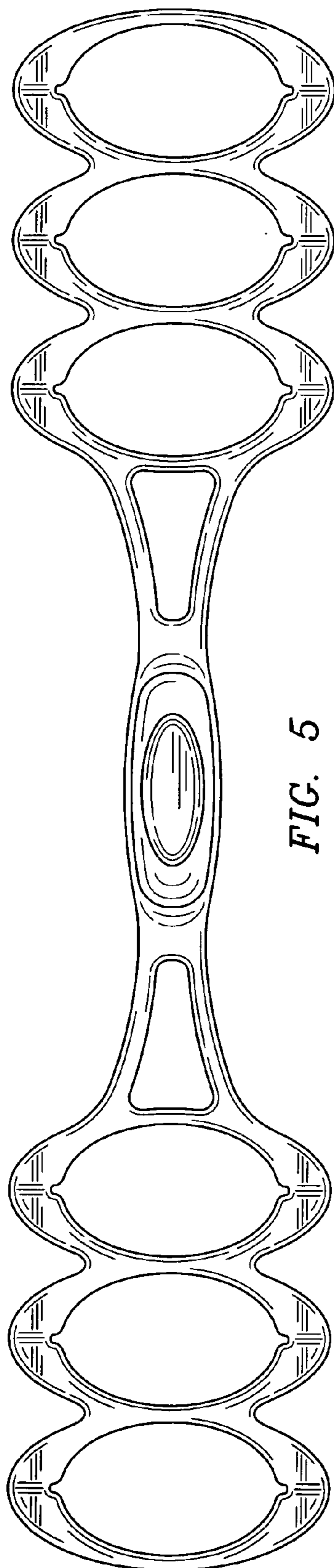

FIG. 5

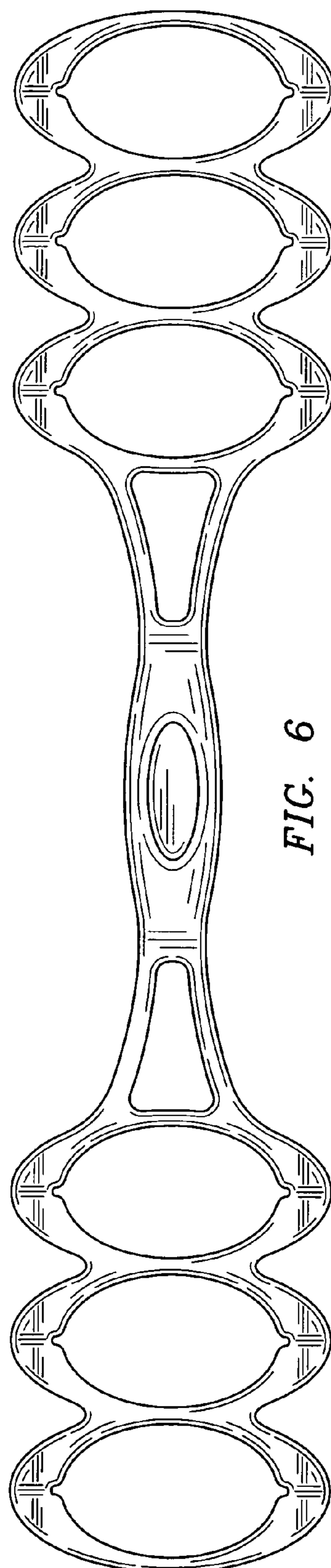
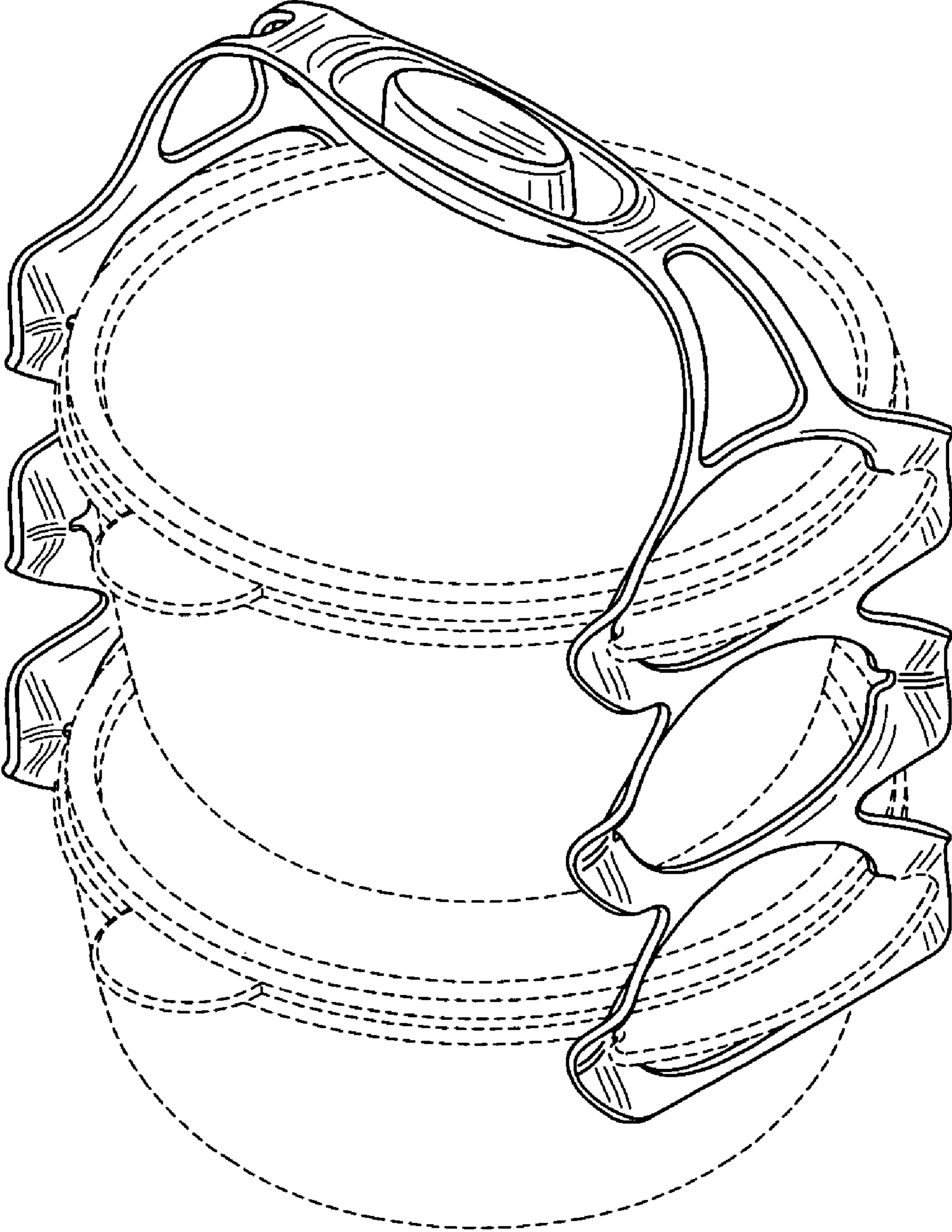

FIG. 6



*FIG. 7*