



US00D630856S

(12) **United States Design Patent**
Arvinte et al.

(10) **Patent No.:** **US D630,856 S**
(45) **Date of Patent:** **** *Jan. 18, 2011**

(54) **ROLLER FRAME**
(75) Inventors: **Romeo Arvinte**, Laval-des-Rapides (CA); **Francois Panfili**, Berthierville (CA); **Christian Michaud**, St-Ignace-de-Loyola (CA)

(73) Assignee: **A. Richard Tools Co./Outlis A. Richard Co.**, Bertheierville, Quebec (CA)

(*) Notice: This patent is subject to a terminal disclaimer.

(**) Term: **14 Years**

(21) Appl. No.: **29/328,699**

(22) Filed: **Dec. 1, 2008**

Related U.S. Application Data

(63) Continuation-in-part of application No. 29/317,459, filed on Apr. 30, 2008, now Pat. No. Des. 584,059.

(30) **Foreign Application Priority Data**

Nov. 28, 2008 (CA) 128799

(51) **LOC (9) Cl.** **08-05**

(52) **U.S. Cl.** **D4/122**

(58) **Field of Classification Search** D4/122, D4/199; D6/317, 566; D8/370, 373, 107, D8/303; 15/27, 230.11, 143.1; 211/106, 211/106.01; 248/302; 401/197; 492/13, 492/16, 17, 19; 16/422, 430, 431, 902, DIG. 12, 16/DIG. 18, DIG. 19

See application file for complete search history.

(56) **References Cited**

U.S. PATENT DOCUMENTS

5,345,648 A 9/1994 Graves
6,349,451 B1 2/2002 Newman et al.
6,438,788 B1 8/2002 Gartner
D473,055 S 4/2003 Mann
6,629,331 B2 10/2003 Panfili et al.
7,028,365 B2 4/2006 Martin et al.
D584,059 S * 1/2009 Arvinte et al. D4/122
2002/0073500 A1 6/2002 Pavlou

FOREIGN PATENT DOCUMENTS

DE 3903519 8/1990

FR 2832081 A1 * 5/2003
GB 2446817 A * 8/2008

OTHER PUBLICATIONS

CA 50246 Industrial Design Registration (Rota Cota Pty. Ltd.), Sep. 13, 1982, [online], [retrieved on Aug. 16, 2008]. Retrieved from the Industrial Design Database of the Canadian Intellectual Property Office using the Internet: <URL: http://www.cipo.ic.gc.ca>.*

* cited by examiner

Primary Examiner—Melanie H Tung

Assistant Examiner—Lavone D Tabor

(74) *Attorney, Agent, or Firm*—Fish & Richardson P.C.

(57) **CLAIM**

The ornamental design for a roller frame, as shown and described.

DESCRIPTION

FIG. 1 is a top perspective view of a roller frame showing our new design.

FIG. 2 is another top perspective view thereof.

FIG. 3 is a top plan view thereof.

FIG. 4 is a right elevational side view thereof.

FIG. 5 is a left elevational side view thereof.

FIG. 6 is a front elevational view thereof.

FIG. 7 is a rear elevational view thereof.

FIG. 8 is a bottom plan view thereof.

FIG. 9 is a top perspective view of a roller frame showing a variant of our new design.

FIG. 10 is another top perspective view thereof.

FIG. 11 is a top plan view thereof.

FIG. 12 is a right elevational side view thereof.

FIG. 13 is a left elevational side view thereof.

FIG. 14 is a front elevational view thereof.

FIG. 15 is a rear elevational view thereof; and,

FIG. 16 is a bottom plan view thereof.

1 Claim, 14 Drawing Sheets

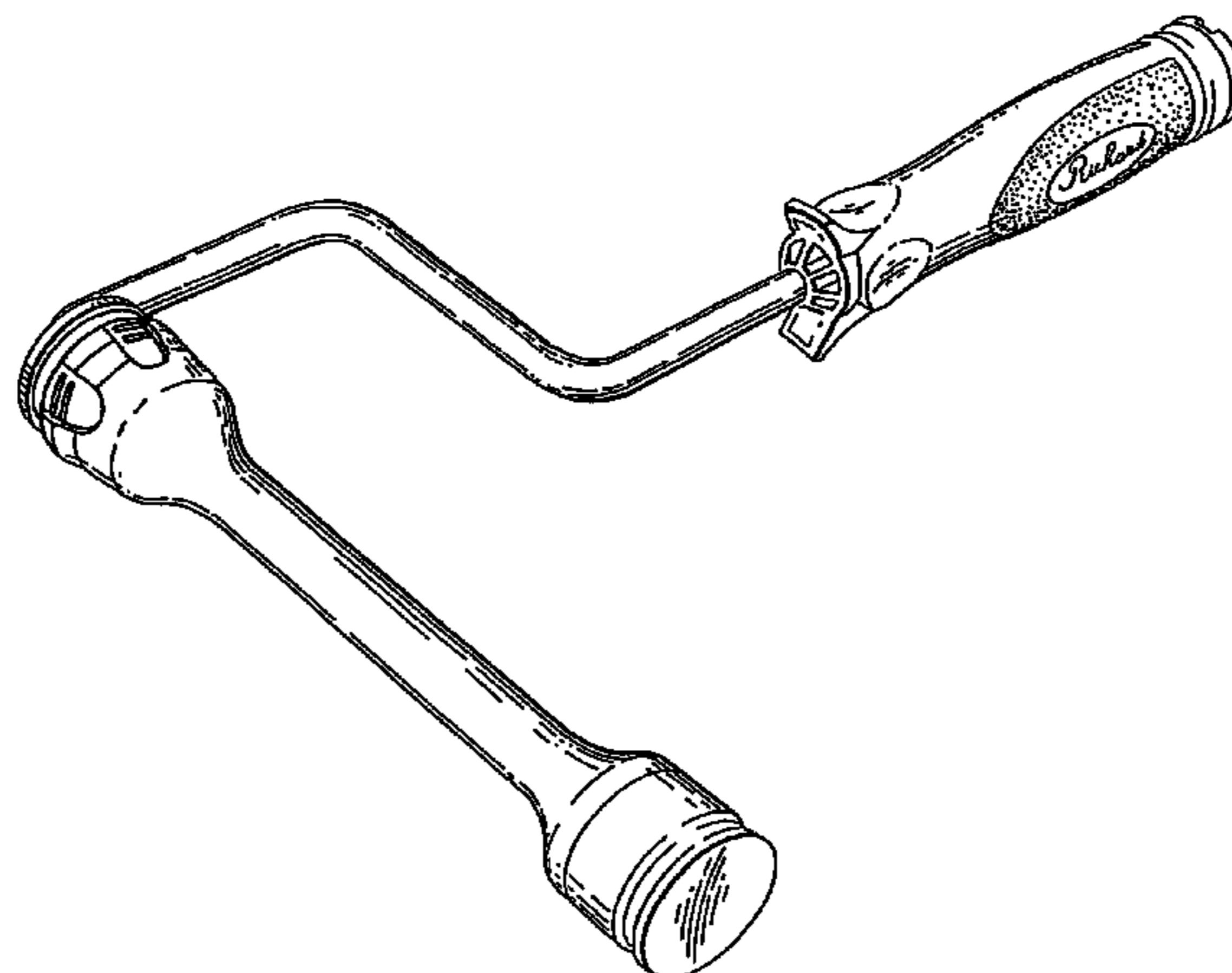

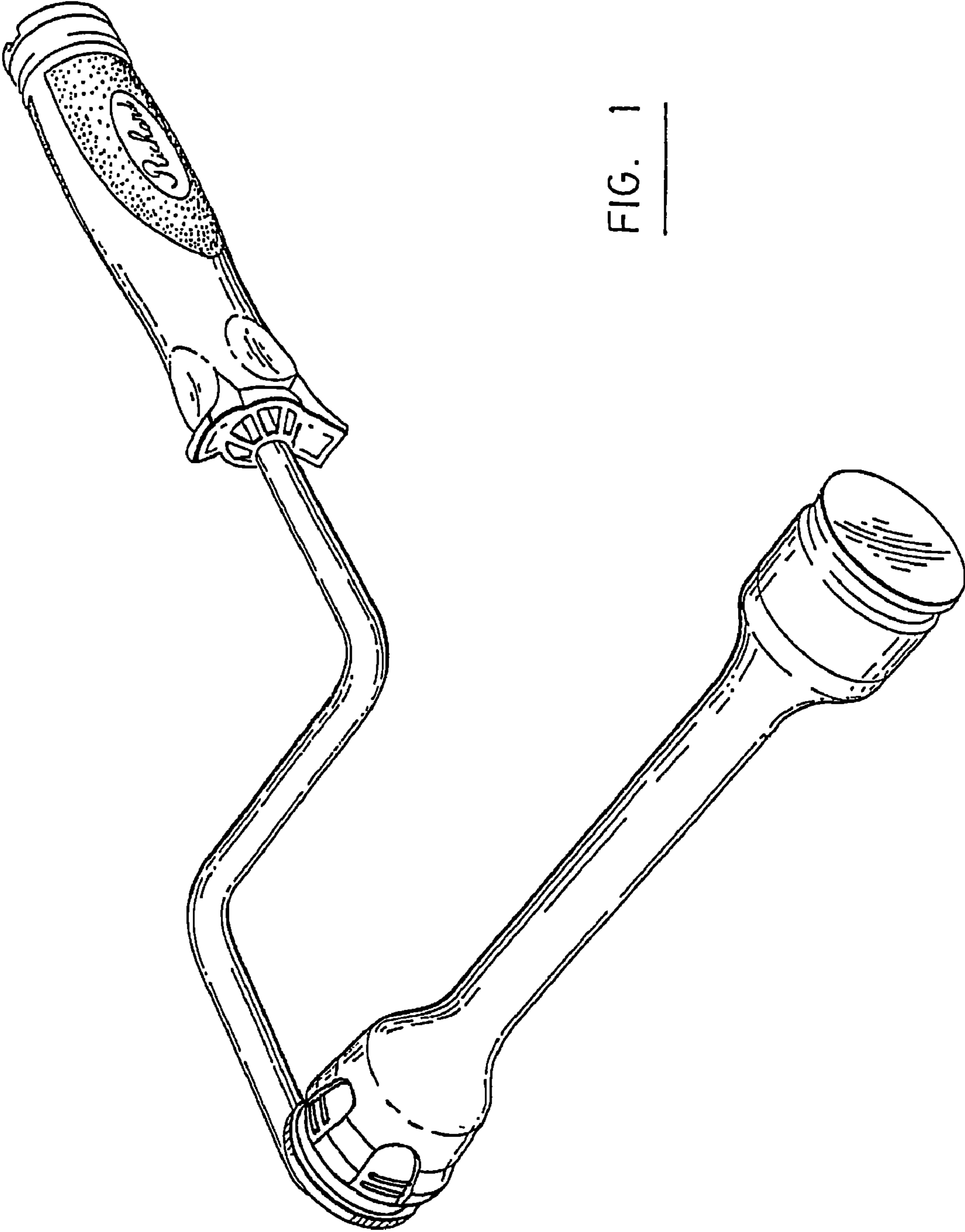

FIG. 1

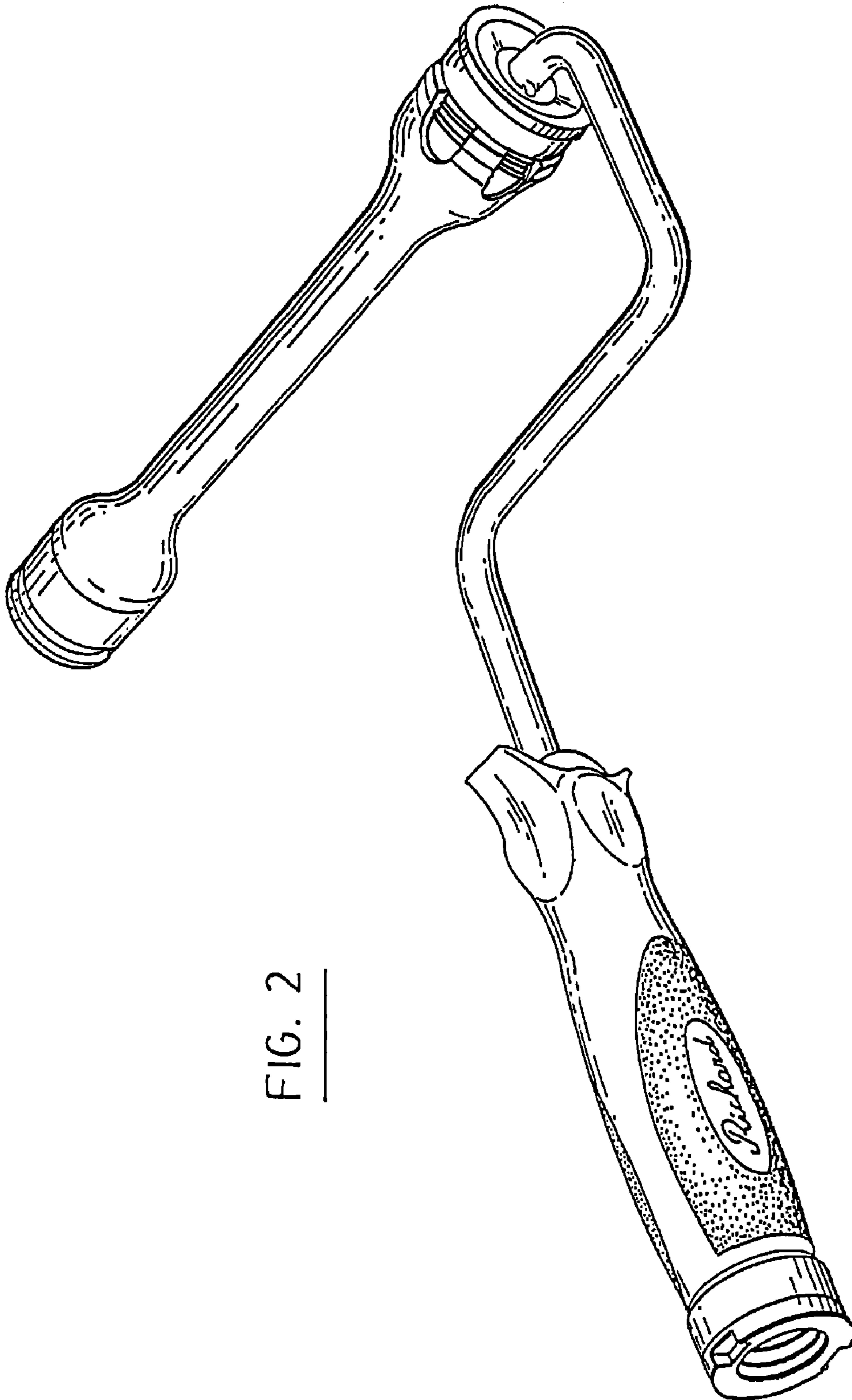

FIG. 2

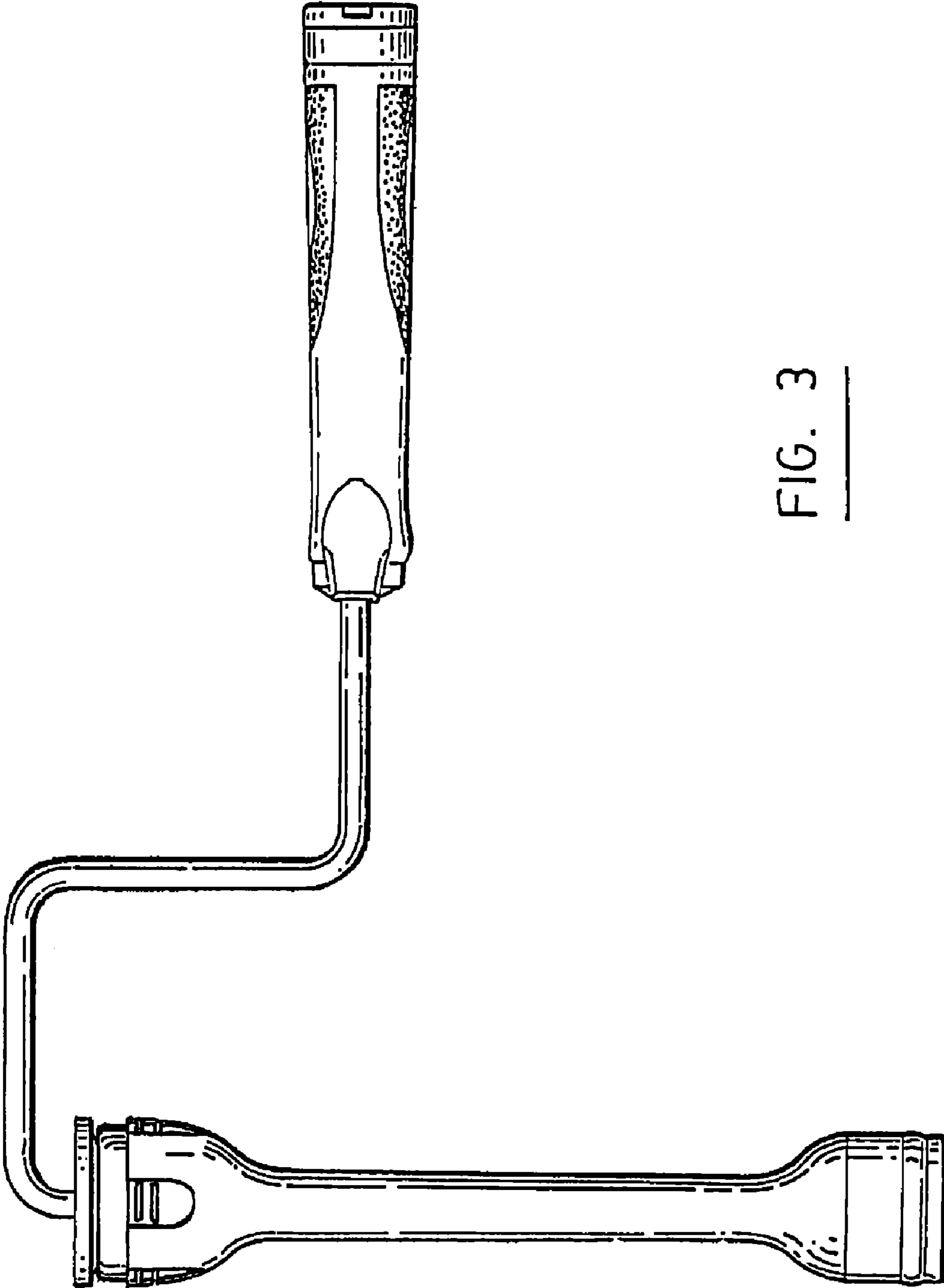

FIG. 3

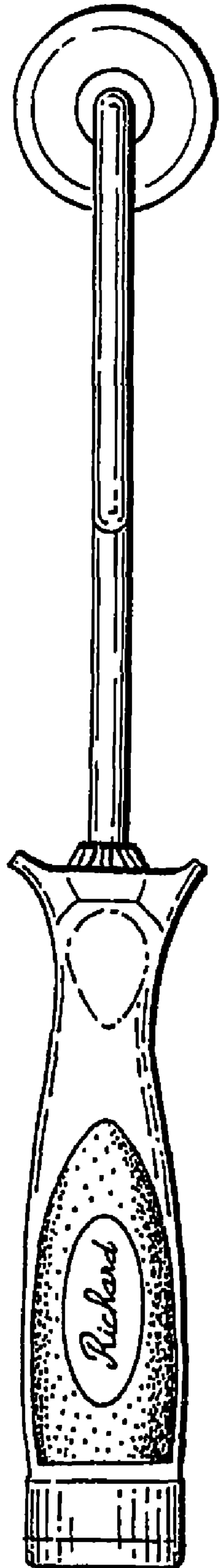

FIG. 4

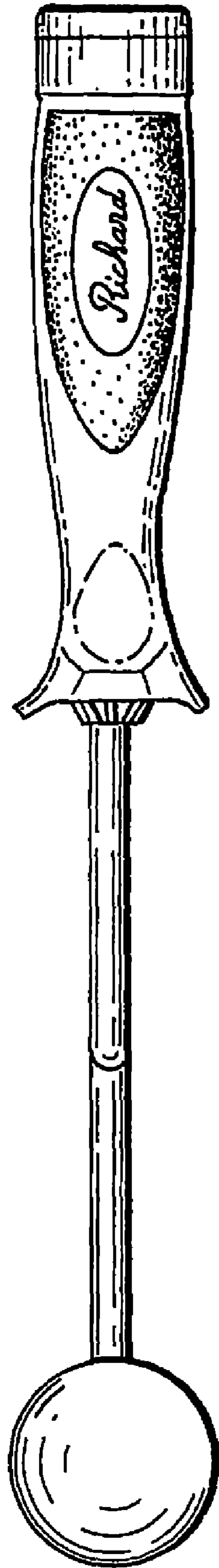

FIG. 5

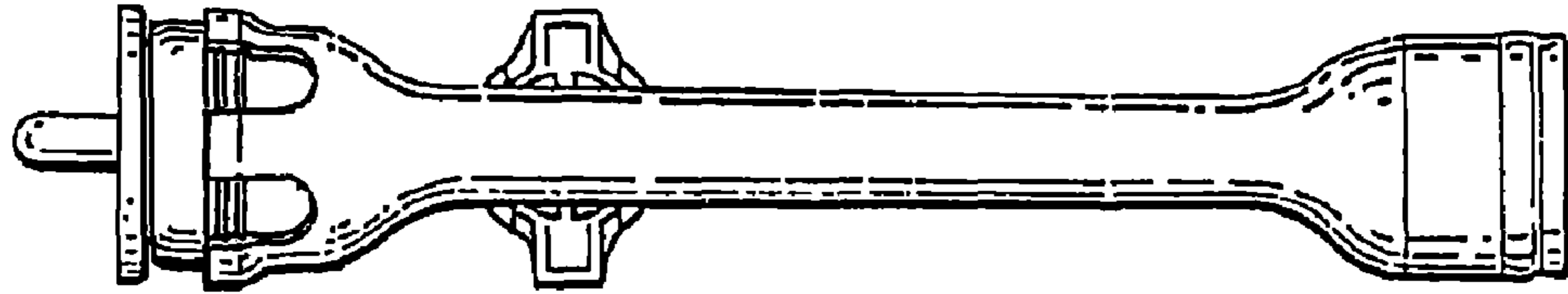

FIG. 6

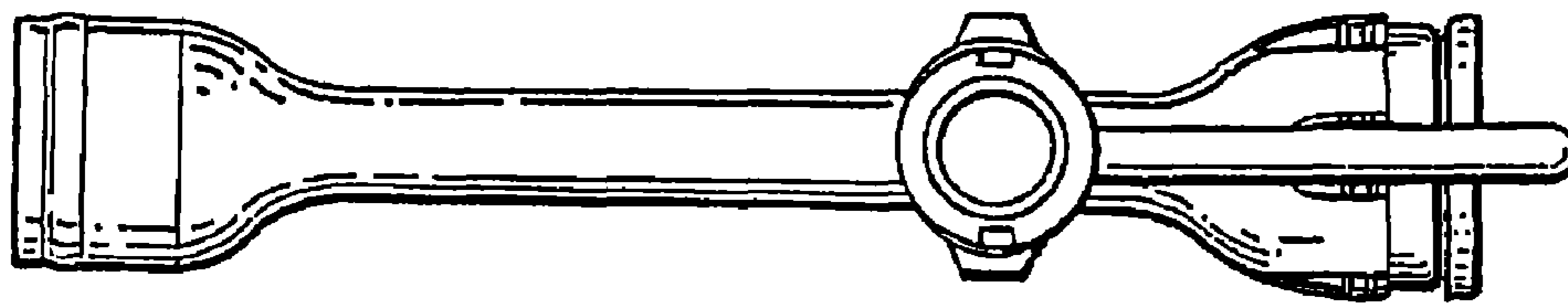

FIG. 7

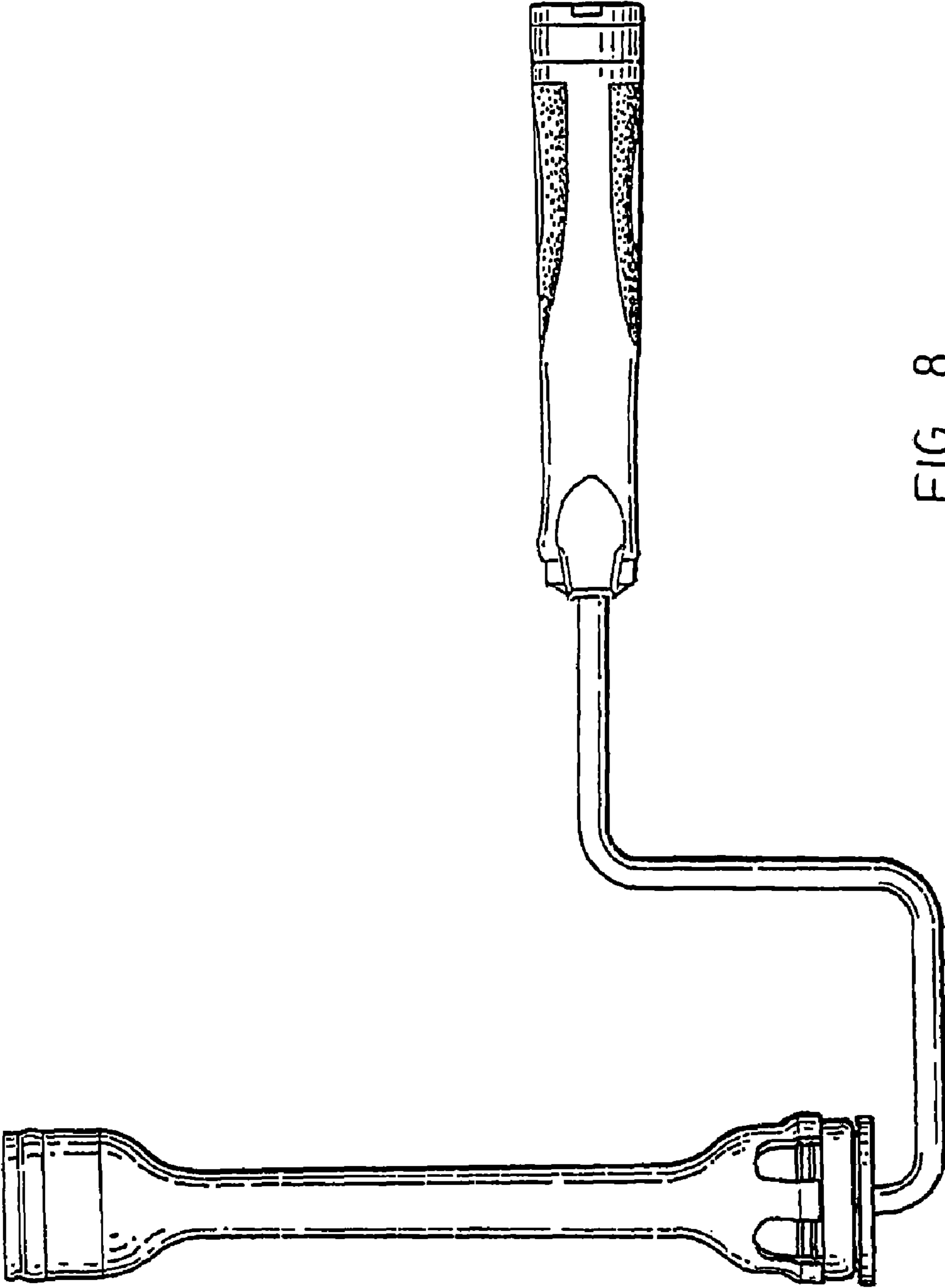

FIG. 8

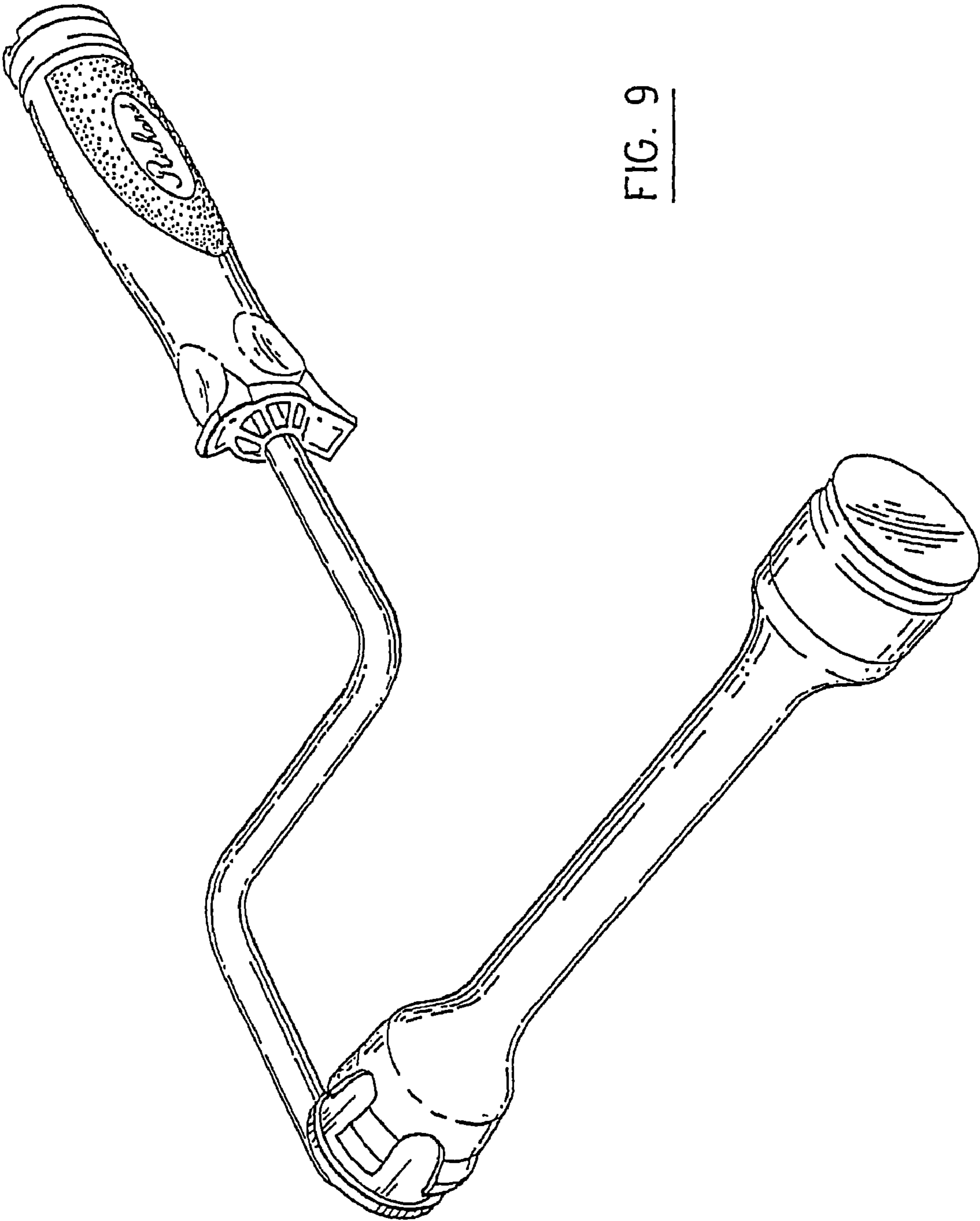

FIG. 9

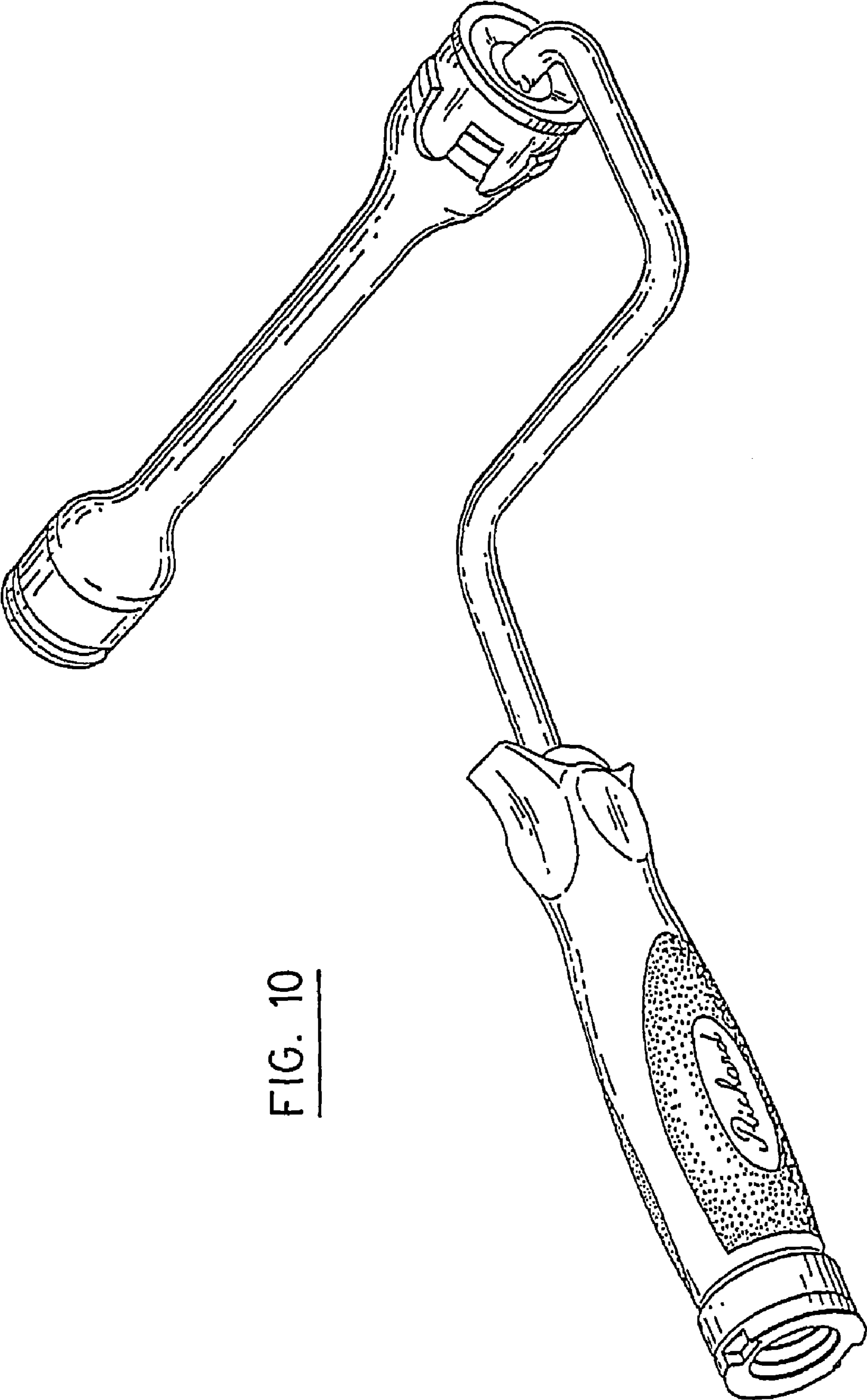

FIG. 10

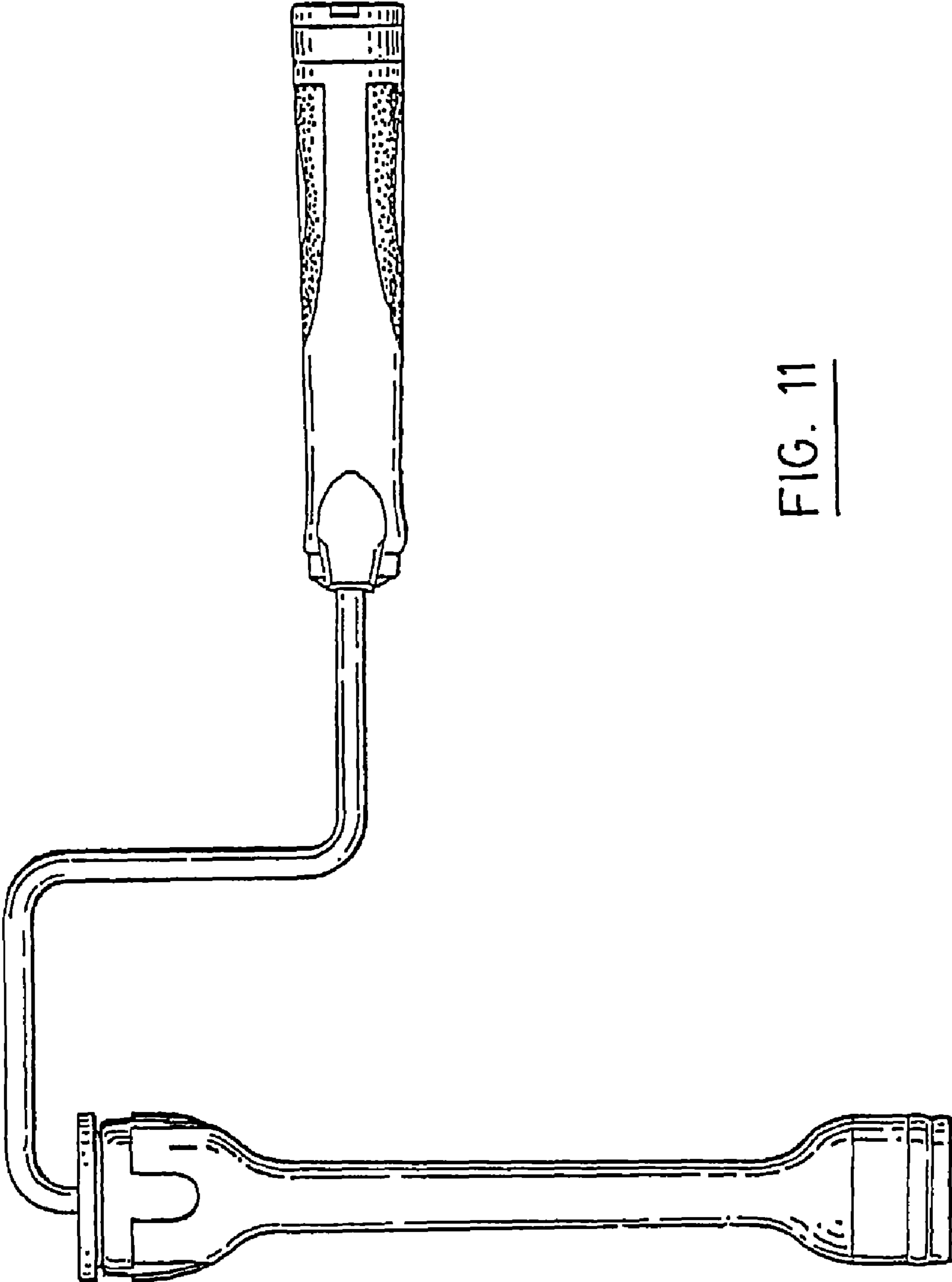

FIG. 11

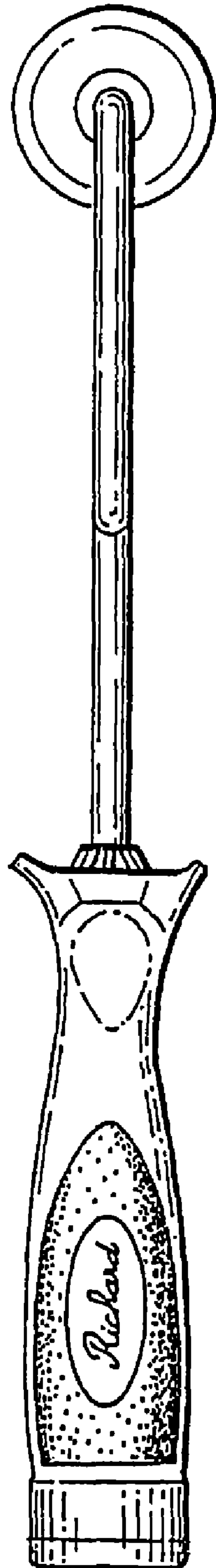

FIG. 12

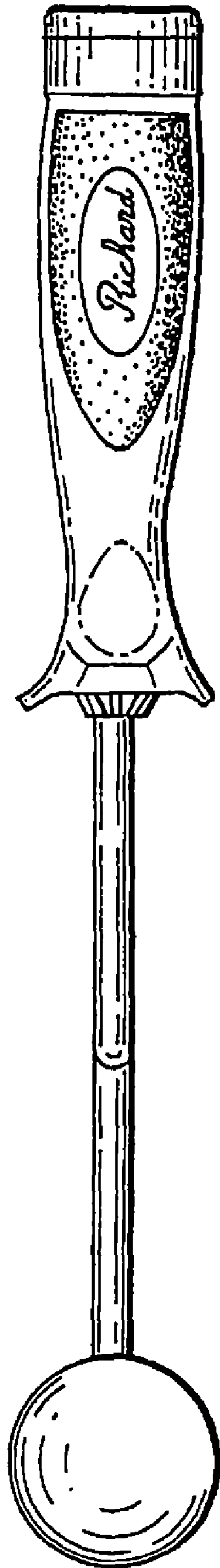

FIG. 13

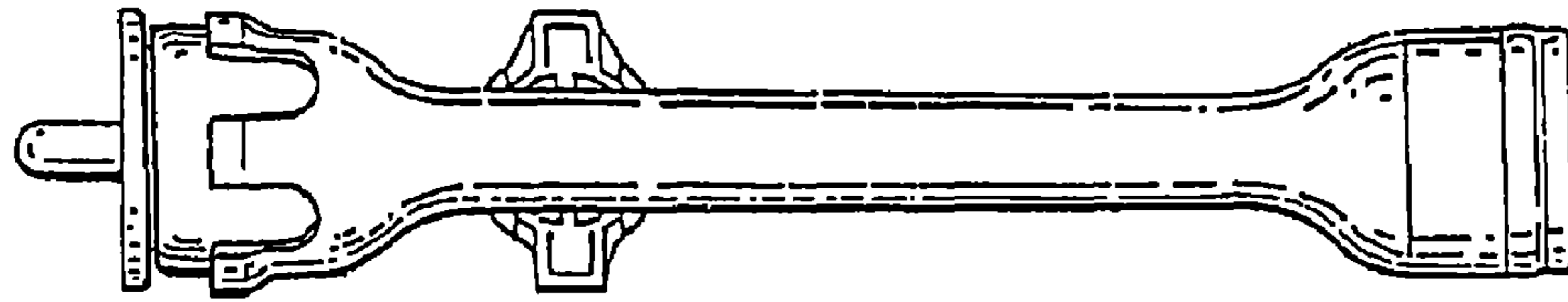

FIG. 14

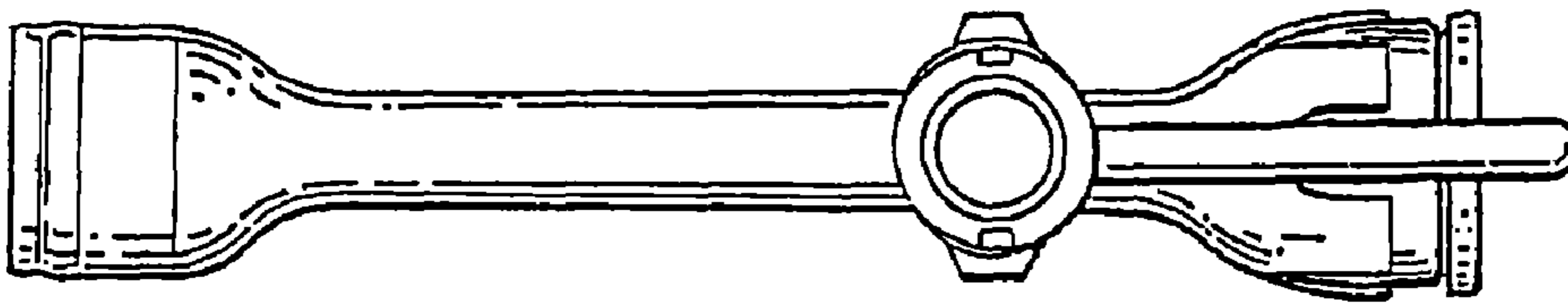

FIG. 15

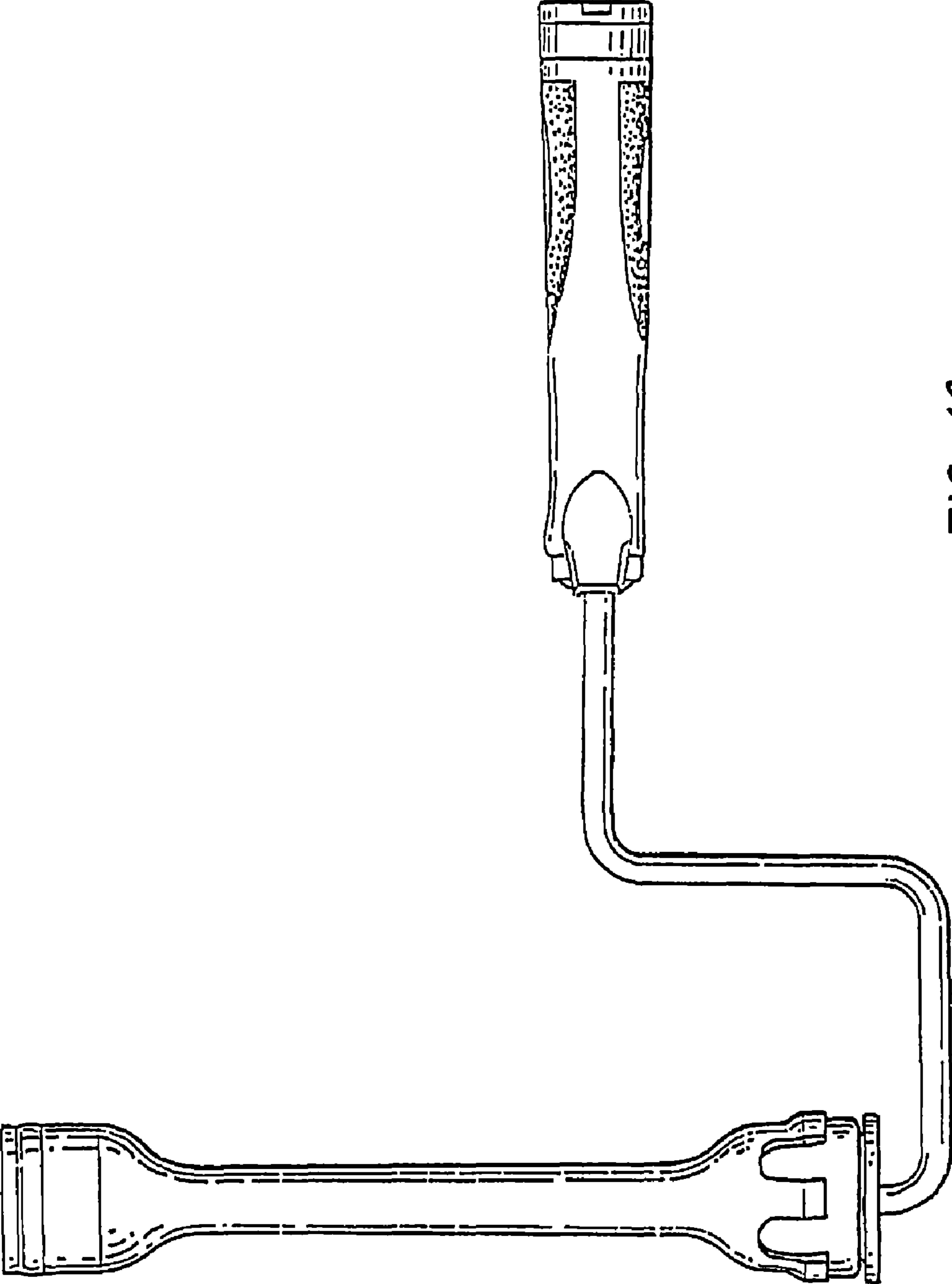

FIG. 16