



US00D630807S

(12) **United States Design Patent**
Song et al.

(10) **Patent No.:** **US D630,807 S**

(45) **Date of Patent:** **** Jan. 11, 2011**

(54) **LAUNDRY DRYER**

(75) Inventors: **Seung Hyun Song**, Seoul (KR); **Tae Woo Yoo**, Seoul (KR); **Ki Hyuk Kim**, Incheon (KR); **Min Jung You**, Seoul (KR); **Eun Young Jee**, Seoul (KR); **Hyoung Won Roh**, Seoul (KR)

(73) Assignee: **LG Electronics Inc.**, Seoul (KR)

(**) Term: **14 Years**

(21) Appl. No.: **29/346,685**

(22) Filed: **Nov. 4, 2009**

(30) **Foreign Application Priority Data**

Jun. 1, 2009 (KR) 30-2009-0023672

(51) **LOC (9) Cl.** **15-05**

(52) **U.S. Cl.** **D32/6**

(58) **Field of Classification Search** D32/5-6,
D32/8, 10, 1, 9; 34/132, 523-524, 597; 68/3 R,
68/5 R, 12.01, 12.08, 212

See application file for complete search history.

(56) **References Cited**

U.S. PATENT DOCUMENTS

D524,000	S	*	6/2006	Kim et al.	D32/6
D524,494	S	*	7/2006	Kim	D32/9
D526,453	S	*	8/2006	Jun	D32/6
D527,150	S	*	8/2006	Jun	D32/6
D542,487	S	*	5/2007	Jun	D32/6
D554,307	S	*	10/2007	Kim	D32/6
D556,394	S	*	11/2007	Kim	D32/6

D571,964	S	*	6/2008	Kim	D32/6
D575,012	S	*	8/2008	Rossetto et al.	D32/6
D575,464	S	*	8/2008	Rossetto et al.	D32/8

* cited by examiner

Primary Examiner—T. Chase Nelson
Assistant Examiner—Kathleen M Sims

(74) *Attorney, Agent, or Firm*—Birch, Stewart, Kolasch & Birch, LLP

(57) **CLAIM**

The ornamental design for a laundry dryer, as shown and described.

DESCRIPTION

FIG. 1 is a perspective view of a laundry dryer showing our new design;

FIG. 2 is a front view thereof;

FIG. 3 is a rear view thereof;

FIG. 4 is a left side view thereof;

FIG. 5 is a right side view thereof;

FIG. 6 is a top plan view thereof;

FIG. 7 is a bottom plan view thereof; and,

FIG. 8 is a perspective view showing an example of the usage of the present design in which the present design is used together with a washing machine.

The broken line showing of details in FIGS. 1-8 is included for the purpose of showing environmental portions of the washing machine and forms no part of the claimed design.

1 Claim, 8 Drawing Sheets

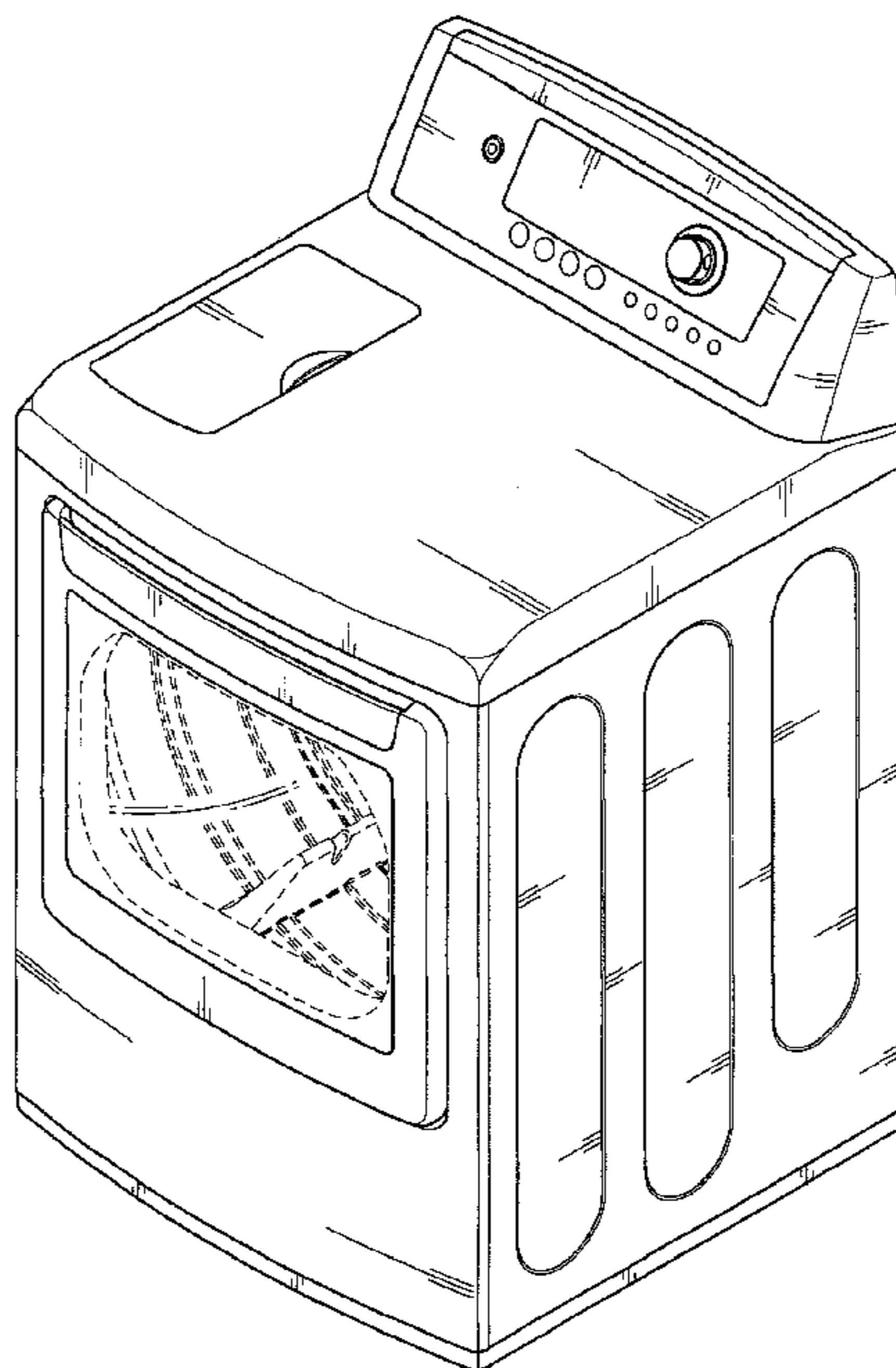
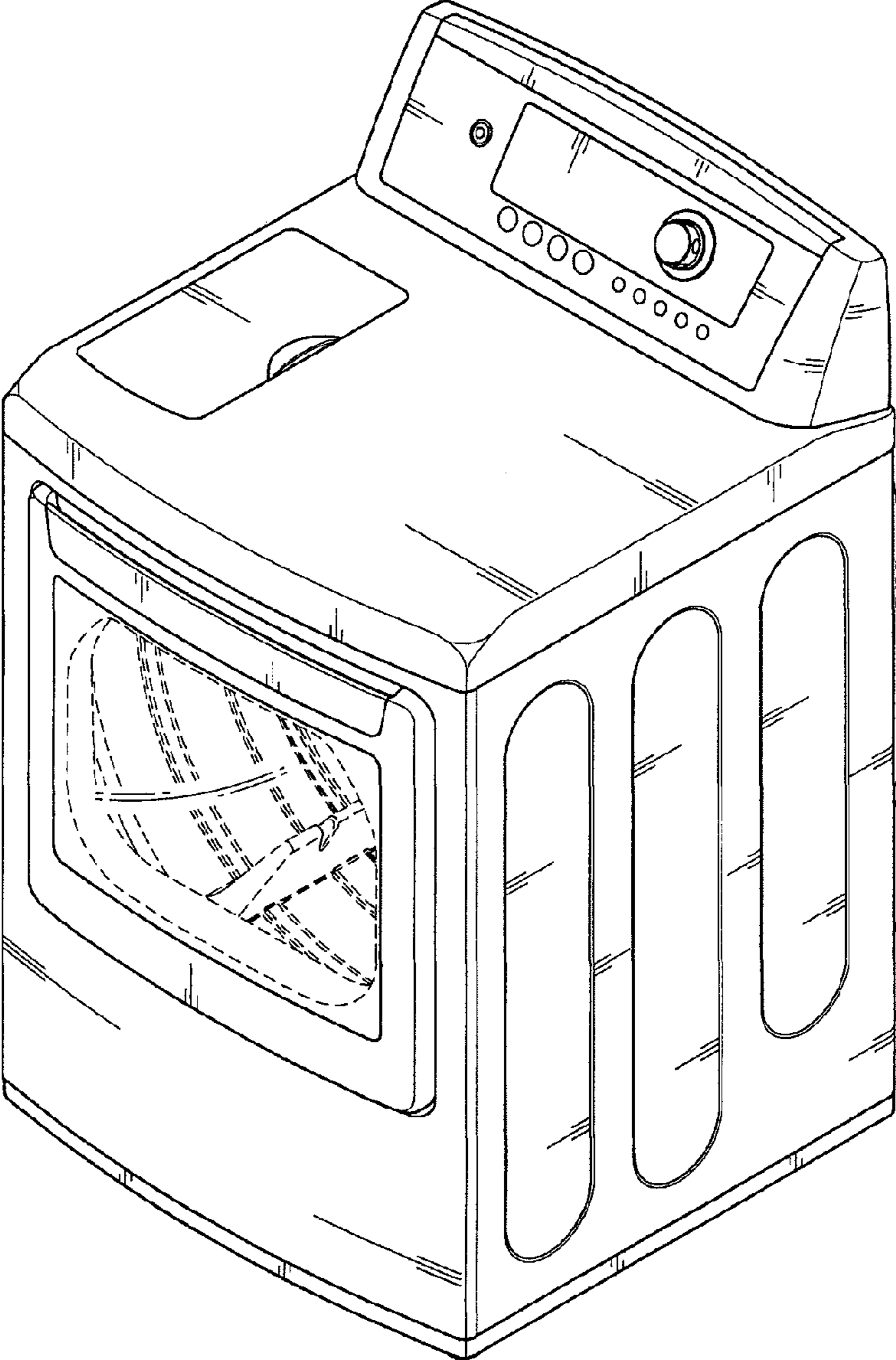

FIG. 1



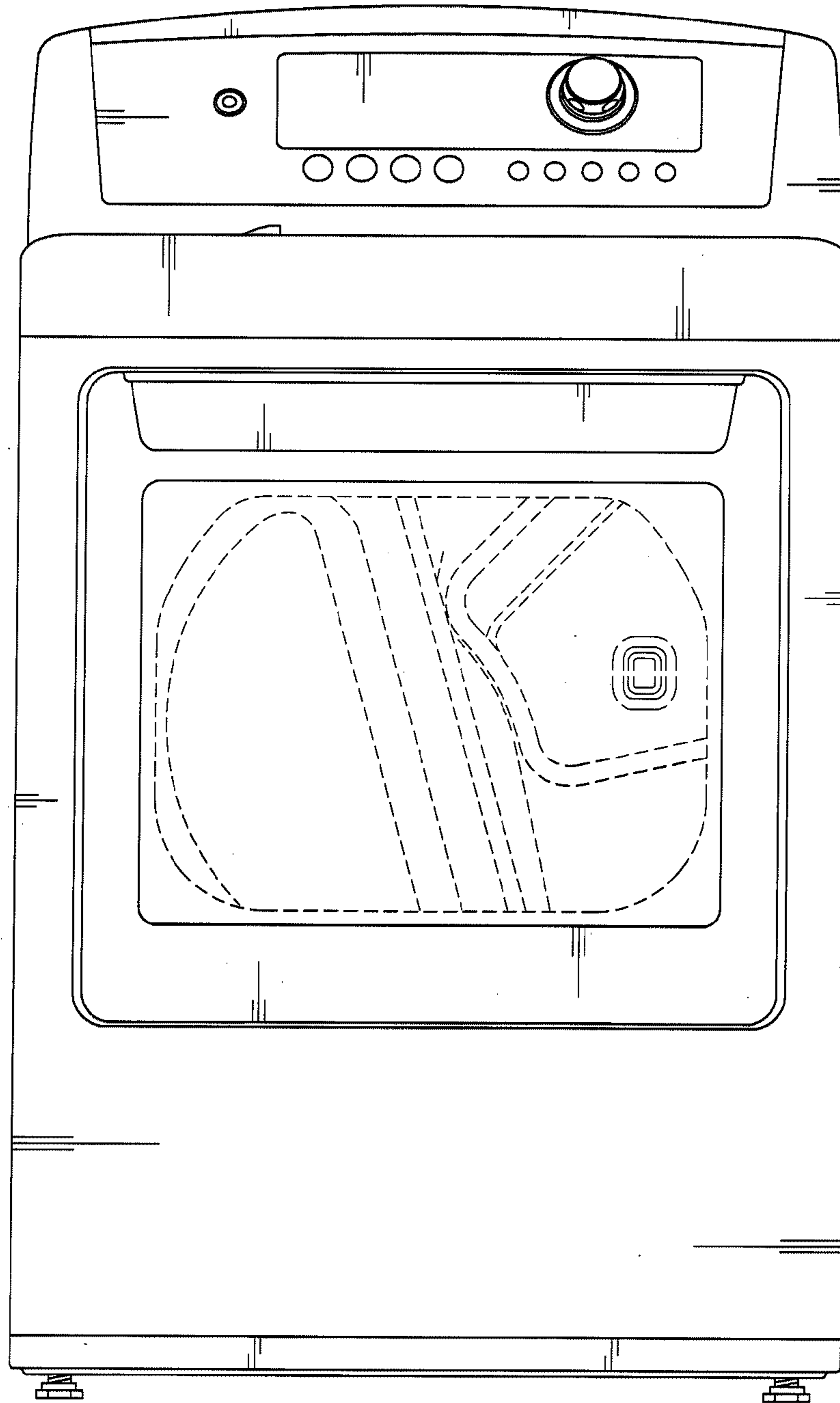

FIG. 3

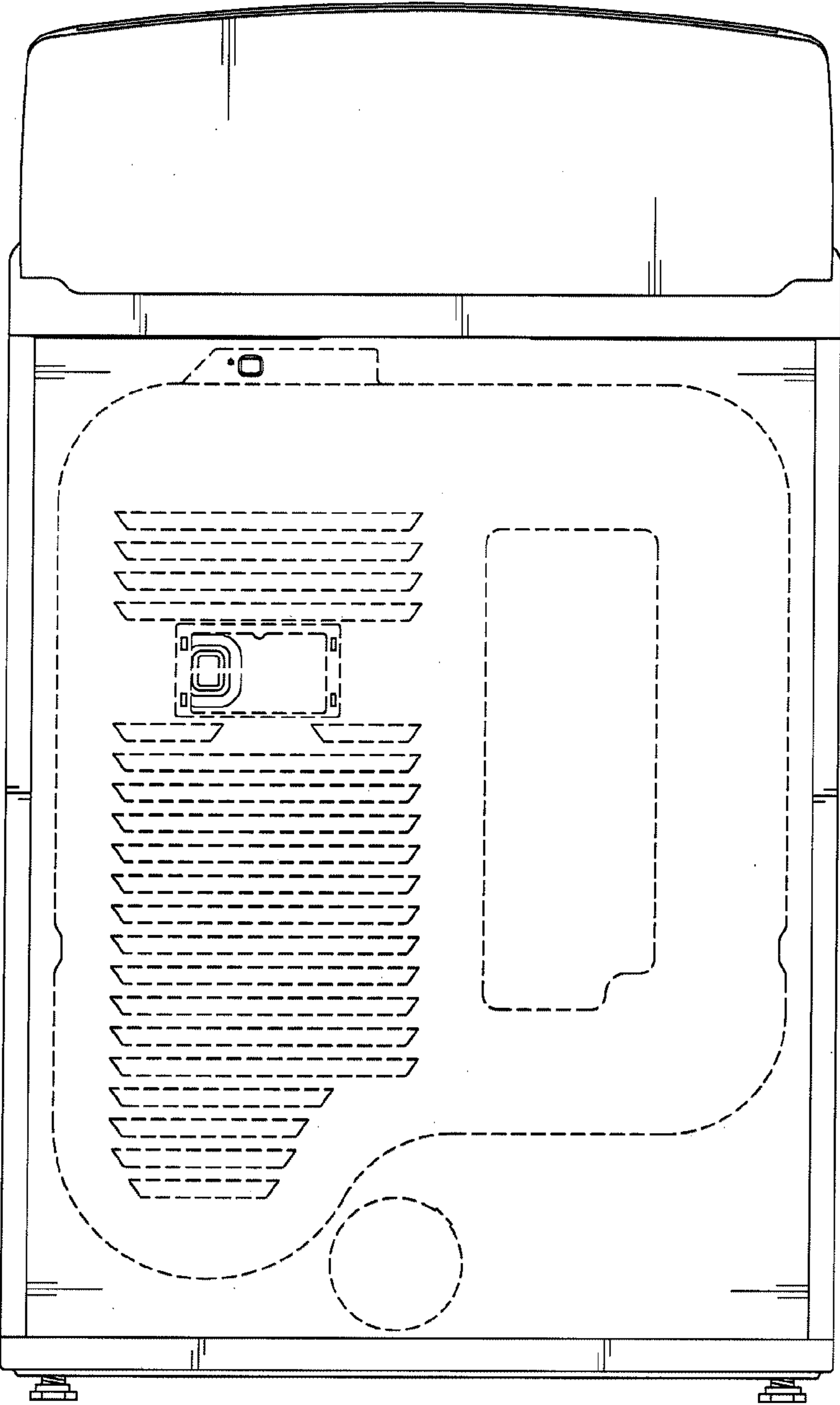

FIG. 4

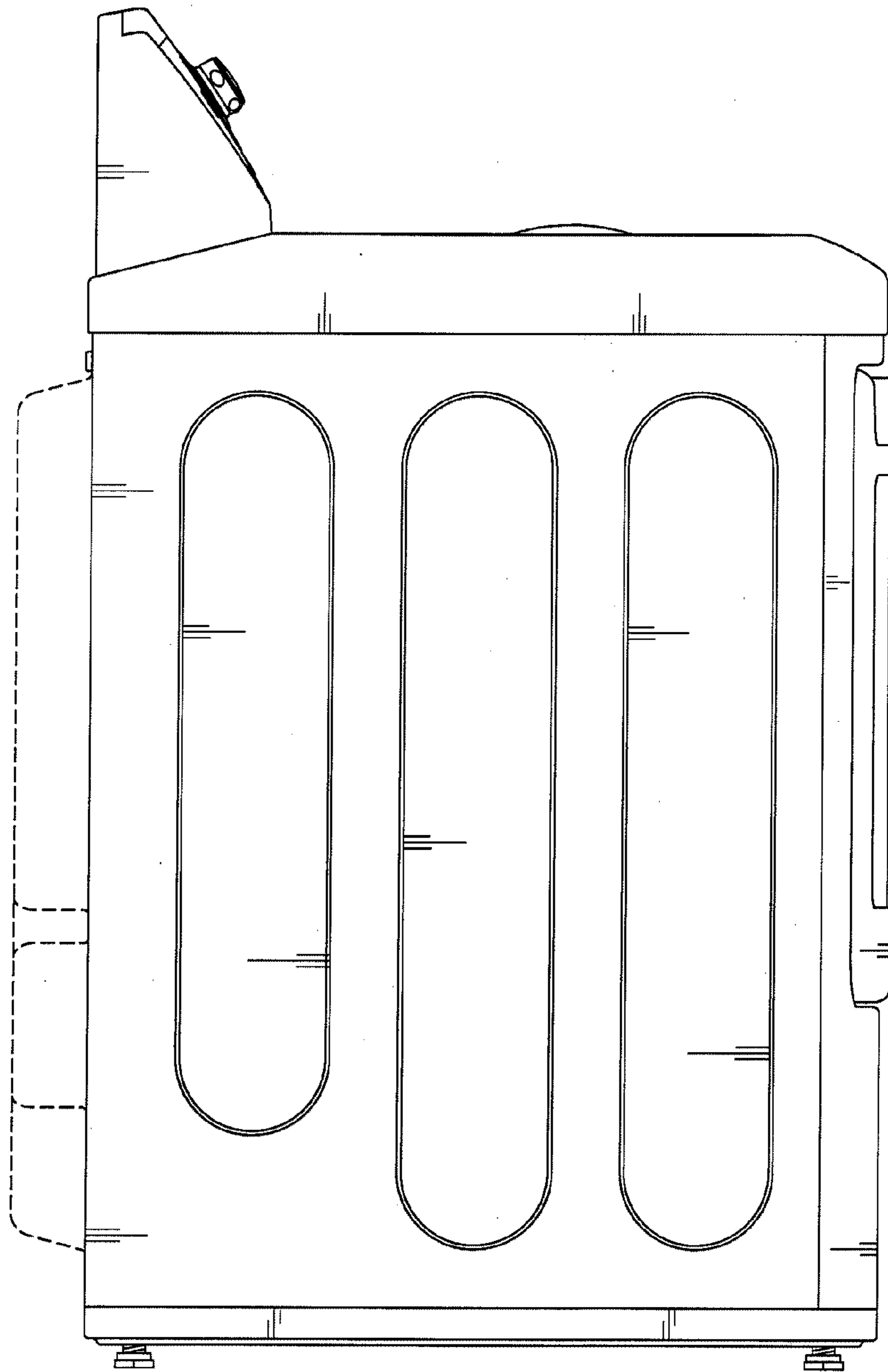

FIG. 5

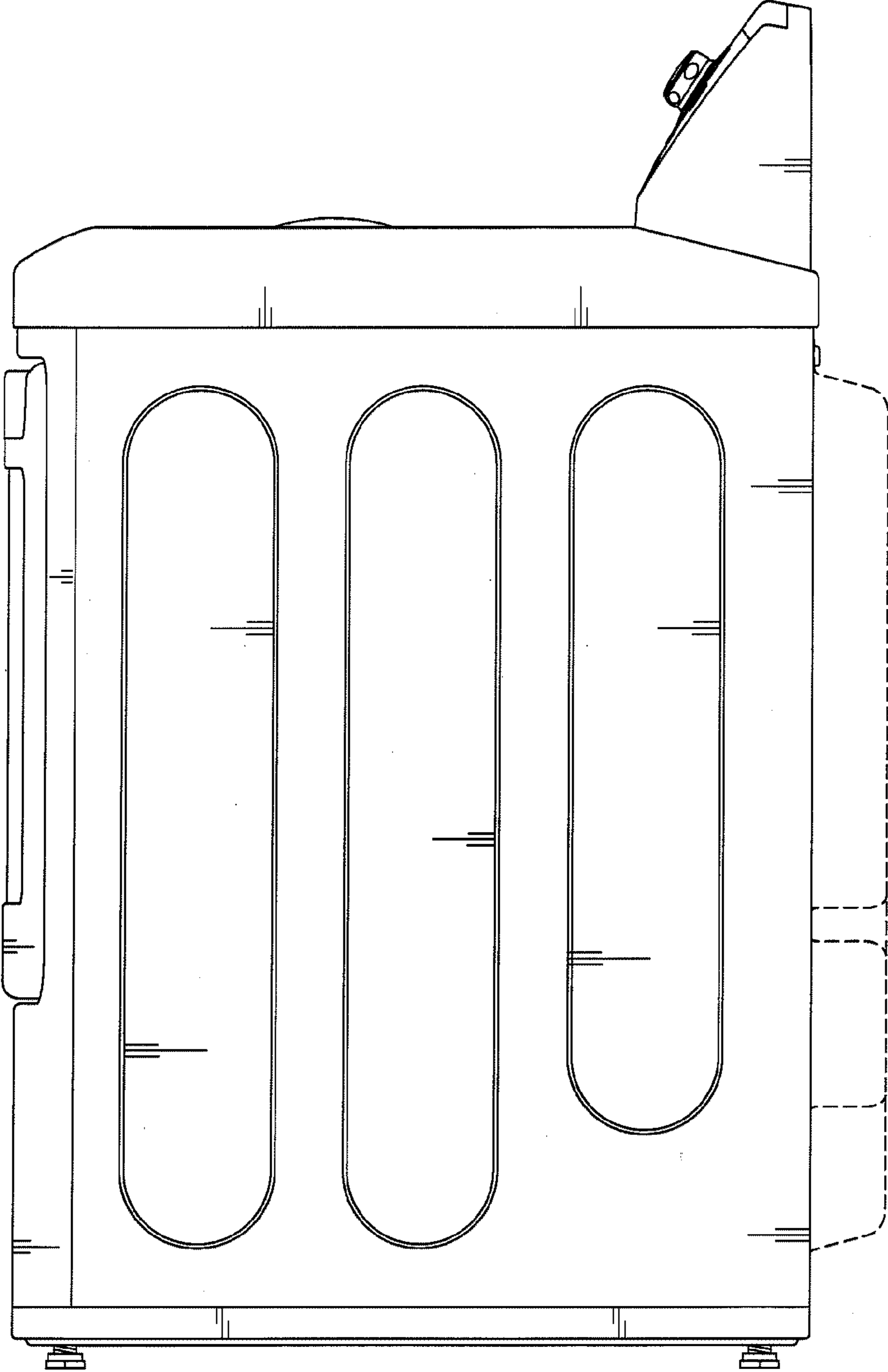

FIG. 6

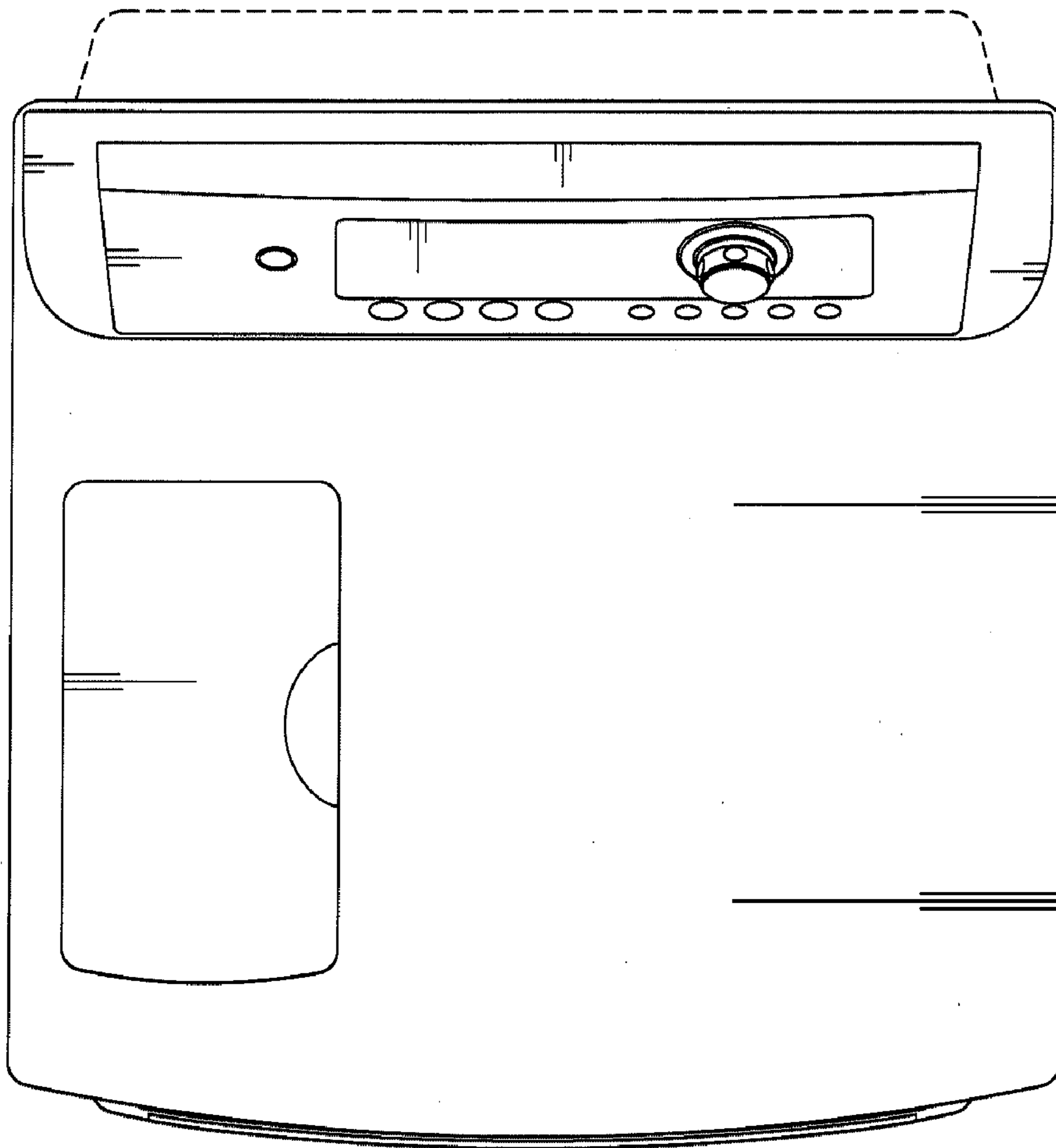

FIG. 7

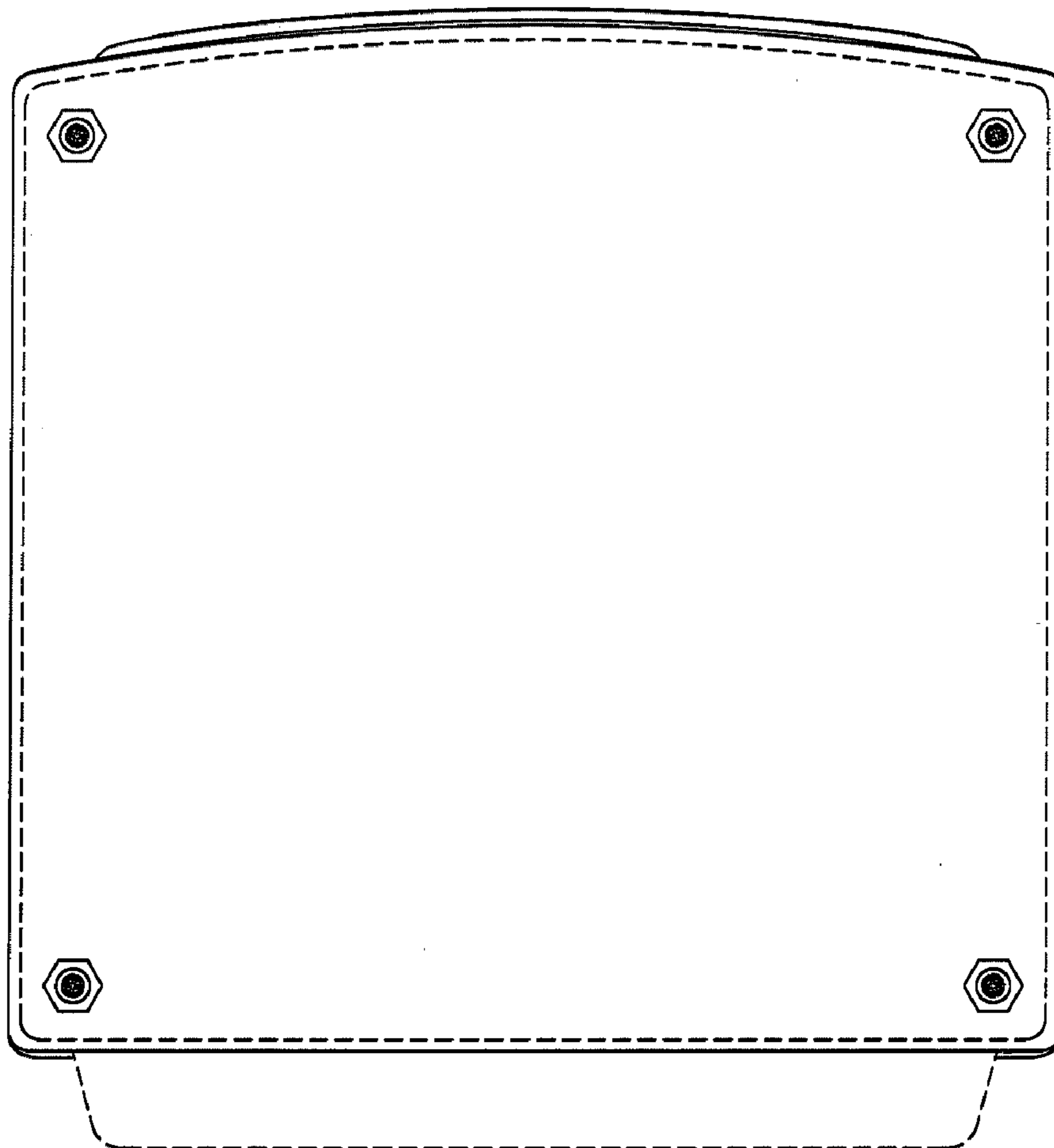

FIG. 8

