



US00D630806S

(12) **United States Design Patent**
Kaczmarek

(10) **Patent No.:** **US D630,806 S**
(45) **Date of Patent:** **** Jan. 11, 2011**

(54) **DISPLAY FOR A DISHWASHER**

(75) Inventor: **Wolfgang Kaczmarek**, Schwindegg
(DE)

(73) Assignee: **BSH Bosch und Siemens Hausgeraete GmbH**, Munich (DE)

(**) Term: **14 Years**

(21) Appl. No.: **29/360,741**

(22) Filed: **Apr. 30, 2010**

Related U.S. Application Data

(62) Division of application No. 29/310,830, filed on Sep. 10, 2009, now Pat. No. Des. 618,403.

(30) **Foreign Application Priority Data**

Mar. 12, 2008 (EM) 000904644

(51) **LOC (9) Cl.** **15-05**

(52) **U.S. Cl.** **D32/3**

(58) **Field of Classification Search** D32/1,
D32/2, 3, 28; D7/340, 348, 349, 350, 351,
D7/405; 134/56 D, 57 D, 58 D, 58 DL, 113,
134/201; 68/212; 312/31

See application file for complete search history.

(56) **References Cited**

U.S. PATENT DOCUMENTS

- D511,403 S * 11/2005 Ott et al. D32/3
- D511,870 S * 11/2005 Paik D32/2
- D513,548 S * 1/2006 Jeong D32/2
- D515,255 S * 2/2006 Jeong D32/3
- D530,460 S * 10/2006 Knochner D32/3
- D539,992 S * 4/2007 Yamamoto et al. D32/2

- D543,321 S * 5/2007 Jeon et al. D32/2
- D559,478 S * 1/2008 Jung et al. D32/2
- D560,863 S * 1/2008 Baldwin D32/3
- D571,064 S * 6/2008 Eicher et al. D32/28
- D573,762 S * 7/2008 Eicher et al. D32/28

* cited by examiner

Primary Examiner—T. Chase Nelson
Assistant Examiner—Kathleen M Sims

(74) *Attorney, Agent, or Firm*—James E. Howard; Andre Pallapies

(57) **CLAIM**

The ornamental design for a display for a dishwasher, as shown and described.

DESCRIPTION

FIG. 1 is a perspective view of a first embodiment of a display for a dishwasher showing my new ornamental design;

FIG. 2 is a front view thereof;

FIG. 3 is a perspective view of a second embodiment of a display for a dishwasher showing my new ornamental design;

FIG. 4 is a front view thereof;

FIG. 5 is a perspective view of a third embodiment of a display for a dishwasher showing my new ornamental design; and,

FIG. 6 is a front view thereof.

The rear and bottom views of the displays are not shown and do not form a part of the claimed design.

The broken lines represent environmental structure of the display for a dishwasher and do not form a part of the claimed design.

1 Claim, 6 Drawing Sheets

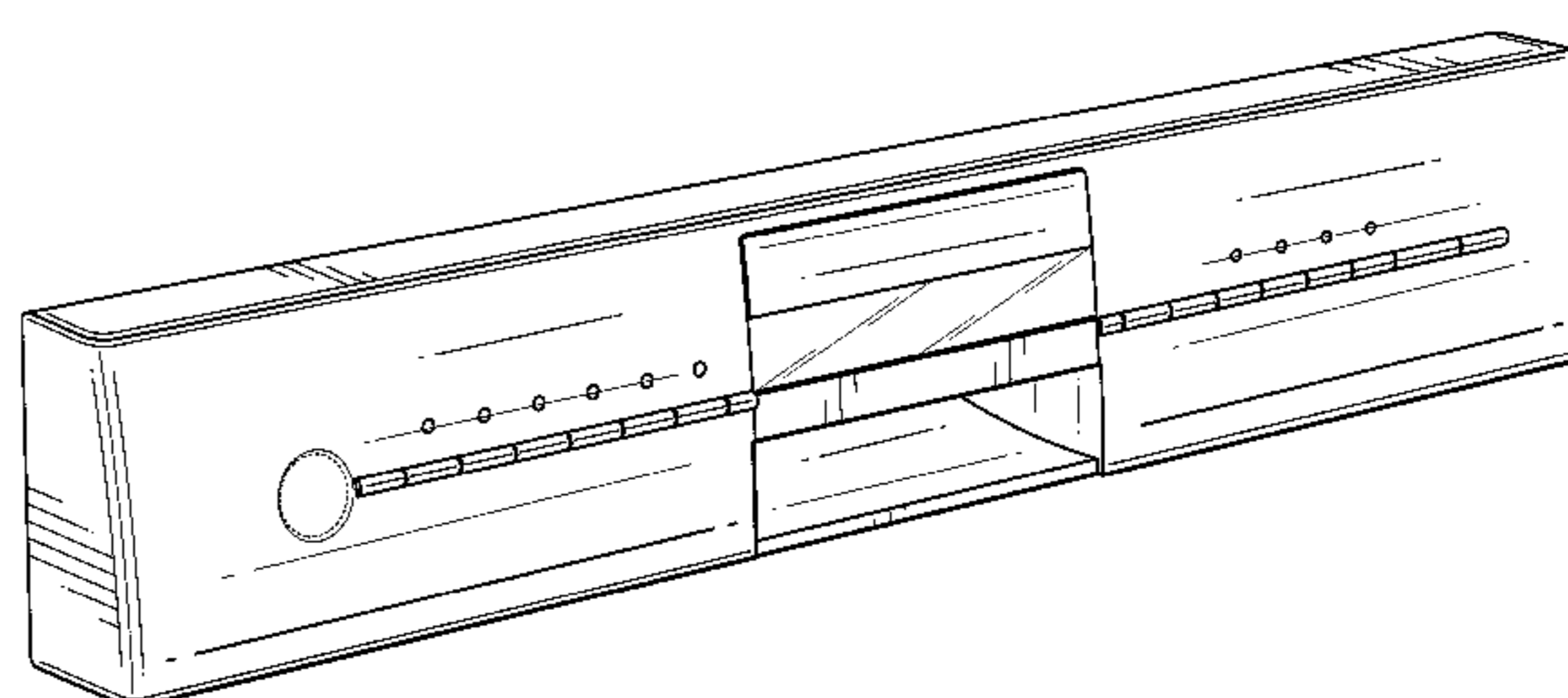
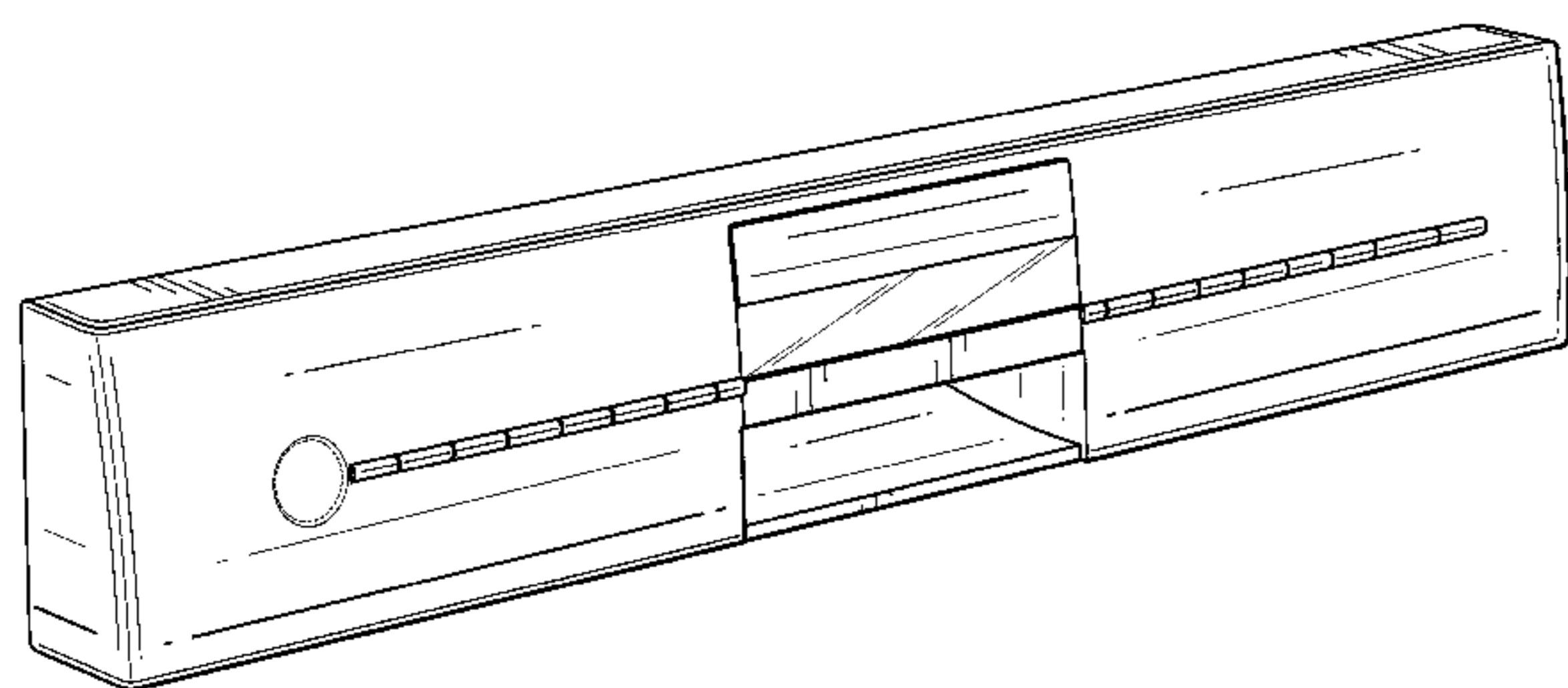

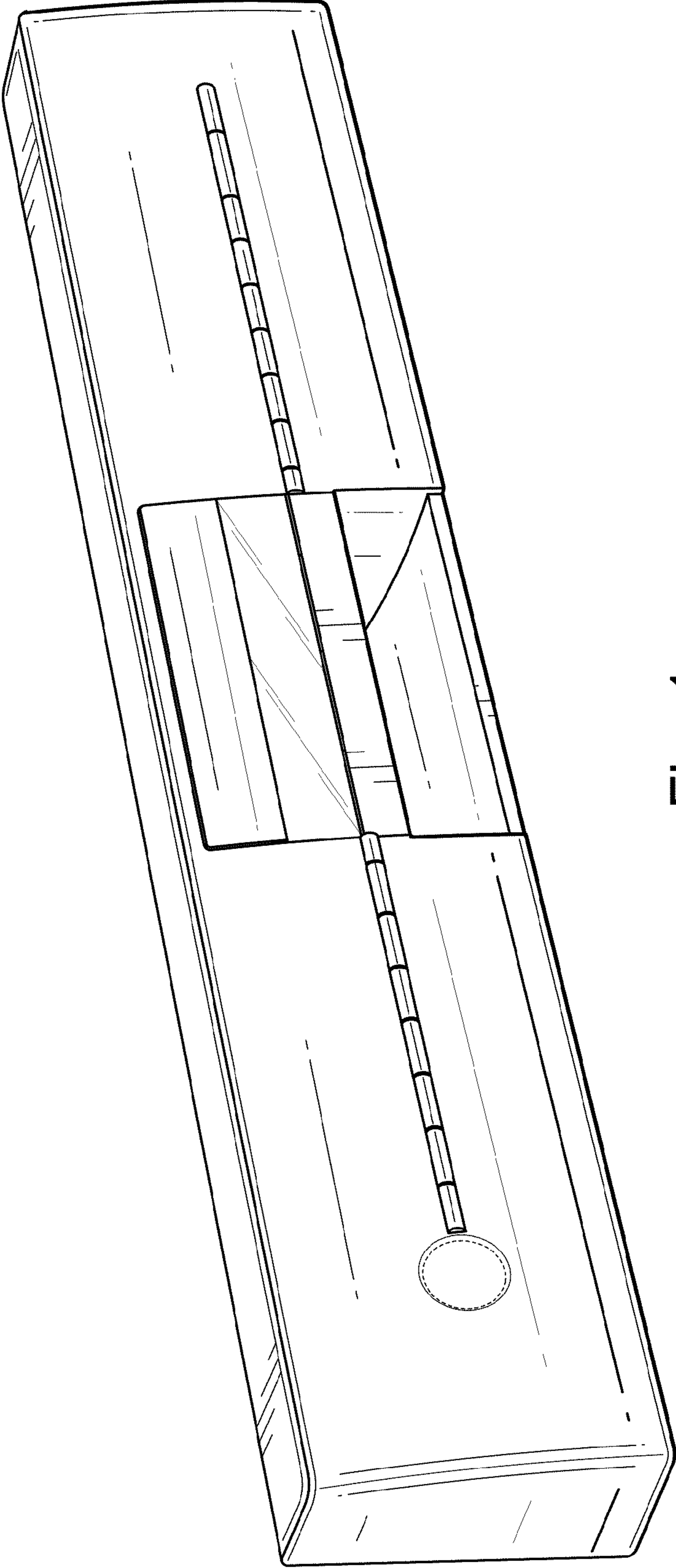

Fig. 1

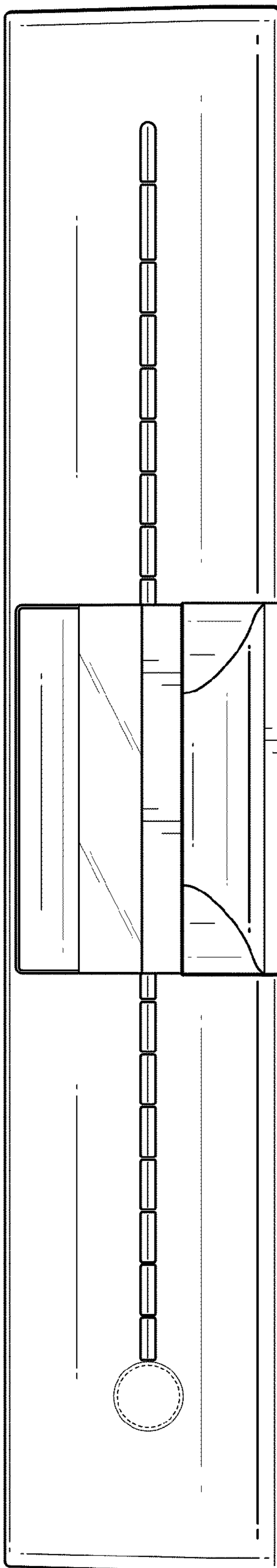

Fig. 2

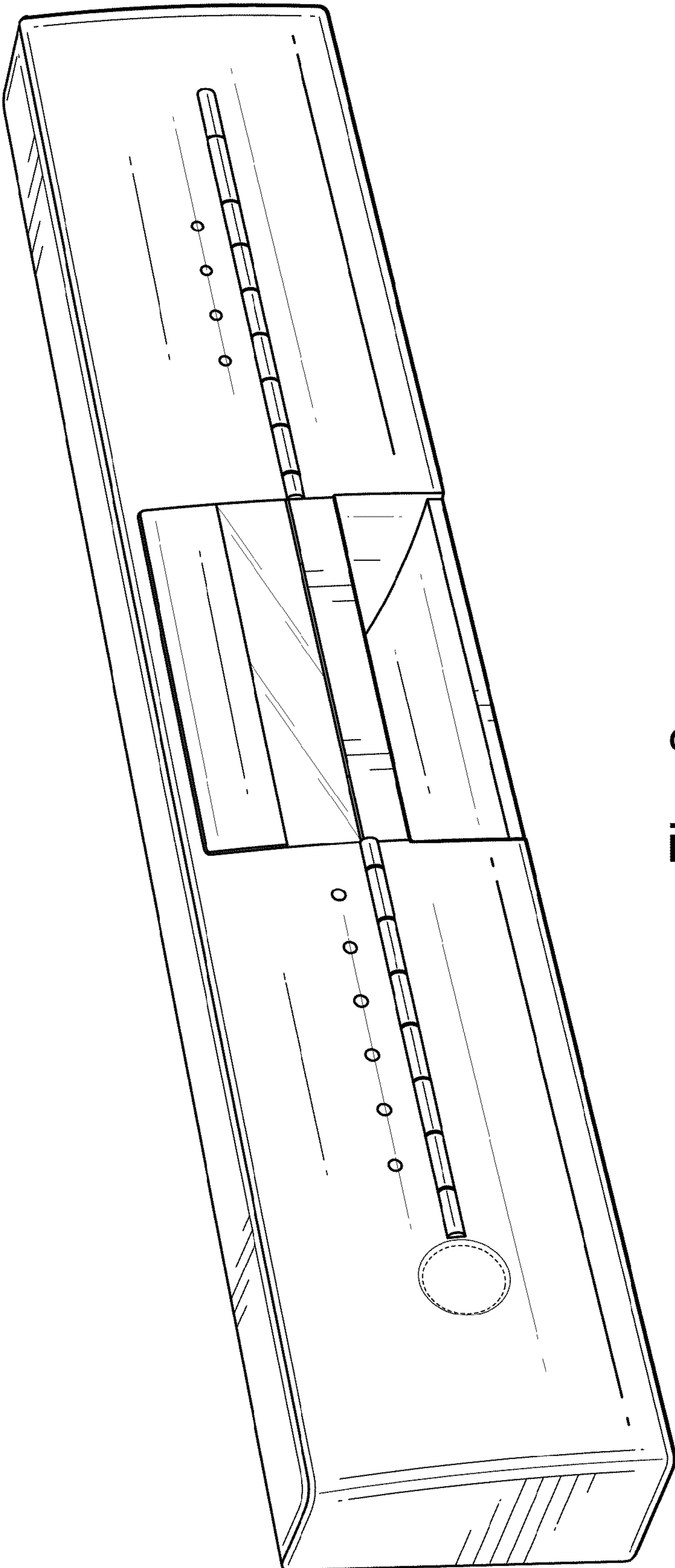

Fig. 3

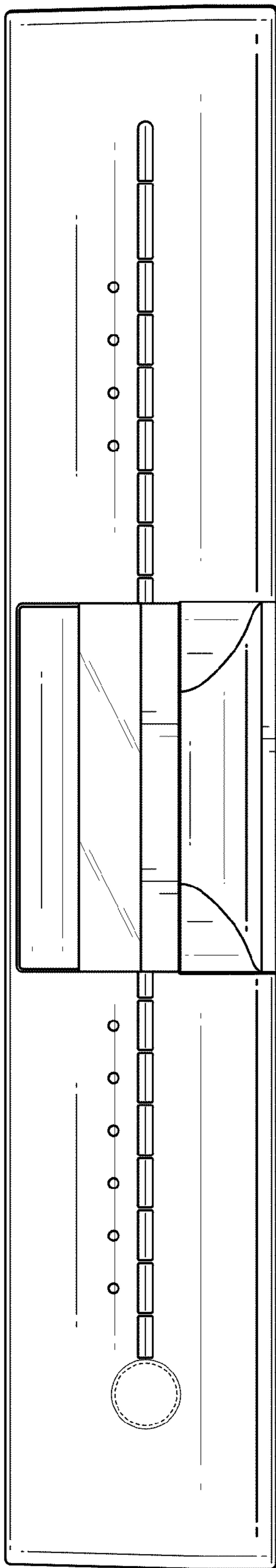

Fig. 4

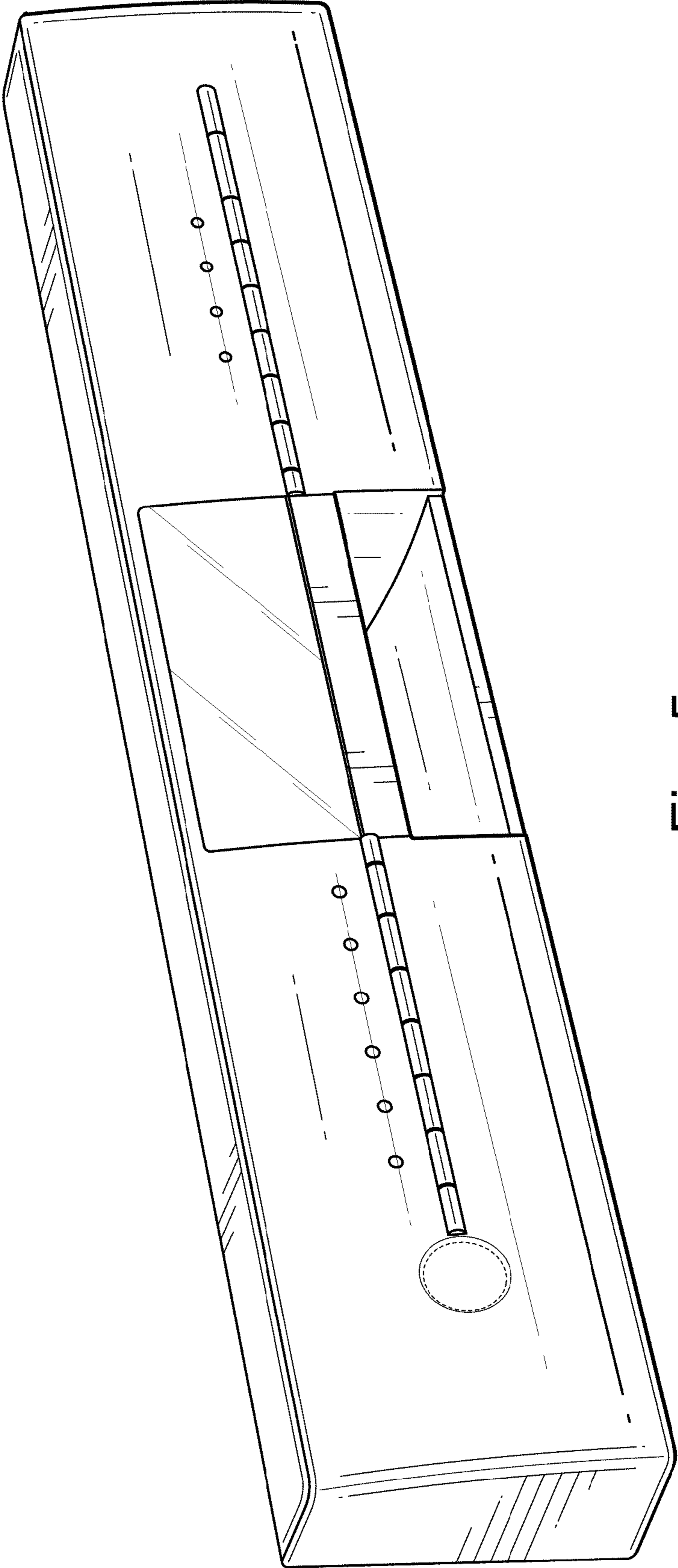

Fig. 5

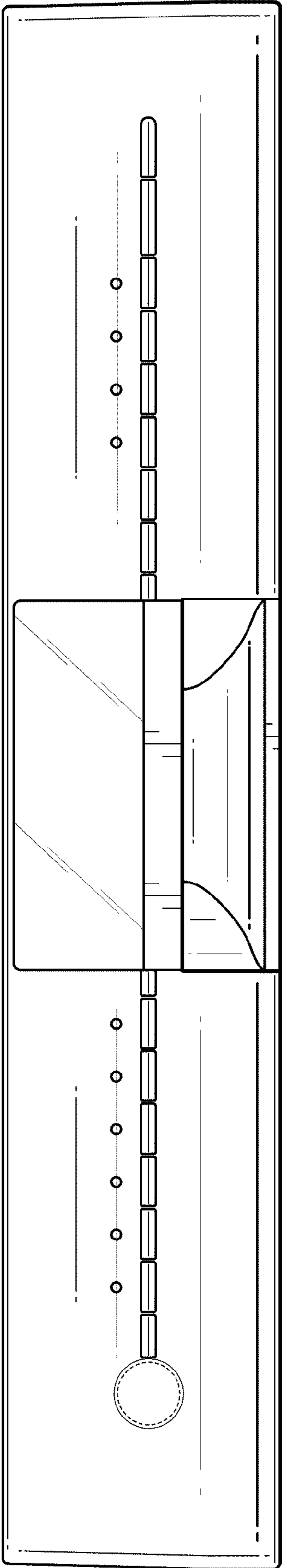

Fig. 6