



US00D630735S

(12) **United States Design Patent**  
**Behrbohm**

(10) **Patent No.:** **US D630,735 S**  
(45) **Date of Patent:** **\*\* Jan. 11, 2011**

(54) **MEDICAL DEVICE**

(75) Inventor: **Hans Behrbohm**, Berlin (DE)

(73) Assignee: **Karl Storz GmbH & Co. KG**,  
Tuttlingen (DE)

(\*\*) Term: **14 Years**

(21) Appl. No.: **29/358,543**

(22) Filed: **Mar. 29, 2010**

(30) **Foreign Application Priority Data**

Sep. 29, 2009 (EM) ..... 001617259-0004

(51) **LOC (9) Cl.** ..... **24-02**

(52) **U.S. Cl.** ..... **D24/133**

(58) **Field of Classification Search** ..... D24/133,  
D24/112, 146, 147; 600/139, 143-146, 156,  
600/159; 606/49, 127

See application file for complete search history.

(56) **References Cited**

**U.S. PATENT DOCUMENTS**

2,955,592	A *	10/1960	MacLean	.....	600/569
3,253,590	A *	5/1966	Birnberg et al.	.....	128/840
D237,116	S *	10/1975	Ekbladh	.....	D24/147
D241,476	S *	9/1976	Lahay	.....	D24/112
4,049,000	A *	9/1977	Williams	.....	604/119
D247,915	S *	5/1978	Lahay	.....	D24/112
D340,111	S *	10/1993	Yoshikawa	.....	D24/112
6,475,142	B1 *	11/2002	Parsons et al.	.....	600/232
D469,871	S *	2/2003	Sand	.....	D24/133
D582,552	S *	12/2008	Berberich	.....	D24/146
2004/0181237	A1 *	9/2004	Forde et al.	.....	606/108
2005/0234298	A1 *	10/2005	Kucklick et al.	.....	600/156

2006/0229496 A1\* 10/2006 Windheuser et al. .... 600/117

\* cited by examiner

*Primary Examiner*—Bridget L Eland

(74) *Attorney, Agent, or Firm*—Muncy, Geissler, Olds &  
Lowe, PLLC

(57) **CLAIM**

The ornamental design for a medical device, as shown and described.

**DESCRIPTION**

FIG. 1 is a left side perspective view of a medical device of the present invention.

FIG. 2 is a right side perspective view of the medical device of FIG. 1.

FIG. 3 is a top perspective view of the medical device of FIG. 1.

FIG. 4 is a bottom perspective view of the medical device of FIG. 1.

FIG. 5 is a front perspective view of the medical device of FIG. 1.

FIG. 6 is a bottom perspective view of the medical device of FIG. 1; and,

FIG. 7 is a three-quarter perspective view of the medical device of FIG. 1.

The broken lines immediately adjacent the claimed areas represent the bounds of the claimed design while all other broken lines are directed to environment and are for illustrative purposes only; the broken lines form no part of the claimed design.

**1 Claim, 7 Drawing Sheets**

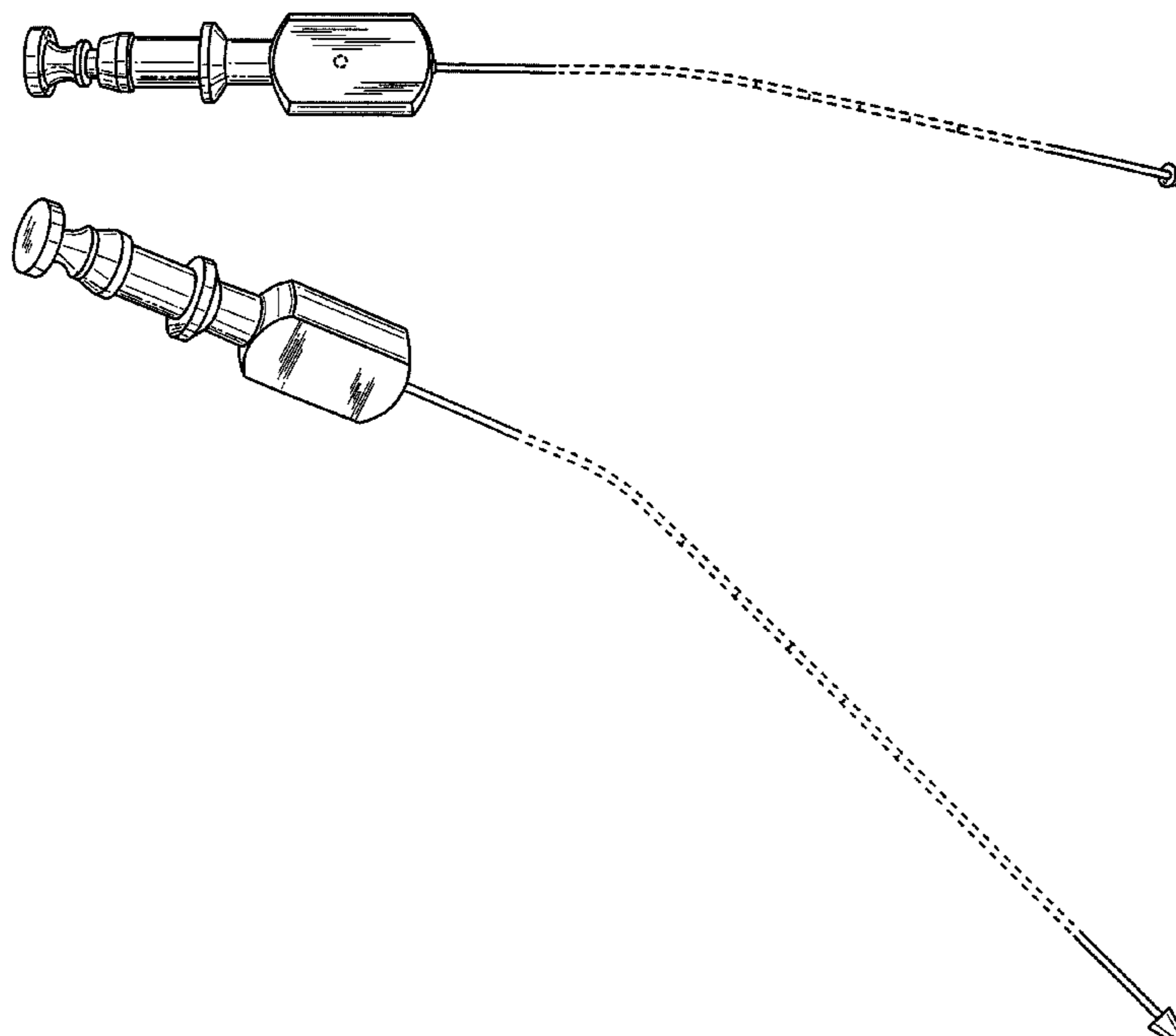

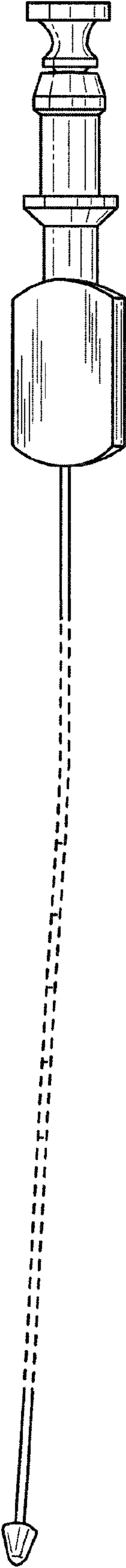

**FIG. 1**

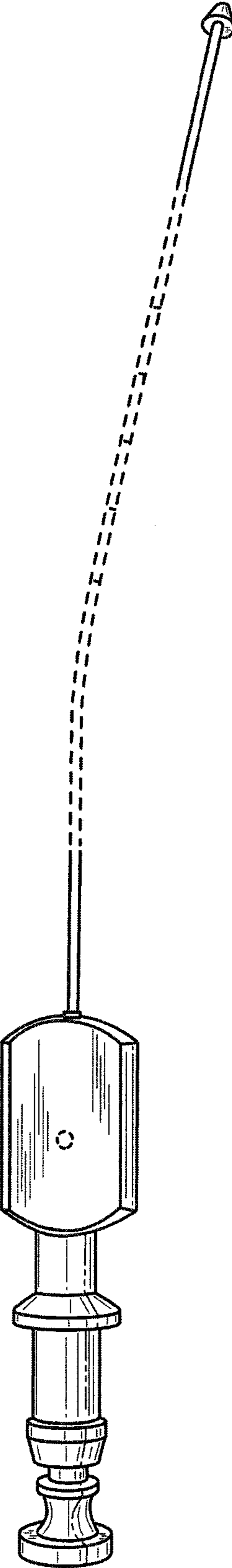
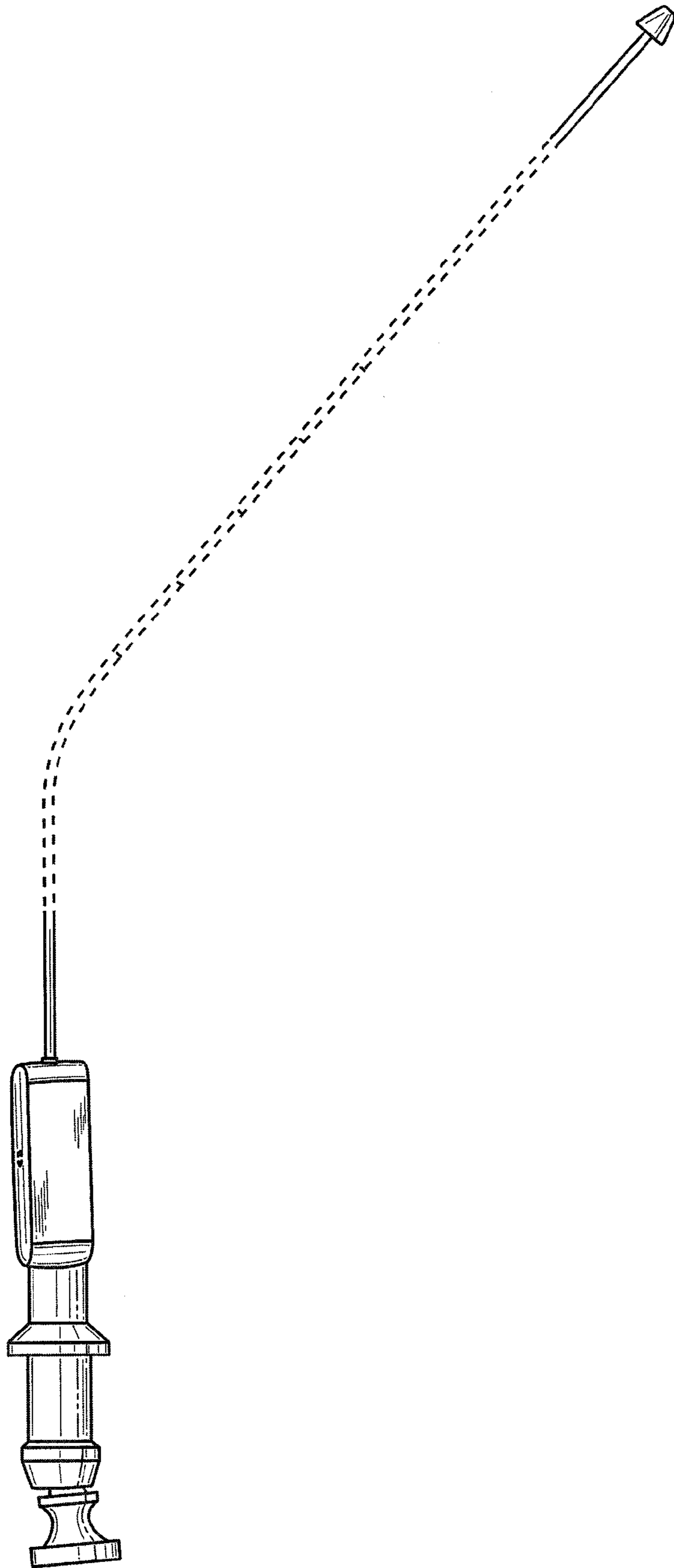
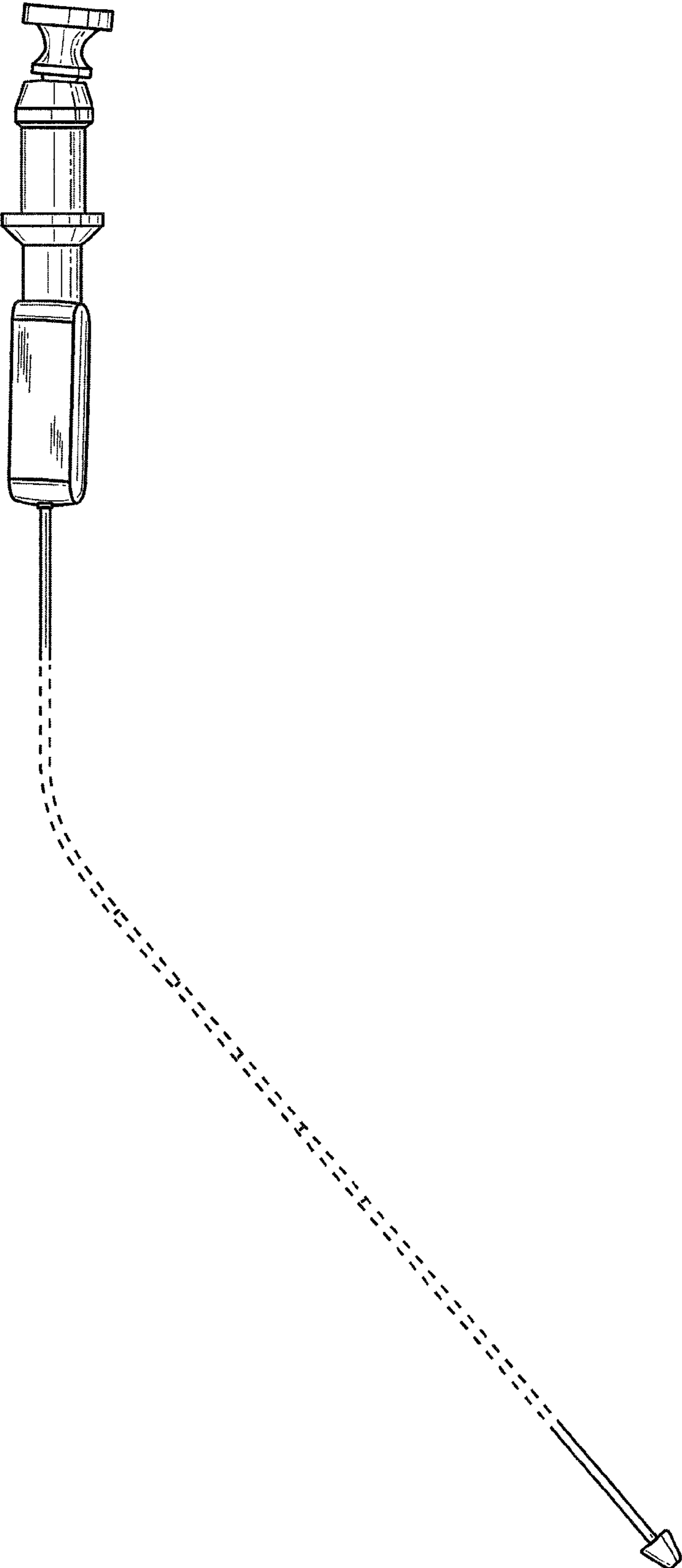

FIG. 2



**FIG. 3**



**FIG. 4**

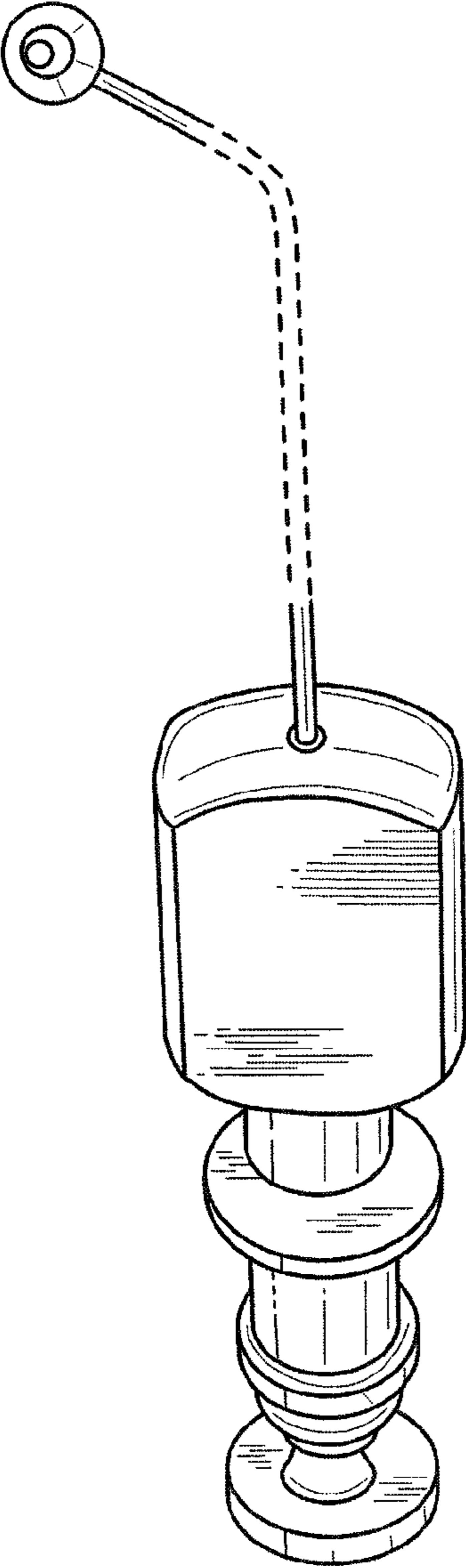

**FIG. 5**

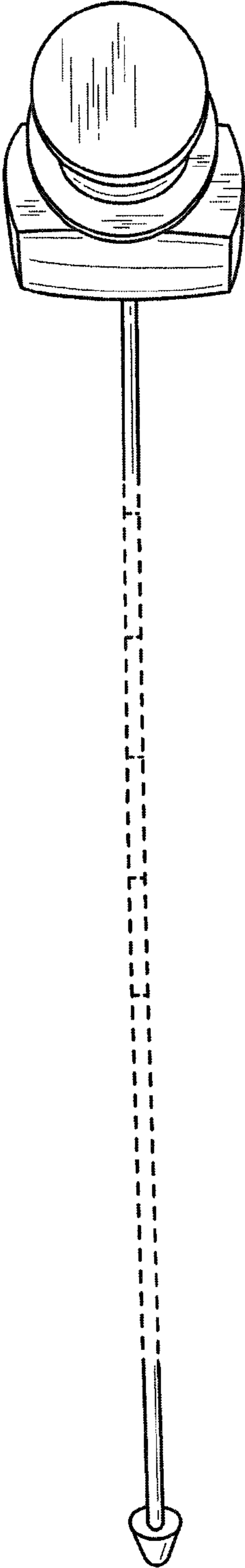

**FIG. 6**

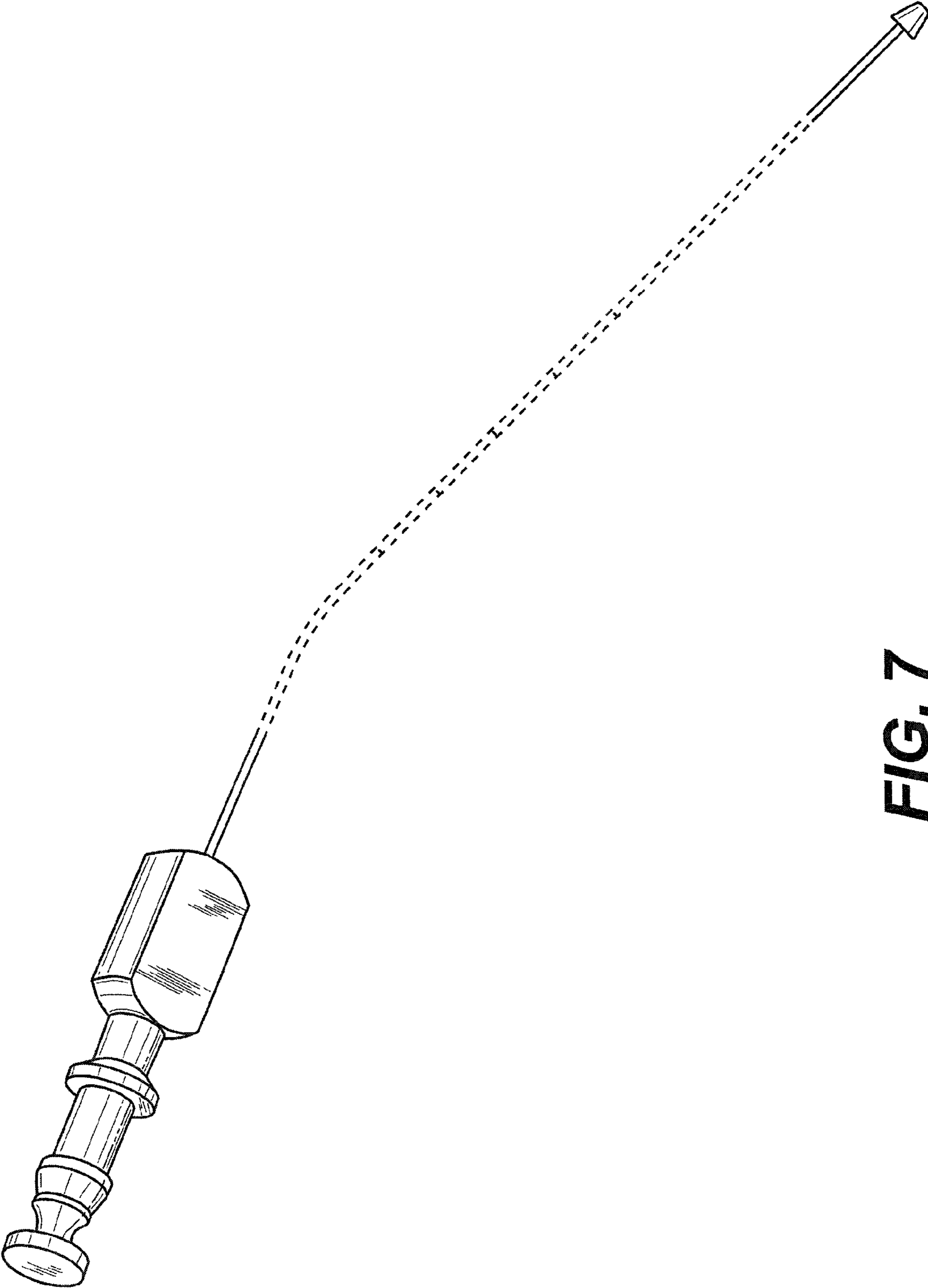

**FIG. 7**