

US00D630683S

(12) **United States Design Patent**
Vrotsos

(10) **Patent No.:** **US D630,683 S**

(45) **Date of Patent:** **** Jan. 11, 2011**

(54) **DESKTOP ORGANIZER**

(75) Inventor: **Linda Vrotsos**, Madison, WI (US)

(73) Assignee: **Learning Loft, Inc.**, Madison, WI (US)

(**) Term: **14 Years**

(21) Appl. No.: **29/345,675**

(22) Filed: **Oct. 20, 2009**

(51) **LOC (9) Cl.** **19-02**

(52) **U.S. Cl.** **D19/78**

(58) **Field of Classification Search** D6/449,
D6/512; D19/75-83, 86-92, 95-100; D21/392;
206/214, 215, 425, 555; 248/473; 273/148 A,
273/150
See application file for complete search history.

(56) **References Cited**

U.S. PATENT DOCUMENTS

1,479,350	A *	1/1924	Wiel	273/150
1,506,088	A *	8/1924	Sanchez	273/150
1,557,774	A *	10/1925	Pool et al.	273/150
1,588,618	A *	6/1926	Rosen	273/150
1,629,070	A *	5/1927	Cox	273/150
2,598,890	A *	6/1952	Cisi et al.	40/618
D253,119	S *	10/1979	Lamont	D19/90
D262,727	S *	1/1982	Snyder	D21/392
D265,211	S *	6/1982	Knight	D19/35
D325,600	S *	4/1992	Schmidt	D19/65

D337,618	S *	7/1993	Chan	D19/92
D347,451	S *	5/1994	Kazakowitz	D21/392
D349,925	S *	8/1994	Charron et al.	D19/90
D358,066	S *	5/1995	Blackwood	D6/449
D372,742	S *	8/1996	Kakudo	D21/392
D383,122	S *	9/1997	Parks	D14/455
D392,680	S *	3/1998	Shaefer	D19/90
D393,045	S *	3/1998	Hsu	D20/43
6,782,629	B2 *	8/2004	Jimenez et al.	33/483
D522,273	S *	6/2006	Benson	D6/470
D597,604	S *	8/2009	E	D19/91

* cited by examiner

Primary Examiner—Elizabeth A Albert

(74) *Attorney, Agent, or Firm*—Casimir Jones S.C.

(57) **CLAIM**

The ornamental design for a desktop organizer, as shown and described.

DESCRIPTION

FIG. 1 is a top perspective view showing my new design;
FIG. 2 is a front elevational view thereof;
FIG. 3 is a rear elevational view thereof;
FIG. 4 is a left side elevational view thereof;
FIG. 5 is a right side elevational view thereof;
FIG. 6 is a top plan view thereof; and,
FIG. 7 is a bottom plan view thereof.

1 Claim, 5 Drawing Sheets

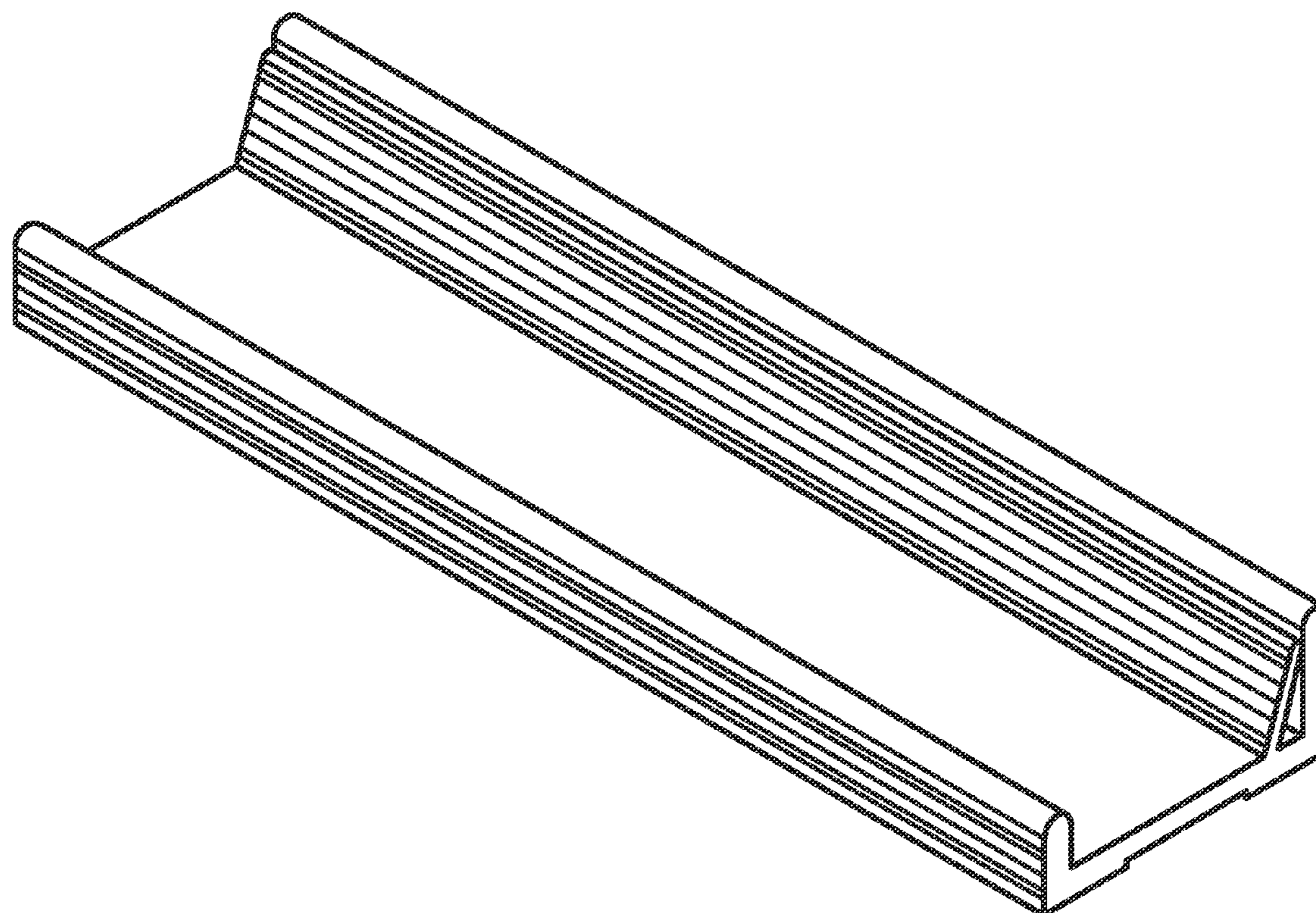

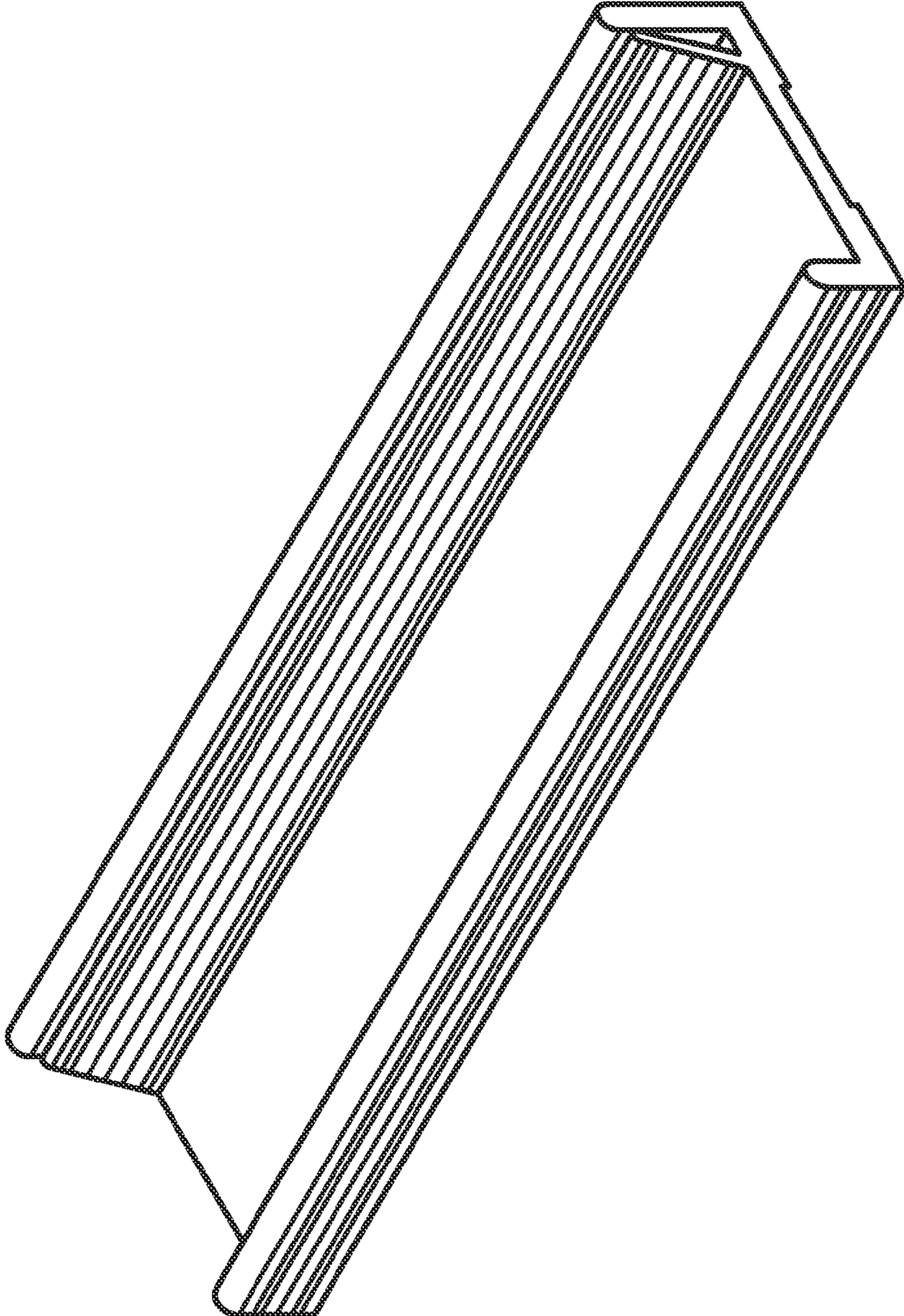

FIG. 1

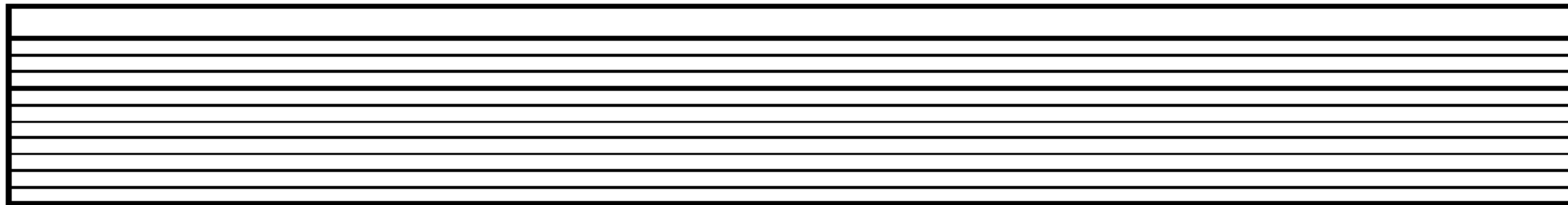

FIG. 2

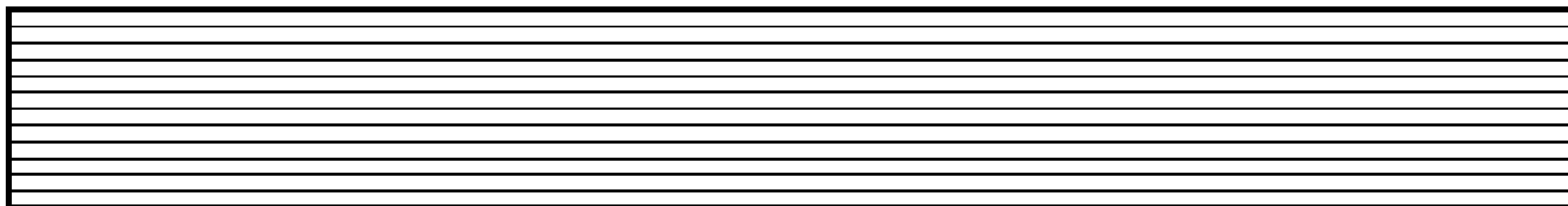

FIG. 3

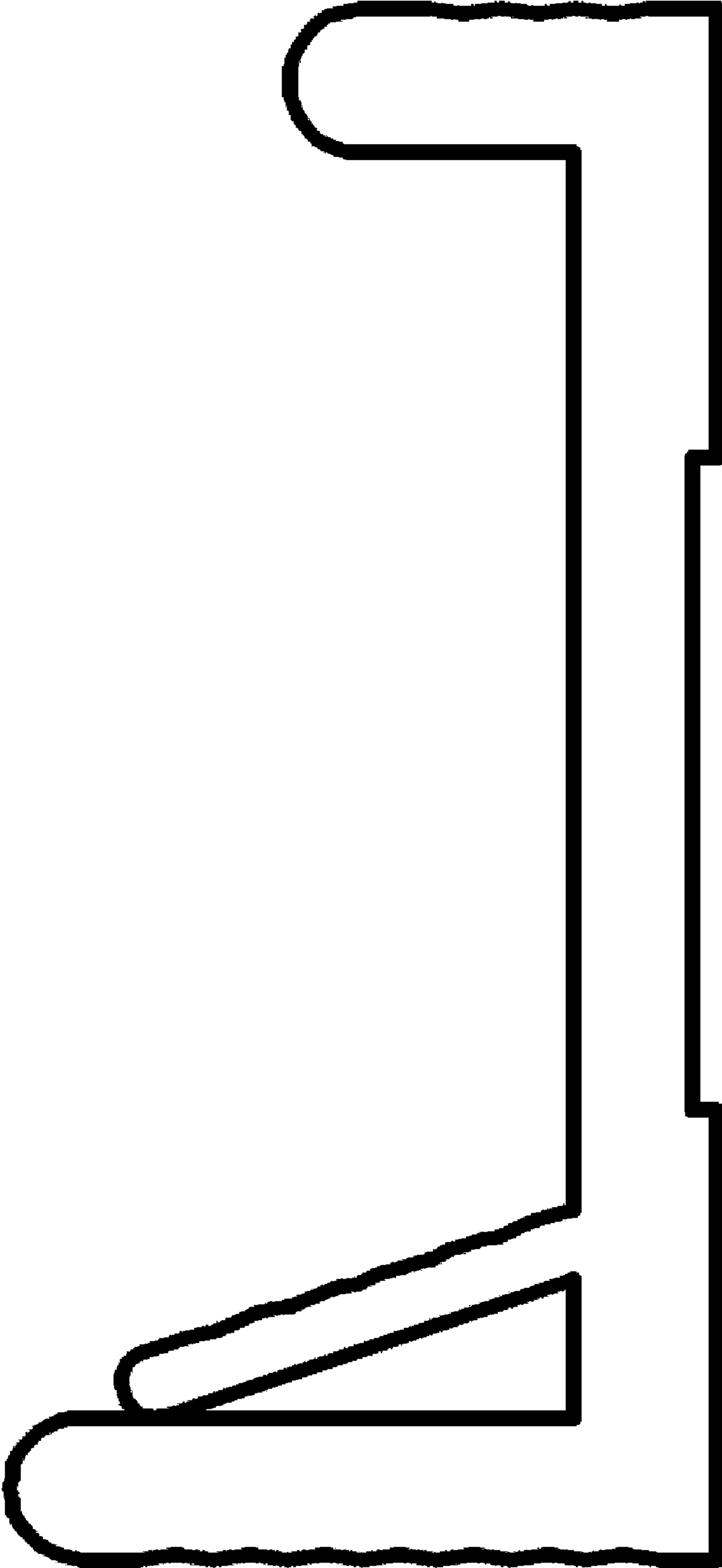

FIG. 4

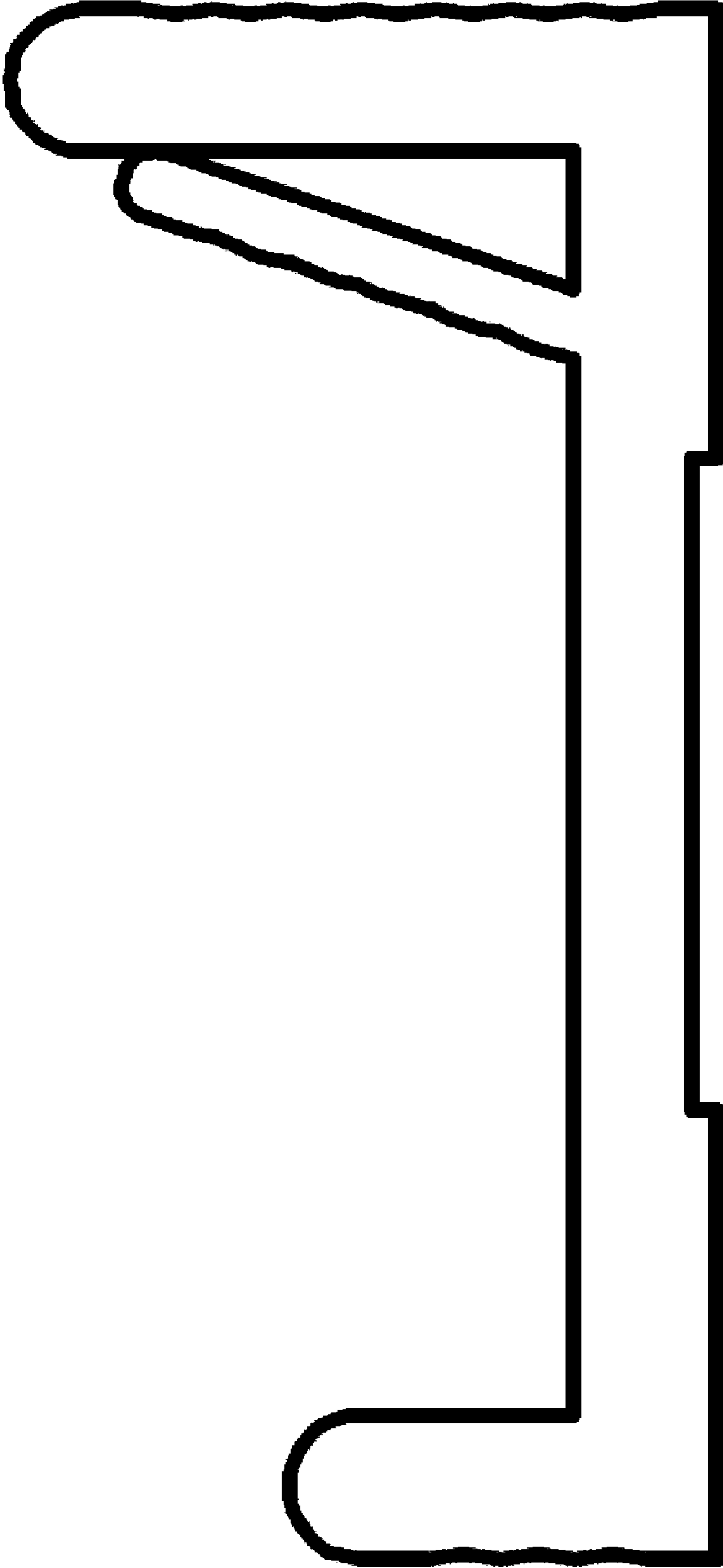

FIG. 5

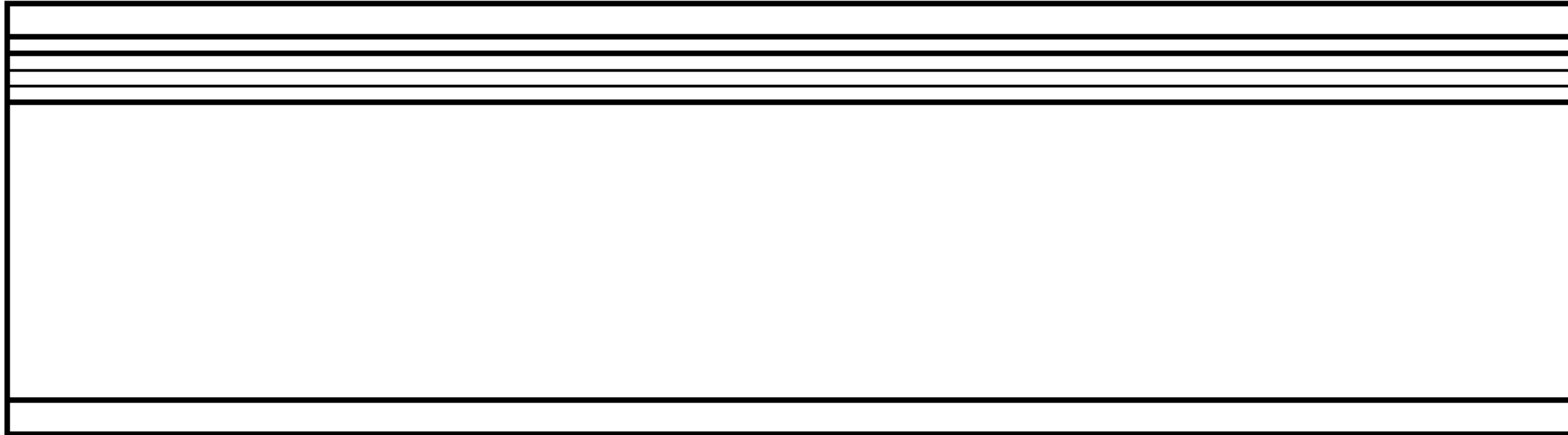

FIG. 6

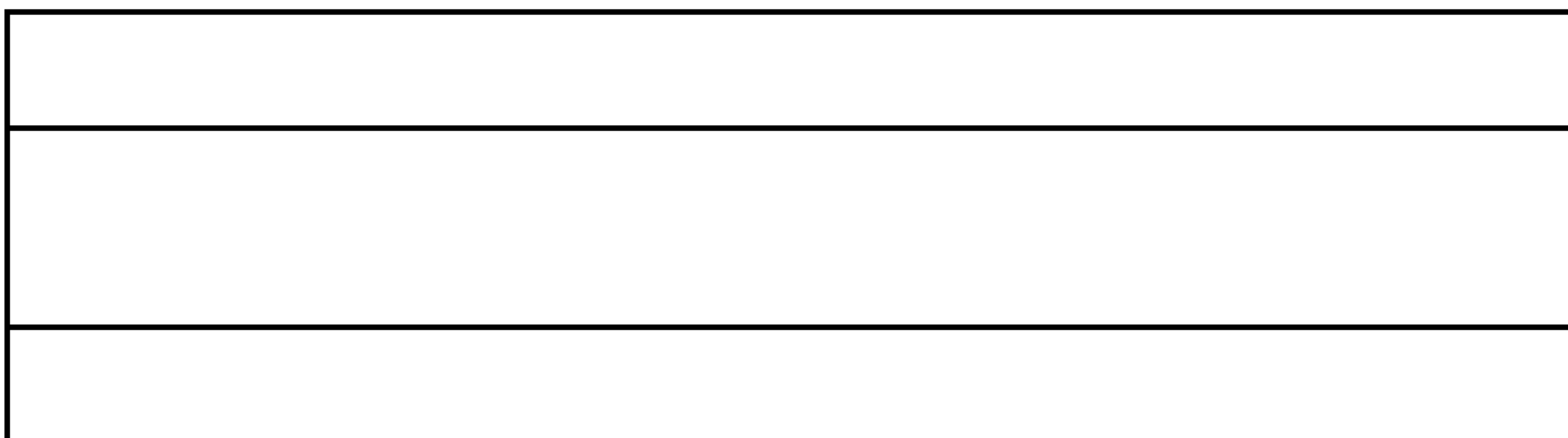

FIG. 7