



US00D630543S

(12) **United States Design Patent**
Humphries

(10) **Patent No.:** **US D630,543 S**

(45) **Date of Patent:** **** Jan. 11, 2011**

(54) **MAGNETIC JEWELRY CLASP**

(76) Inventor: **John Edward Faget Humphries**, 7813
Jeannette St., New Orleans, LA (US)
70118

(**) Term: **14 Years**

(21) Appl. No.: **29/363,321**

(22) Filed: **Jun. 8, 2010**

(51) **LOC (9) Cl.** **11-02**

(52) **U.S. Cl.** **D11/87**

(58) **Field of Classification Search** D11/200–231,
D11/87, 88, 3, 86; 24/196, 616, 625, 650,
24/114.6, 303, 658, 41.1; D8/382; 63/12,
63/18, 20, 3, 3.1, 3.2

See application file for complete search history.

(56) **References Cited**

U.S. PATENT DOCUMENTS

D87,434 S *	7/1932	Haas	D11/200
D165,080 S *	11/1951	Lennenberg	D11/87
2,615,227 A	10/1952	Hornik		
2,648,884 A	8/1953	Loofboro		
D170,403 S *	9/1953	De Saint Germain	D11/6
2,956,324 A	10/1960	Klein		
3,621,690 A	11/1971	Whitcomb		
3,974,545 A *	8/1976	Lossini	24/116 R
D264,828 S *	6/1982	Gray	D11/87
D307,730 S *	5/1990	Foster	D11/200
D325,546 S	4/1992	Collier		
5,664,298 A	9/1997	Nessar-Ivanovie		
5,701,640 A *	12/1997	Locher	24/303
6,591,462 B2 *	7/2003	Fuhrman	24/303
6,598,271 B2	7/2003	Nire		
6,640,398 B2	11/2003	Hoffman		
D500,459 S *	1/2005	Phlippeau	D11/200
D514,474 S *	2/2006	Neri	D11/200

7,152,282 B2	12/2006	Costa		
7,334,433 B1	2/2008	Fuhrman et al.		
D622,128 S *	8/2010	Laurenza	D11/87
2003/0229974 A1 *	12/2003	Zemer et al.	24/303

* cited by examiner

Primary Examiner—Cathron C Brooks

Assistant Examiner—Melanie Levy

(74) *Attorney, Agent, or Firm*—Amster Rothstein & Ebenstein, LLP

(57) **CLAIM**

The ornamental design for a magnetic jewelry clasp, as shown and described.

DESCRIPTION

FIG. 1 is a top, front perspective view with a portion of unclaimed environmental structure shown;

FIG. 2 is a bottom, front perspective view thereof;

FIG. 3 is a front view thereof;

FIG. 4 is a top, front perspective view thereof, but in a closed position;

FIG. 5 is a side view thereof, shown without the unclaimed structure;

FIG. 6 is the opposite side view of the clasp of FIG. 5;

FIG. 7 is a front view of the clasp of FIG. 5;

FIG. 8 is a rear view of the clasp of FIG. 5;

FIG. 9 is a top view of the clasp of FIG. 5; and,

FIG. 10 is a bottom view of the clasp of FIG. 5.

The broken lines shown in the drawings represent environmental structure and unclaimed portions of the design and form no part thereof.

1 Claim, 5 Drawing Sheets

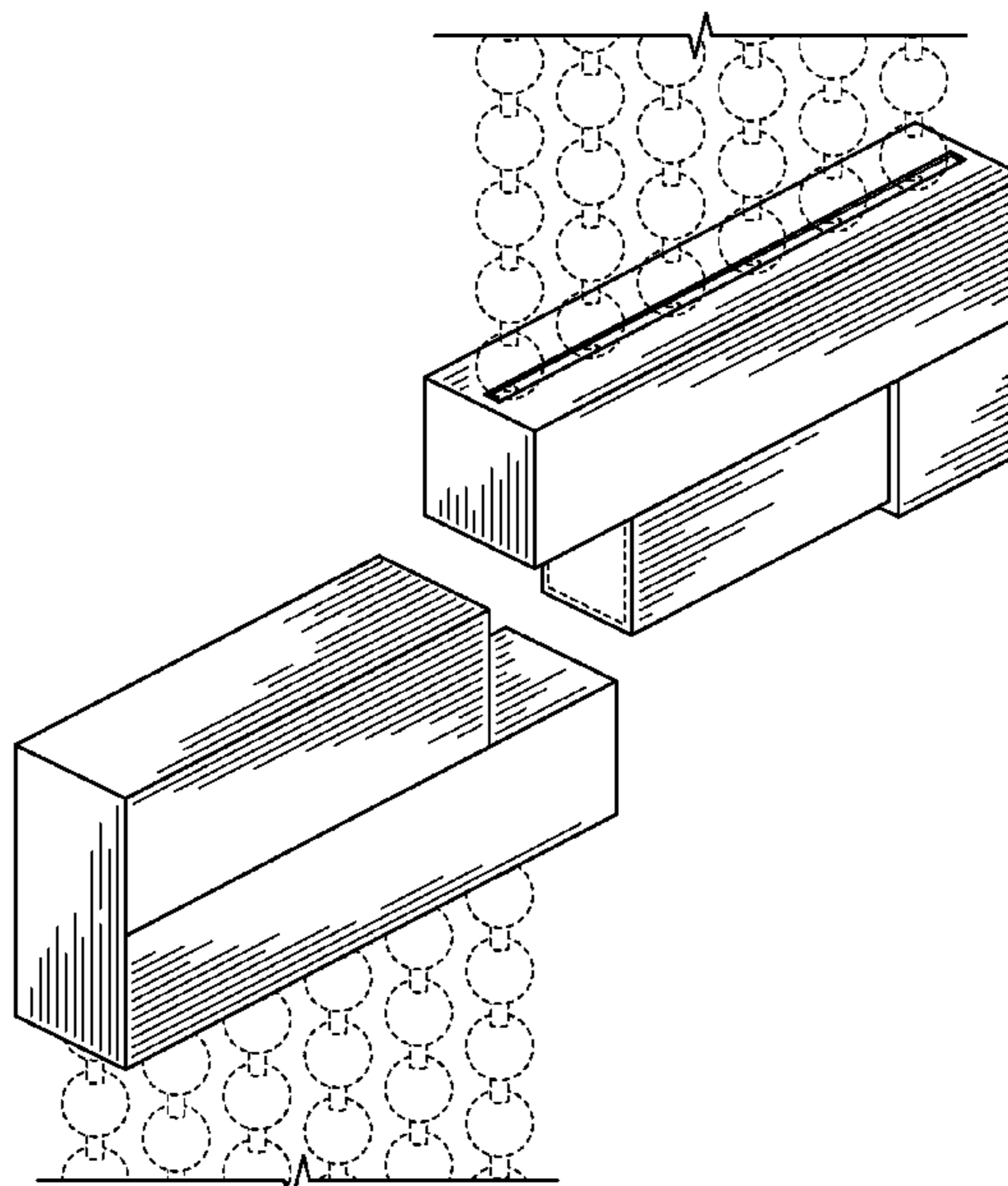

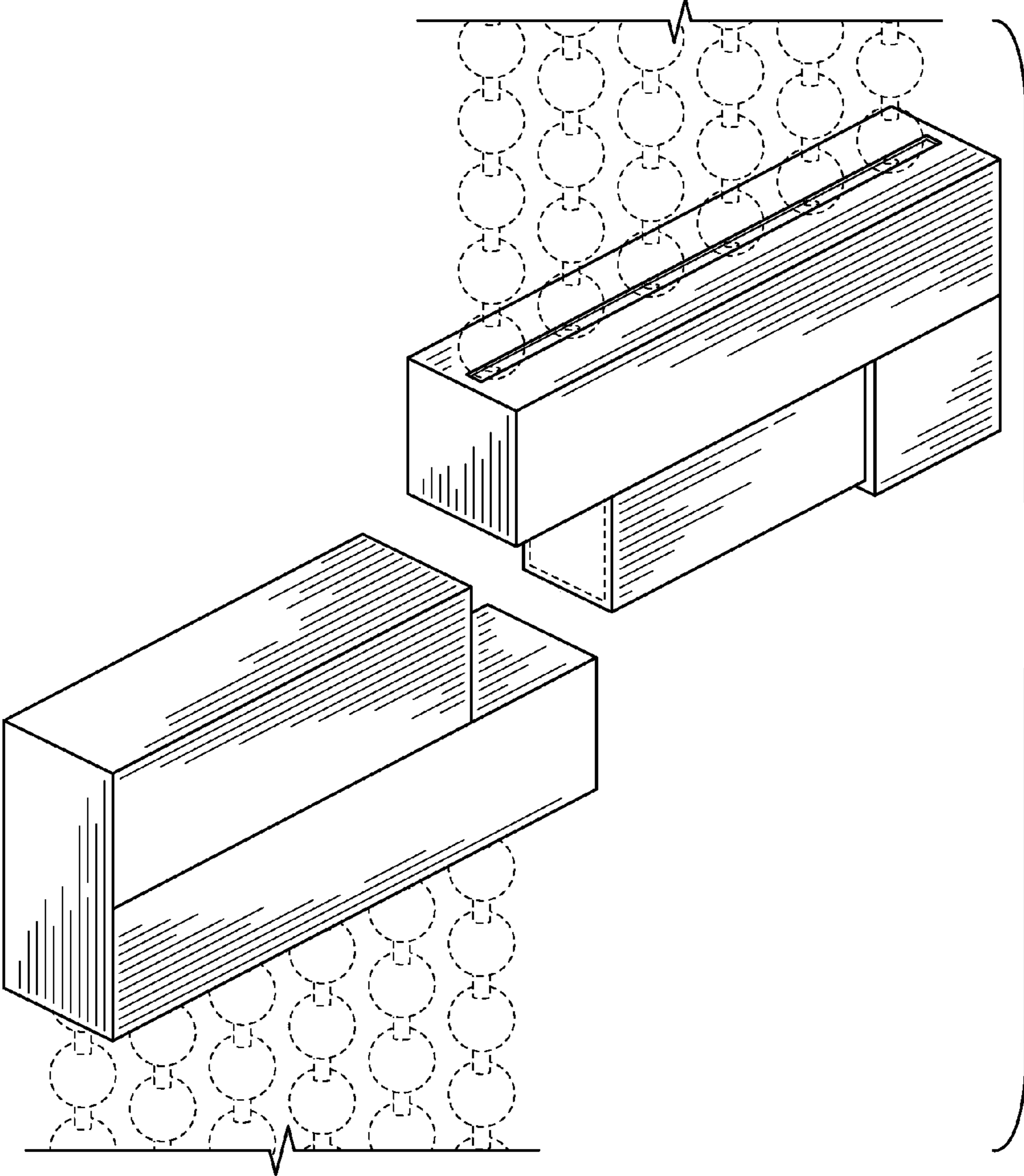

FIG. 1

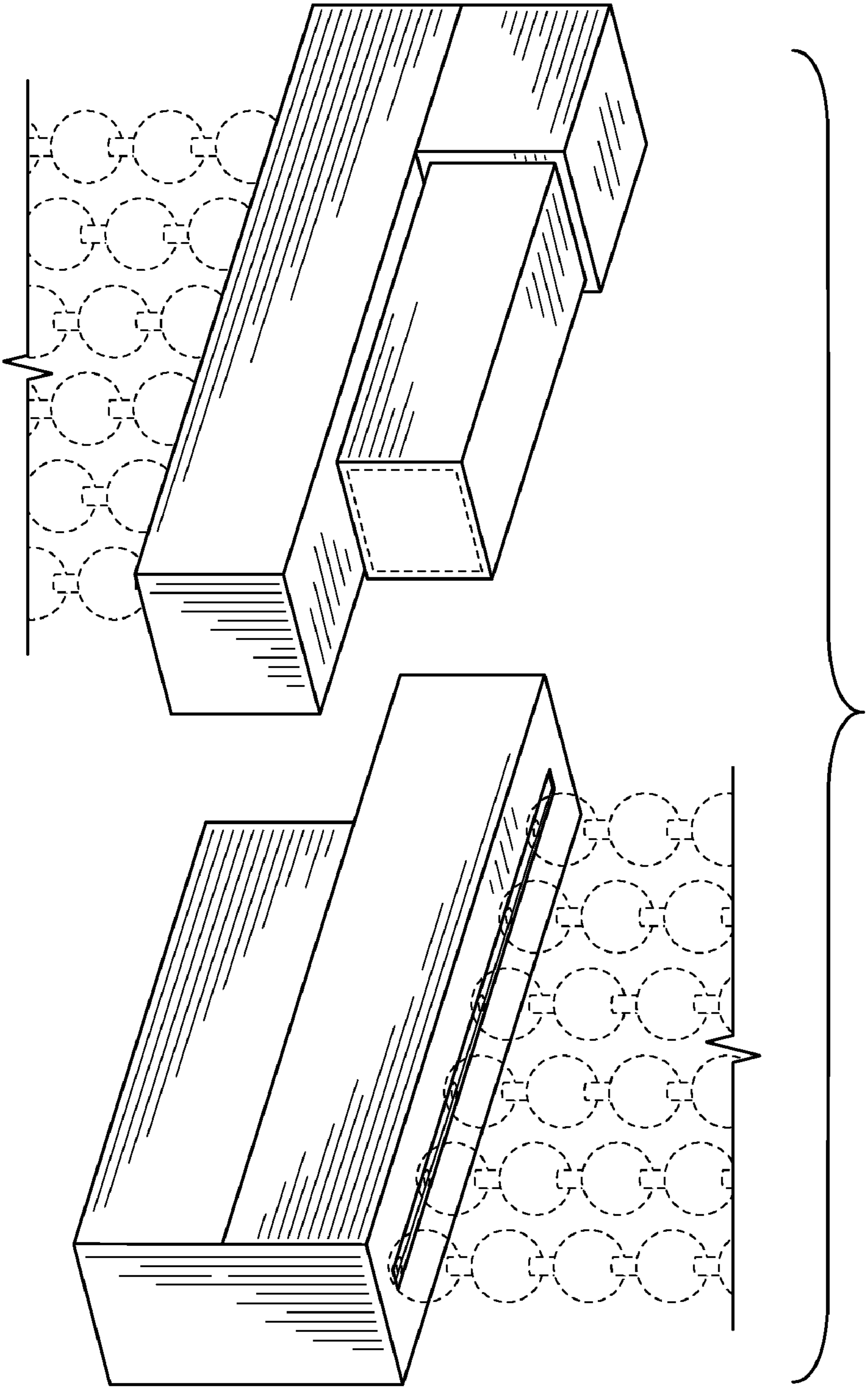
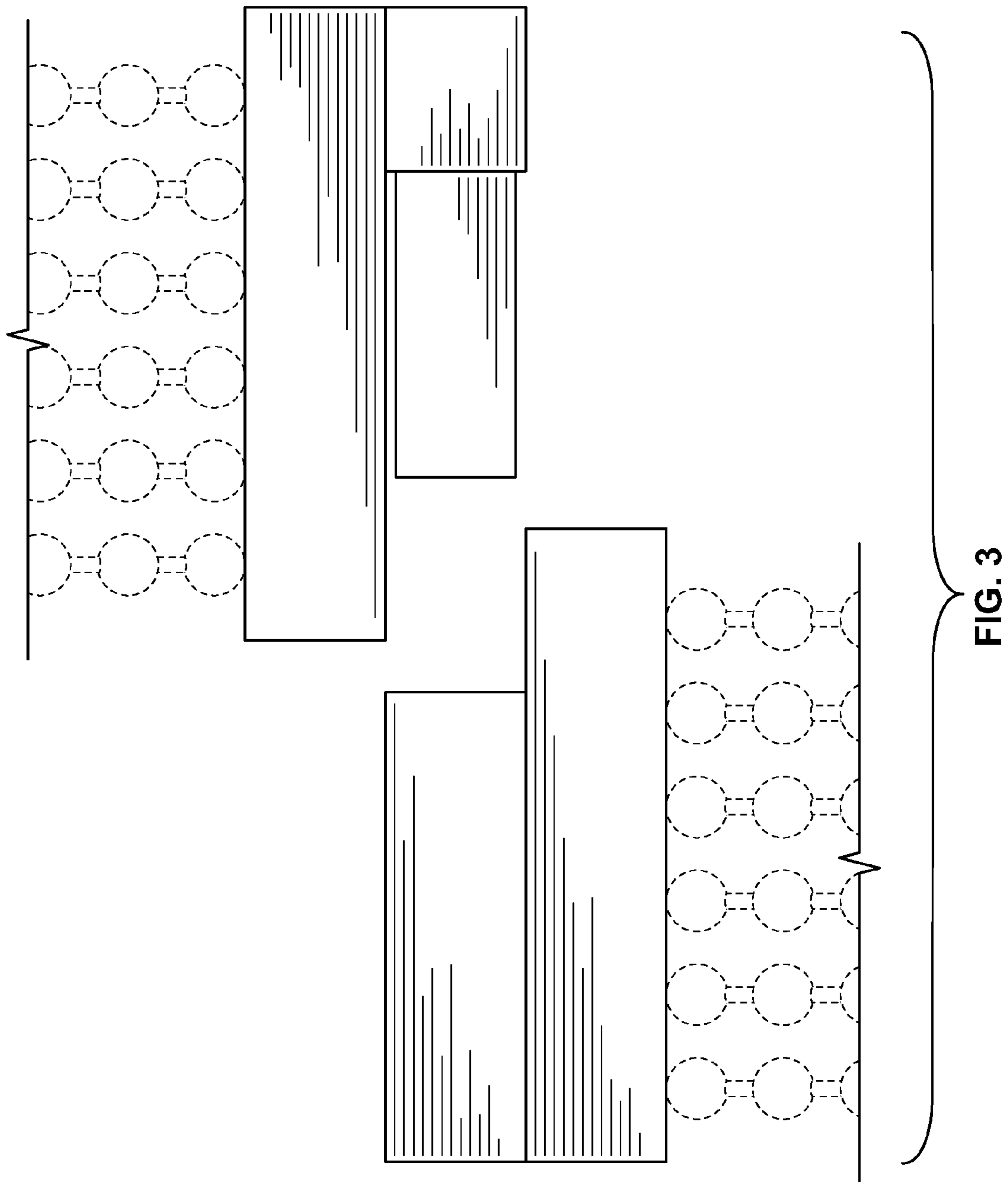

FIG. 2



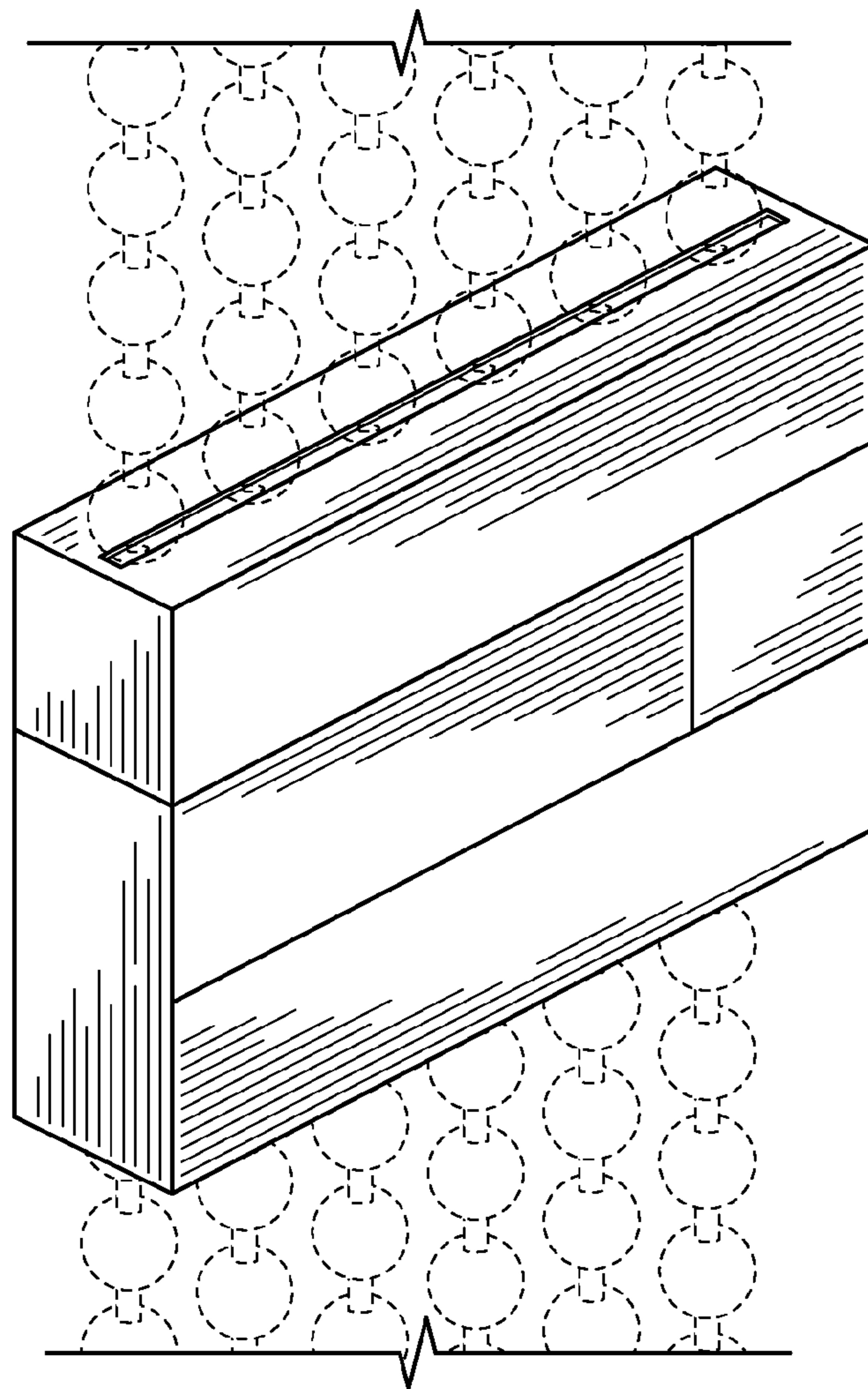

FIG. 4

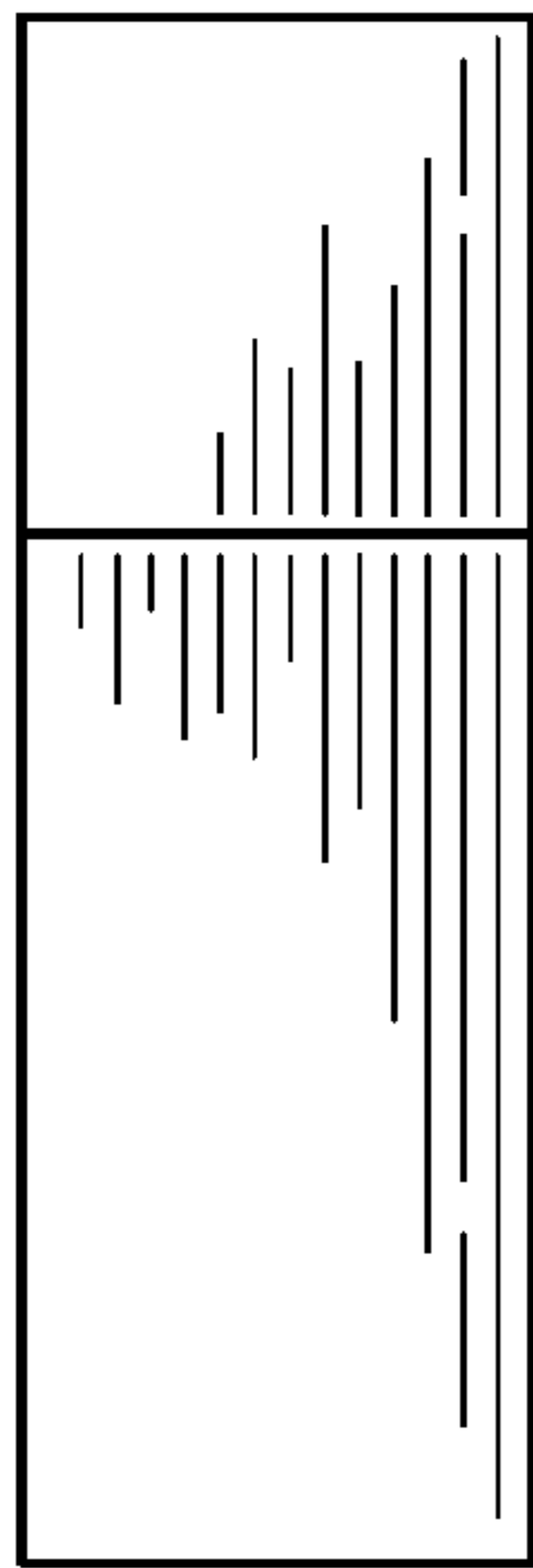

FIG. 5

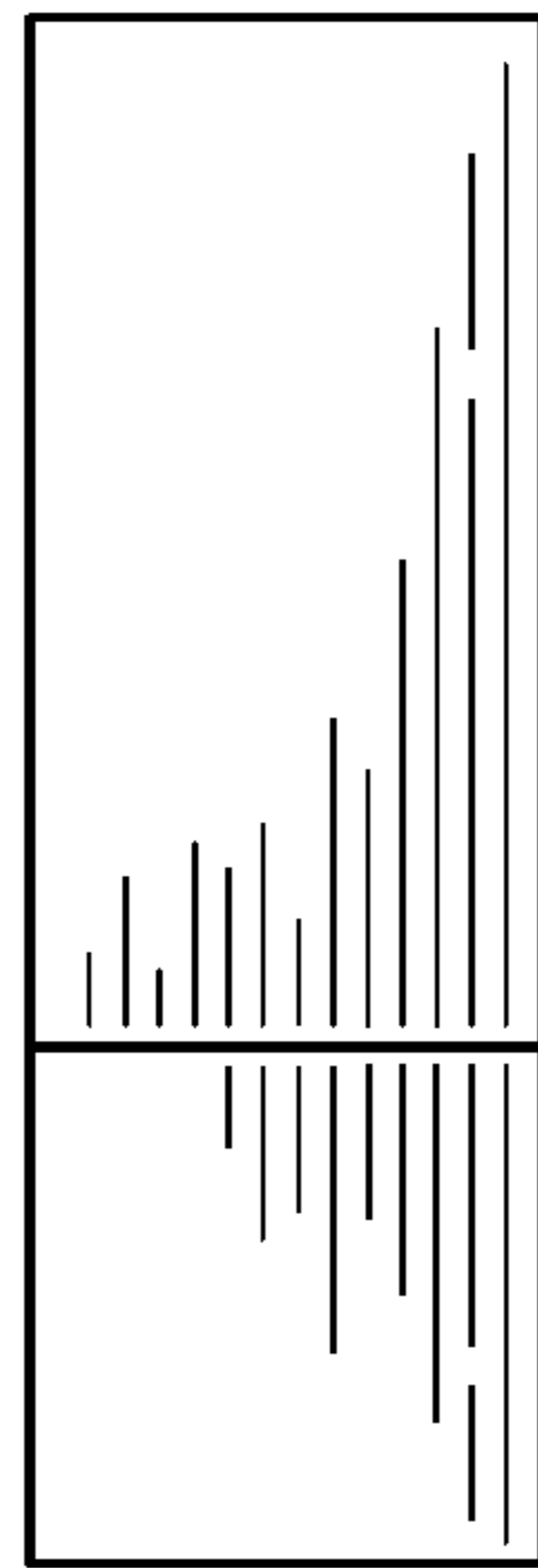

FIG. 6

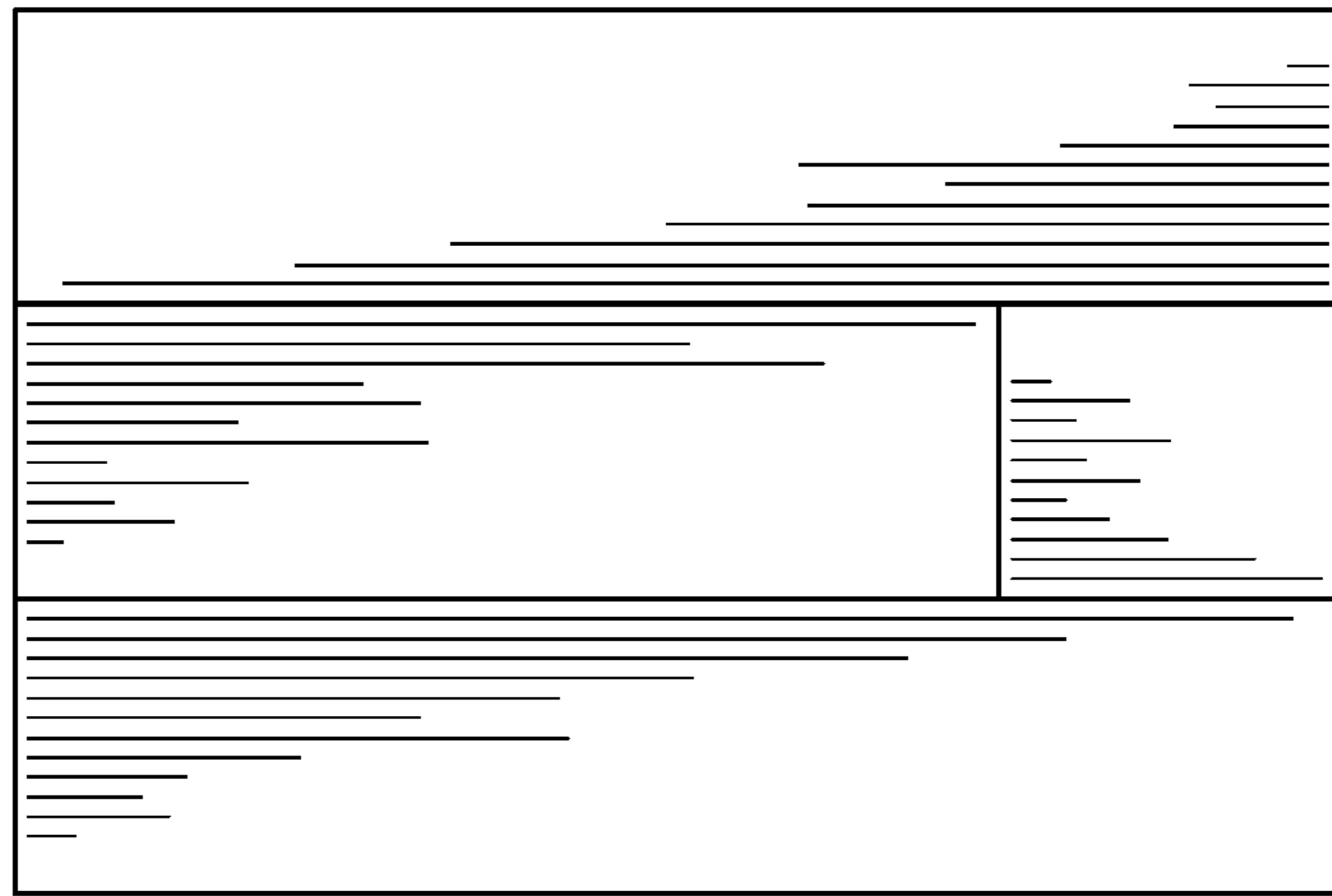

FIG. 7

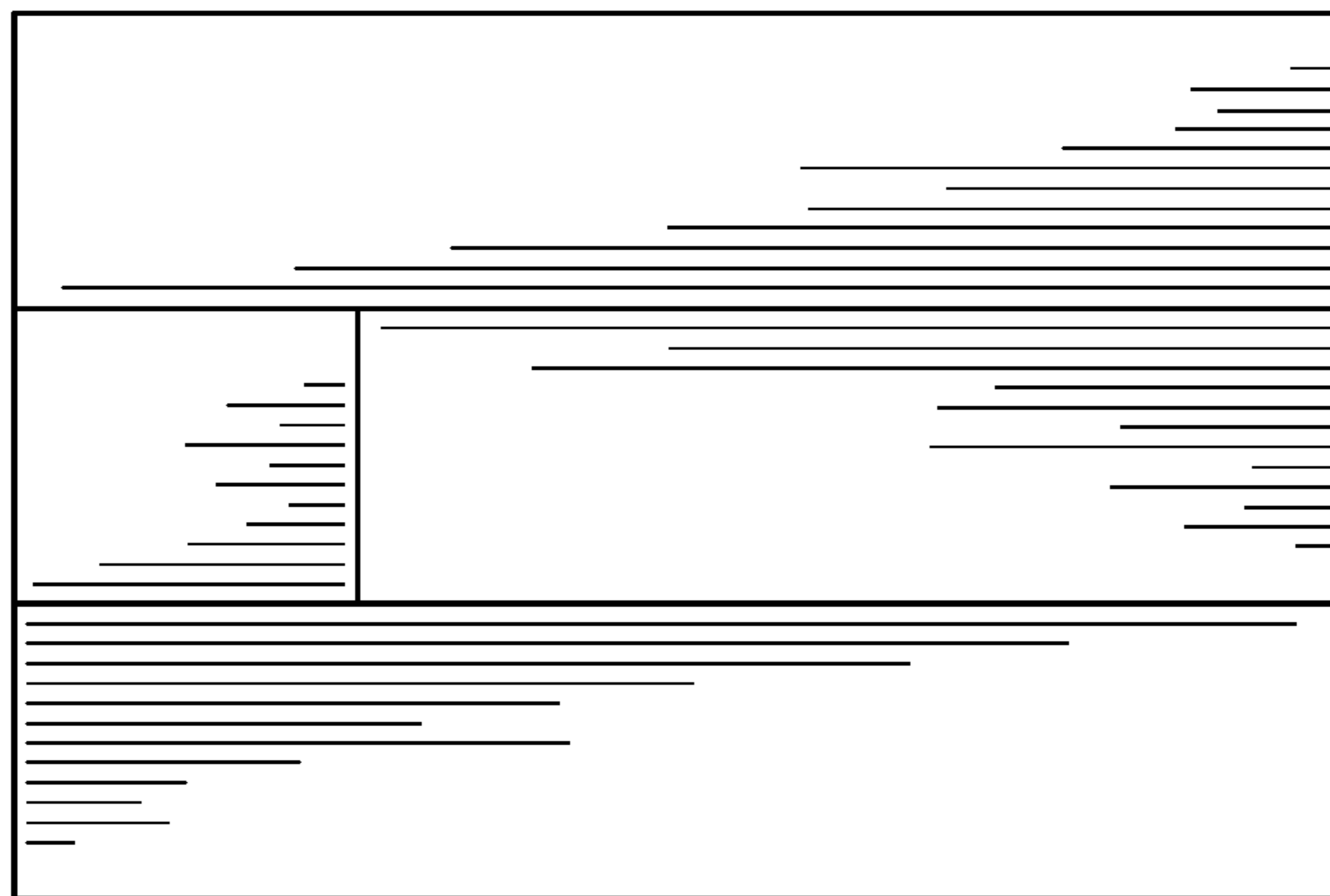

FIG. 8

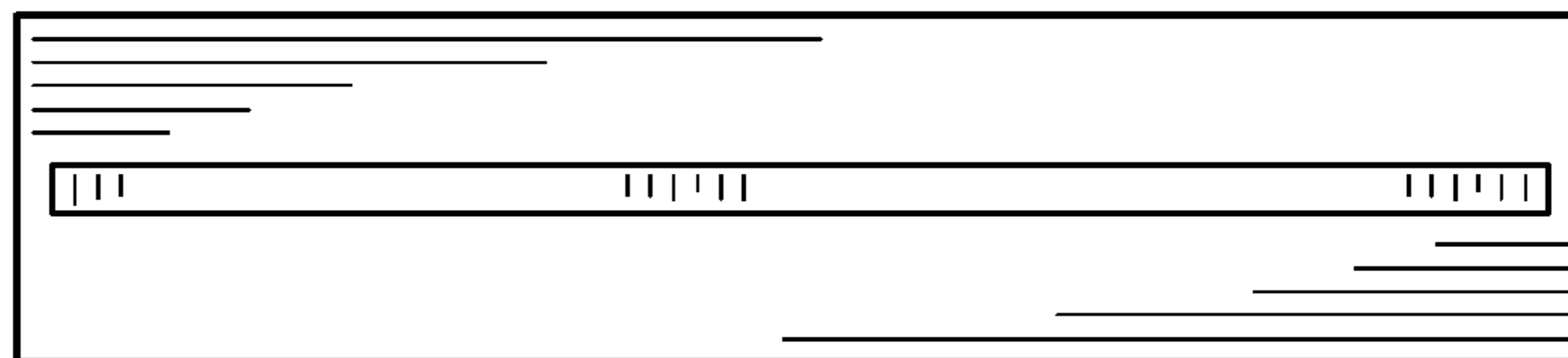

FIG. 9

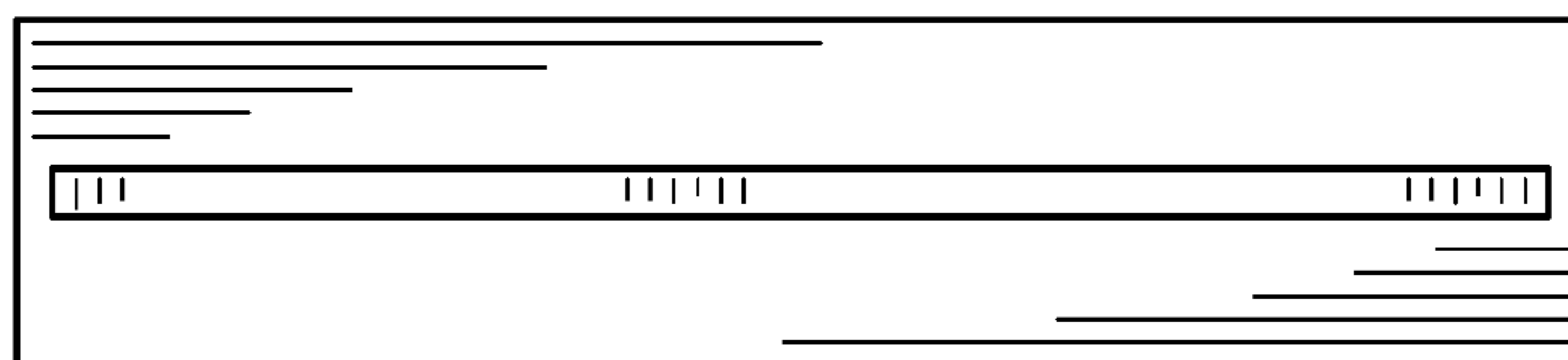

FIG. 10