



US00D630489S

(12) **United States Design Patent**  
**Gratzki et al.**

(10) **Patent No.:** **US D630,489 S**

(45) **Date of Patent:** **\*\* Jan. 11, 2011**

(54) **ELECTRONIC LOCK**

(75) Inventors: **Torsten Gratzki**, Essen (DE); **Jens Deerberg**, Essen (DE); **Helmut Guth**, Wuppertal (DE); **Diethard Geiger**, Velbert (DE)

(73) Assignee: **Schulte-Schlagbaum Aktiengesellschaft**, Velpert (DE)

(\*\*) Term: **14 Years**

(21) Appl. No.: **29/370,192**

(22) Filed: **Jun. 14, 2010**

(30) **Foreign Application Priority Data**

Jan. 18, 2010 (EP) ..... 001190201

(51) **LOC (9) Cl.** ..... **08-07**

(52) **U.S. Cl.** ..... **D8/330**

(58) **Field of Classification Search** ..... D8/330,  
D8/331, 336, 338, 339, 340, 343; 70/14,  
70/2, 51, 57, 57.1, 91, 107, 141; 292/2, 32,  
292/137, 288, 289, 290, 292

See application file for complete search history.

(56) **References Cited**

**U.S. PATENT DOCUMENTS**

- D433,309 S \* 11/2000 Johansson et al. .... D8/331
- D512,899 S \* 12/2005 Oskamp et al. .... D8/331
- 7,221,272 B2 \* 5/2007 Hosselet ..... 340/542
- D545,122 S \* 6/2007 Zemel ..... D7/395
- D549,075 S \* 8/2007 Jackson, Jr. .... D8/331
- 7,296,448 B1 \* 11/2007 Shaw ..... 70/283
- 7,374,084 B2 \* 5/2008 Mitchell ..... 235/382
- D580,739 S \* 11/2008 Pelletier et al. .... D8/331

- 7,482,907 B2 \* 1/2009 Denison et al. .... 340/5.73
- D591,139 S \* 4/2009 Gulley ..... D8/331
- D593,398 S \* 6/2009 Pelletier et al. .... D8/330
- 7,721,576 B2 \* 5/2010 Amir ..... 70/472

\* cited by examiner

*Primary Examiner*—Prabhakar Deshmukh

(74) *Attorney, Agent, or Firm*—Collard & Roe, P.C.

(57) **CLAIM**

The ornamental design for an electronic lock, as shown and described.

**DESCRIPTION**

FIG. 1 is a front view of an electronic lock, showing our new design;

FIG. 2 is a left side view thereof;

FIG. 3 is a top view thereof;

FIG. 4 is a bottom view thereof;

FIG. 5 is a front, top and right side perspective view thereof;

FIG. 6 is a rear, top and left side perspective view thereof;

FIG. 7 is a front view of another embodiment of an electronic lock, showing our new design;

FIG. 8 is a left side view thereof;

FIG. 9 is a top view thereof;

FIG. 10 is a bottom view thereof;

FIG. 11 is a front, top and right side perspective view thereof; and,

FIG. 12 is a rear, top and left side perspective view thereof.

The portions shown in broken lines are for illustrative purpose only and form no part of the claimed design.

**1 Claim, 6 Drawing Sheets**

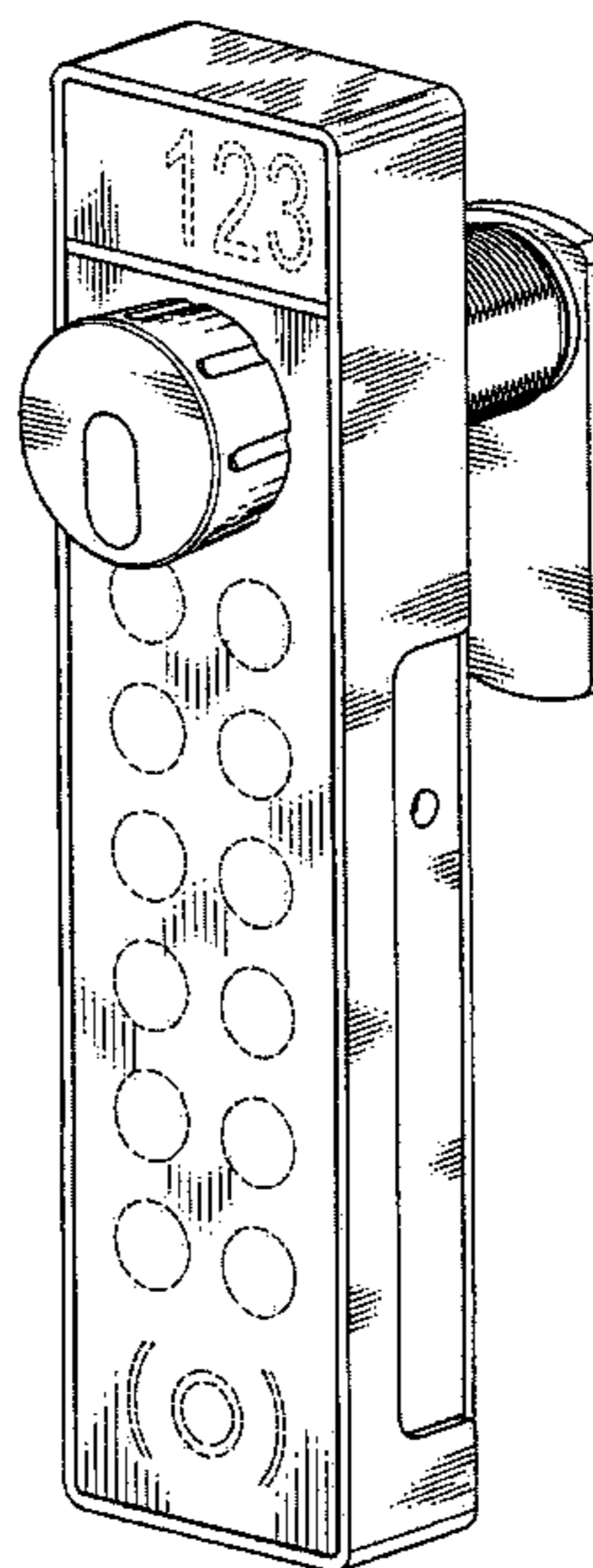
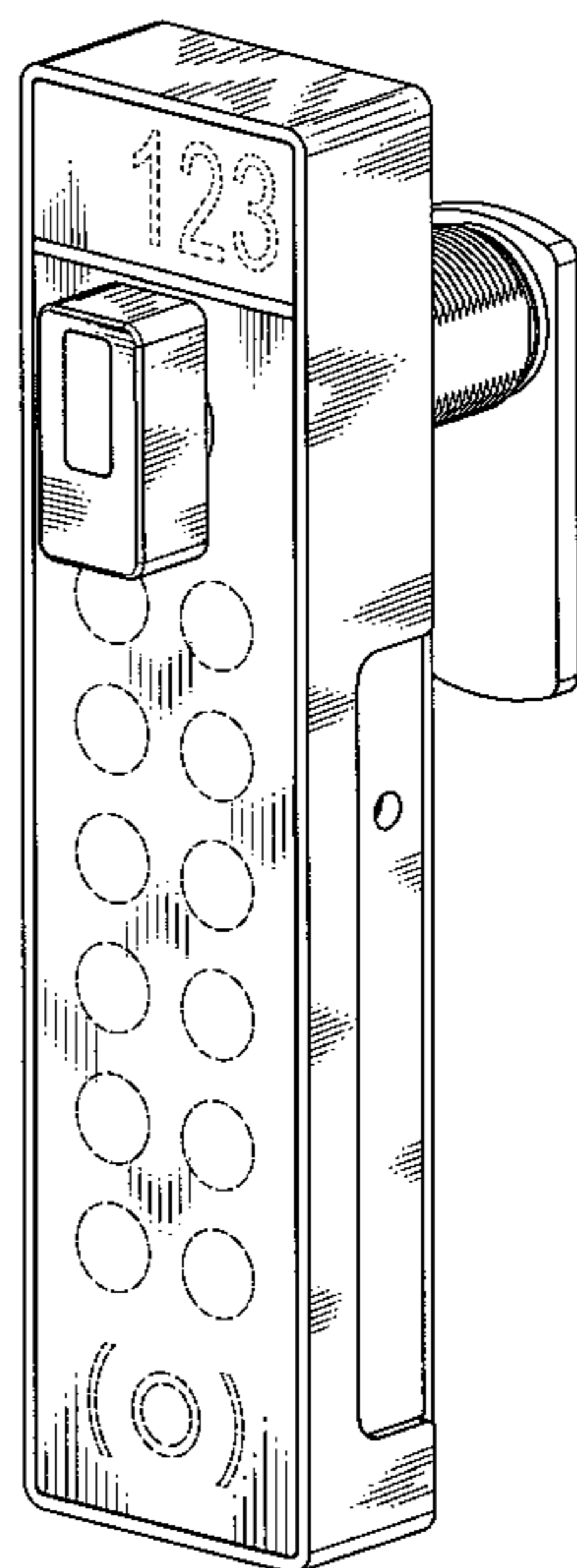

***Fig. 1***

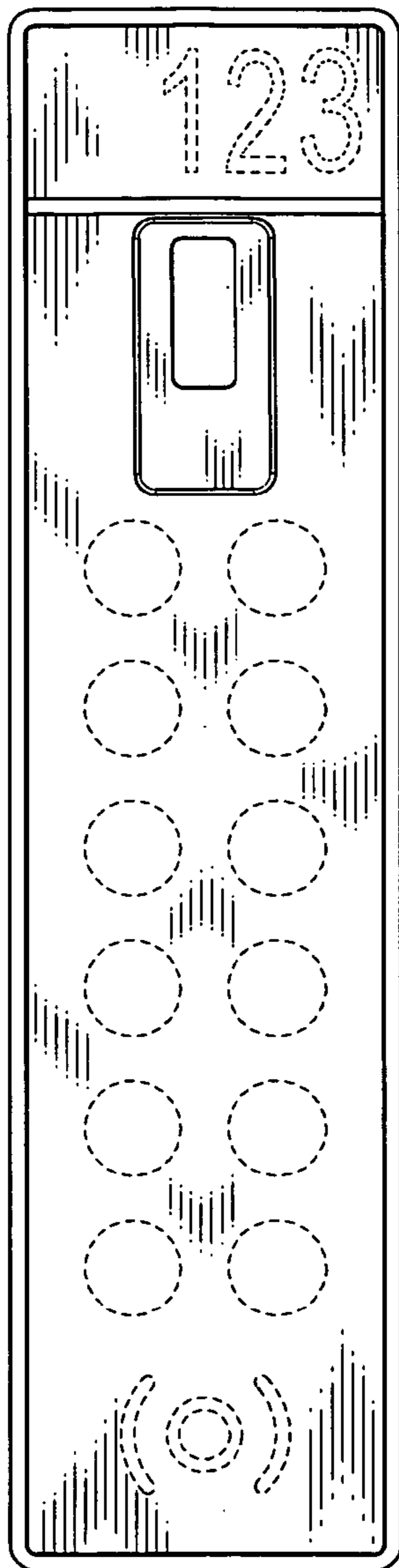

***Fig. 2***

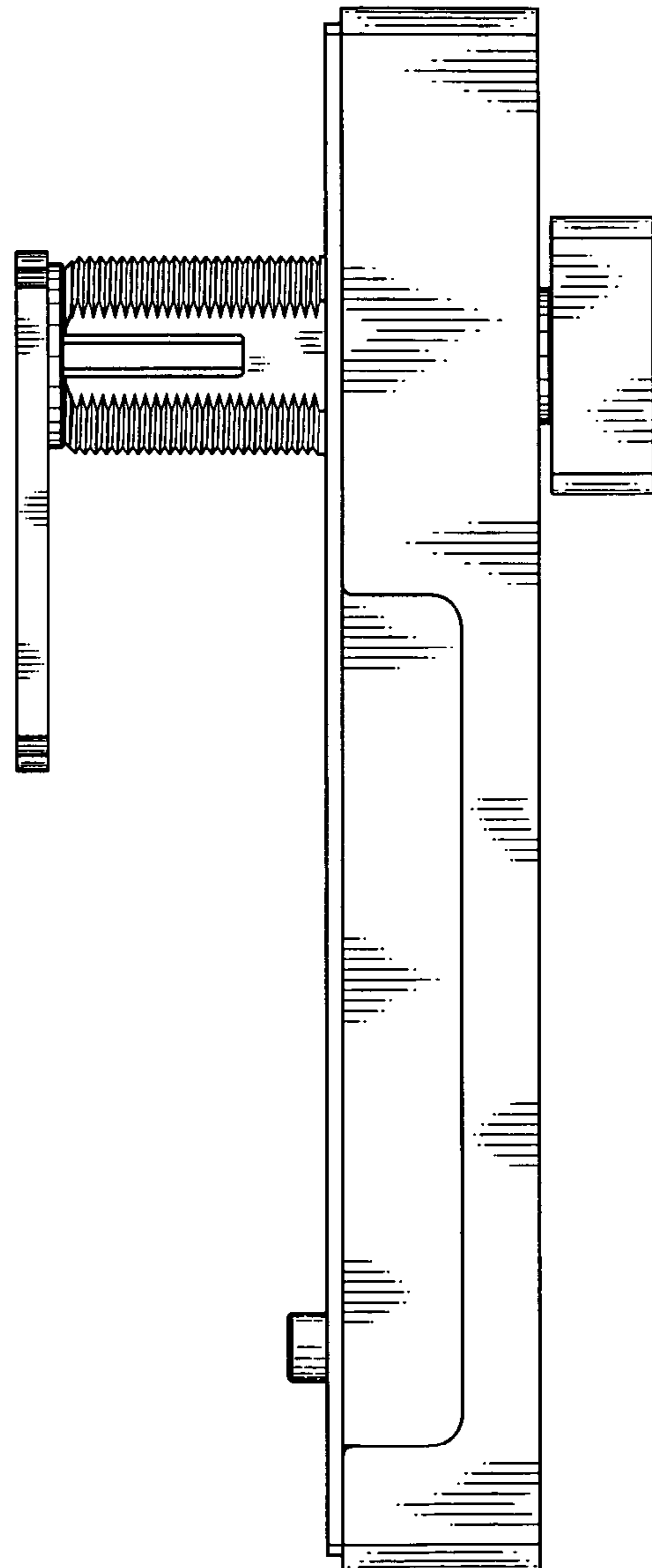

***Fig. 3***

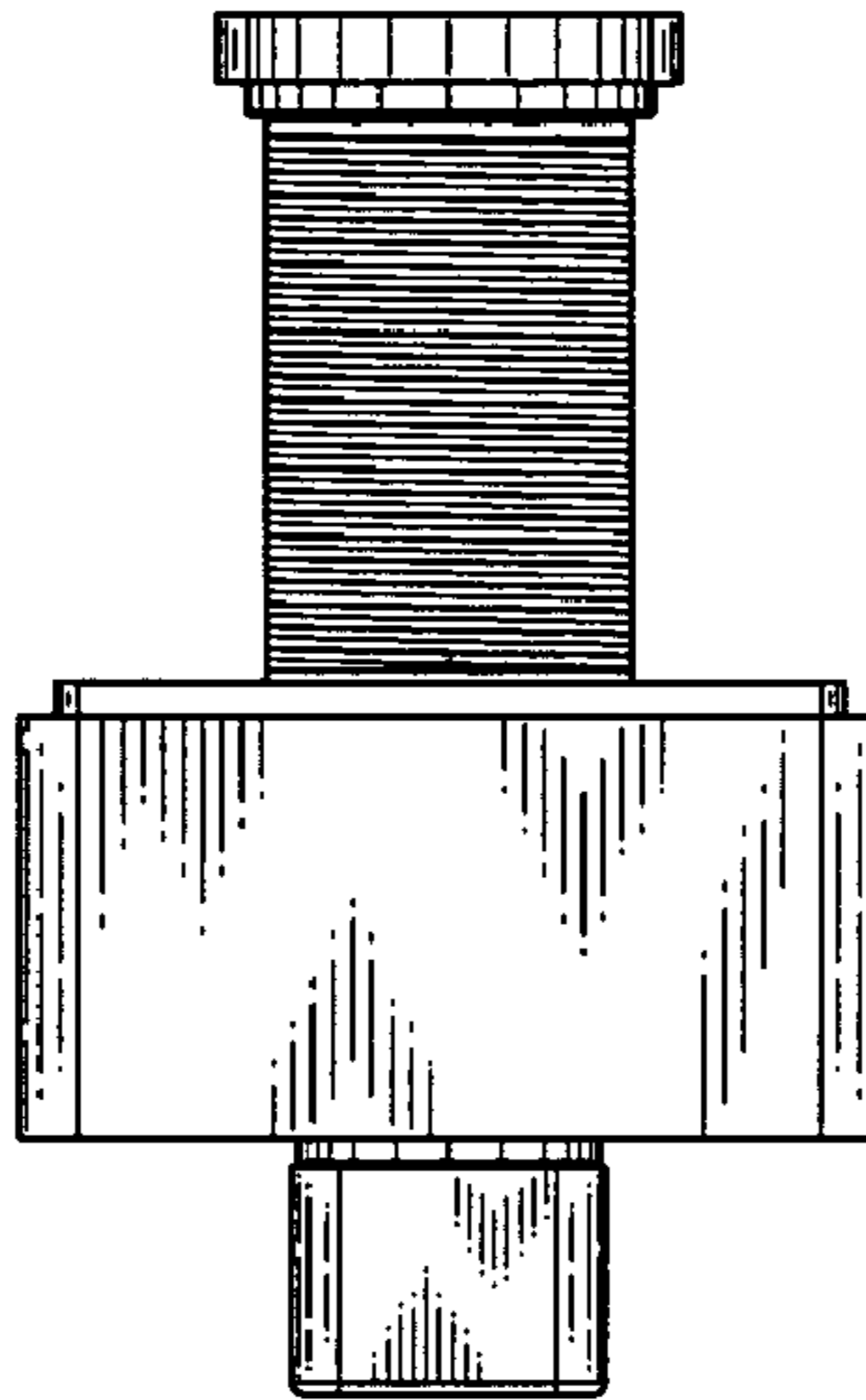

***Fig. 4***

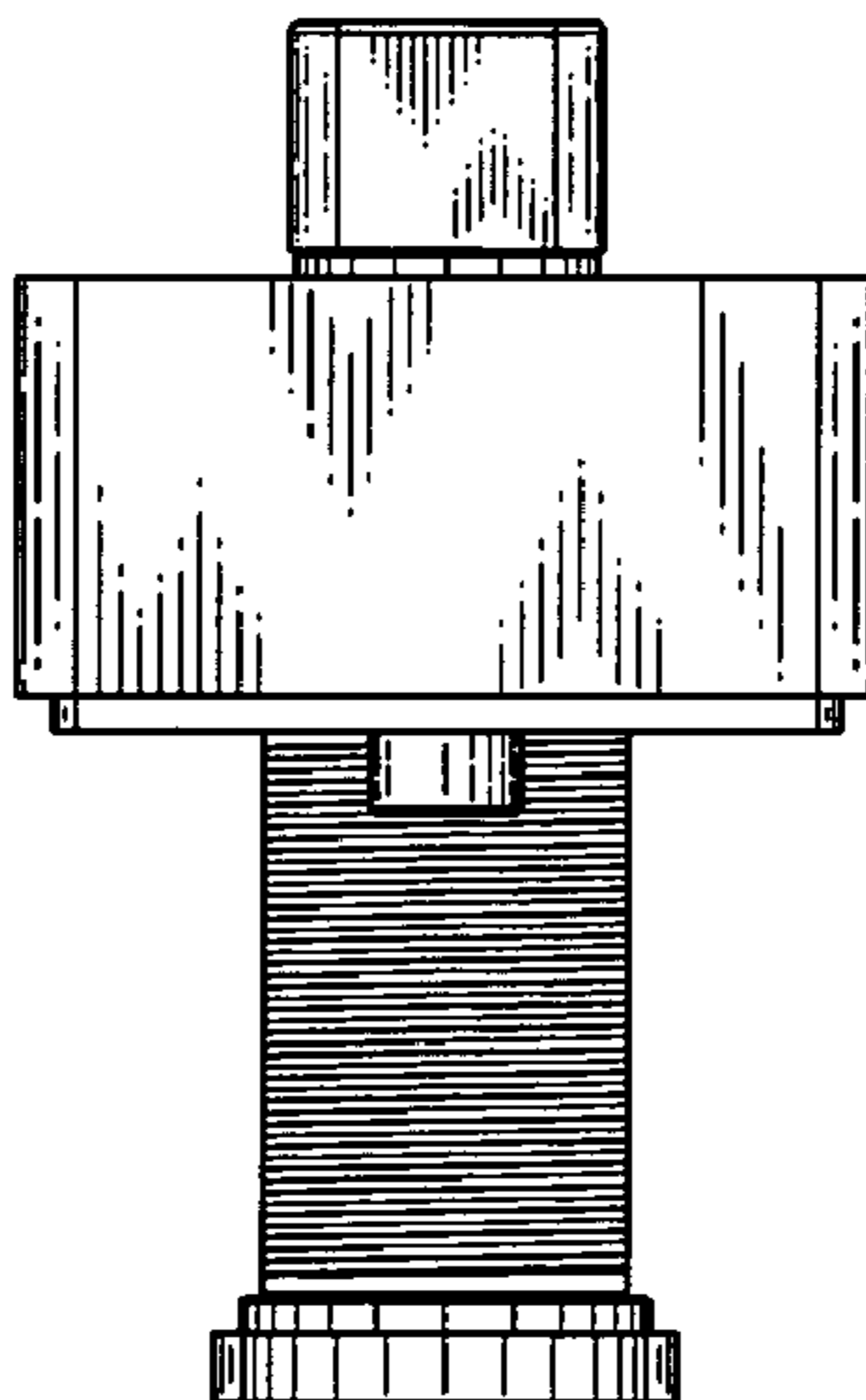

***Fig. 5***

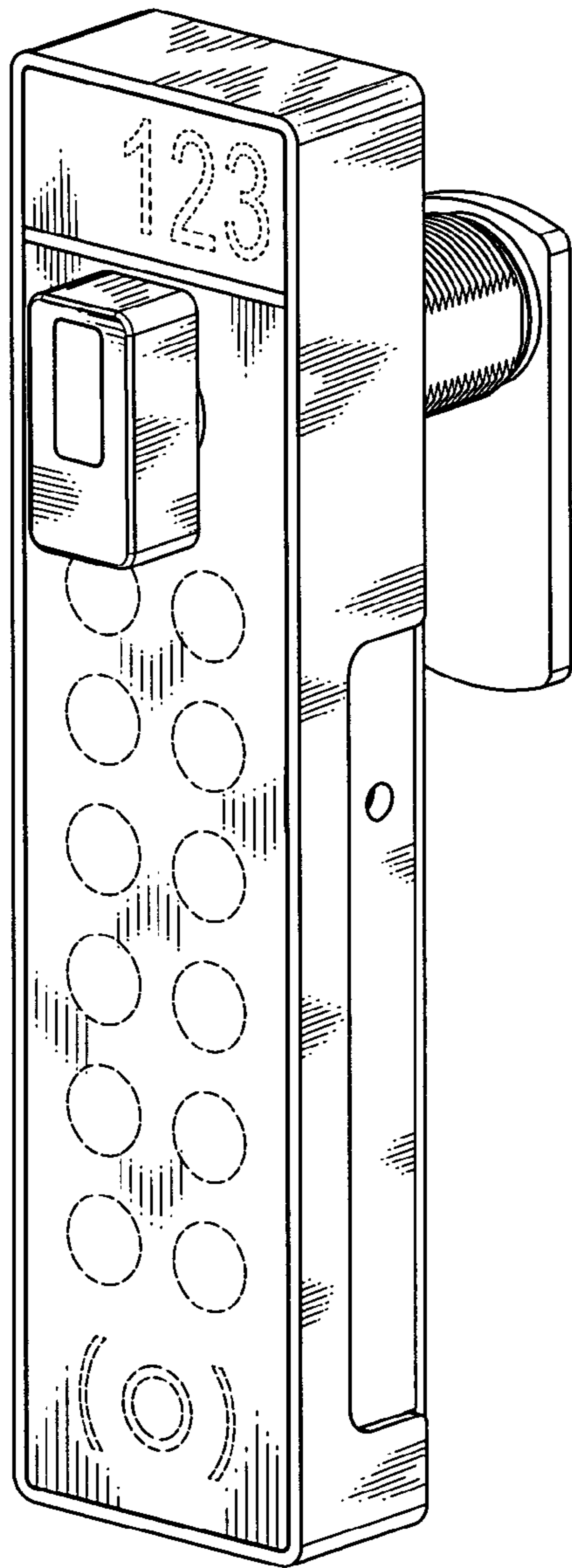

***Fig. 6***

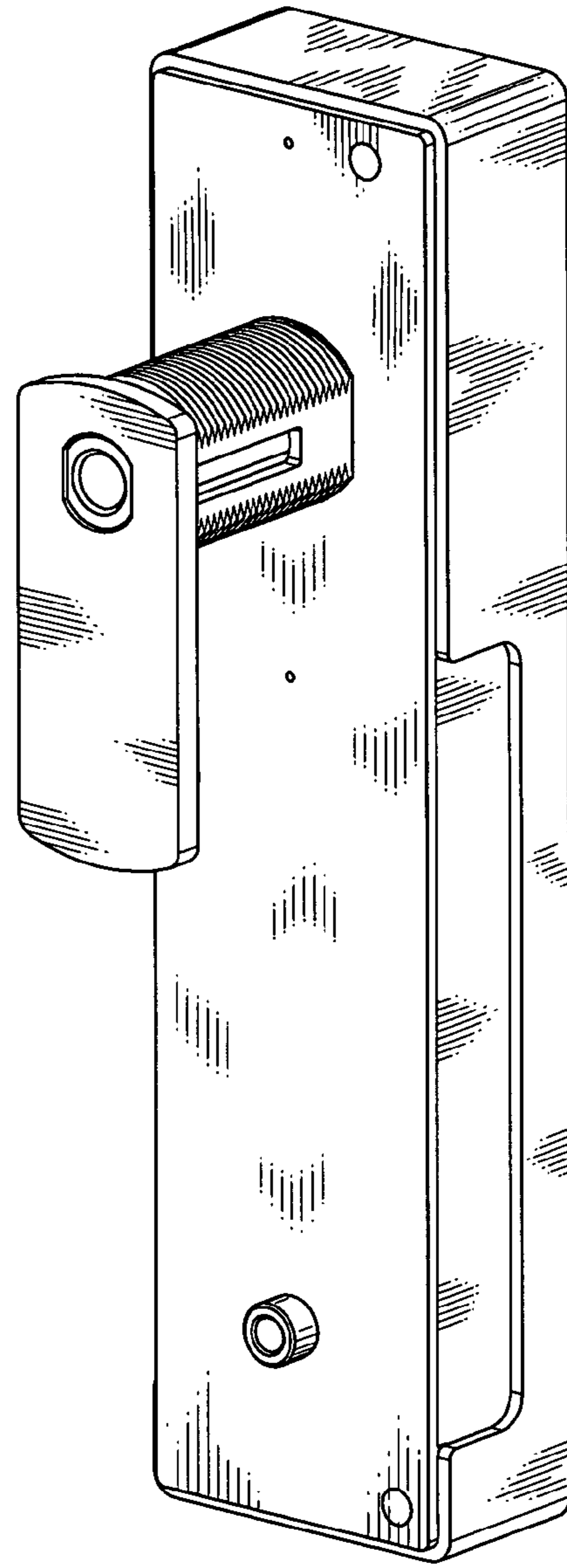

***Fig. 7***

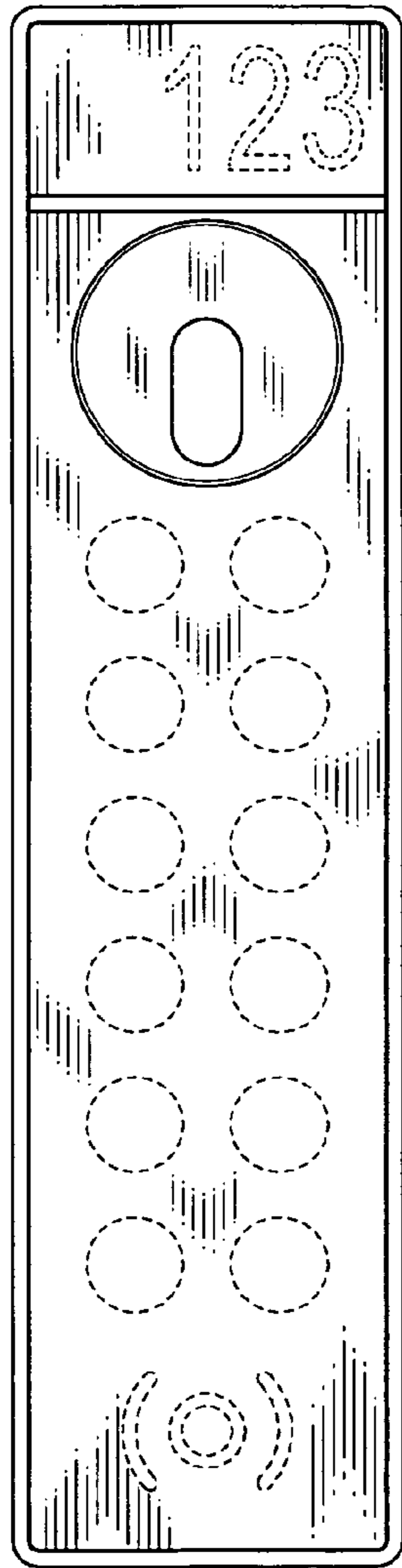

***Fig. 8***

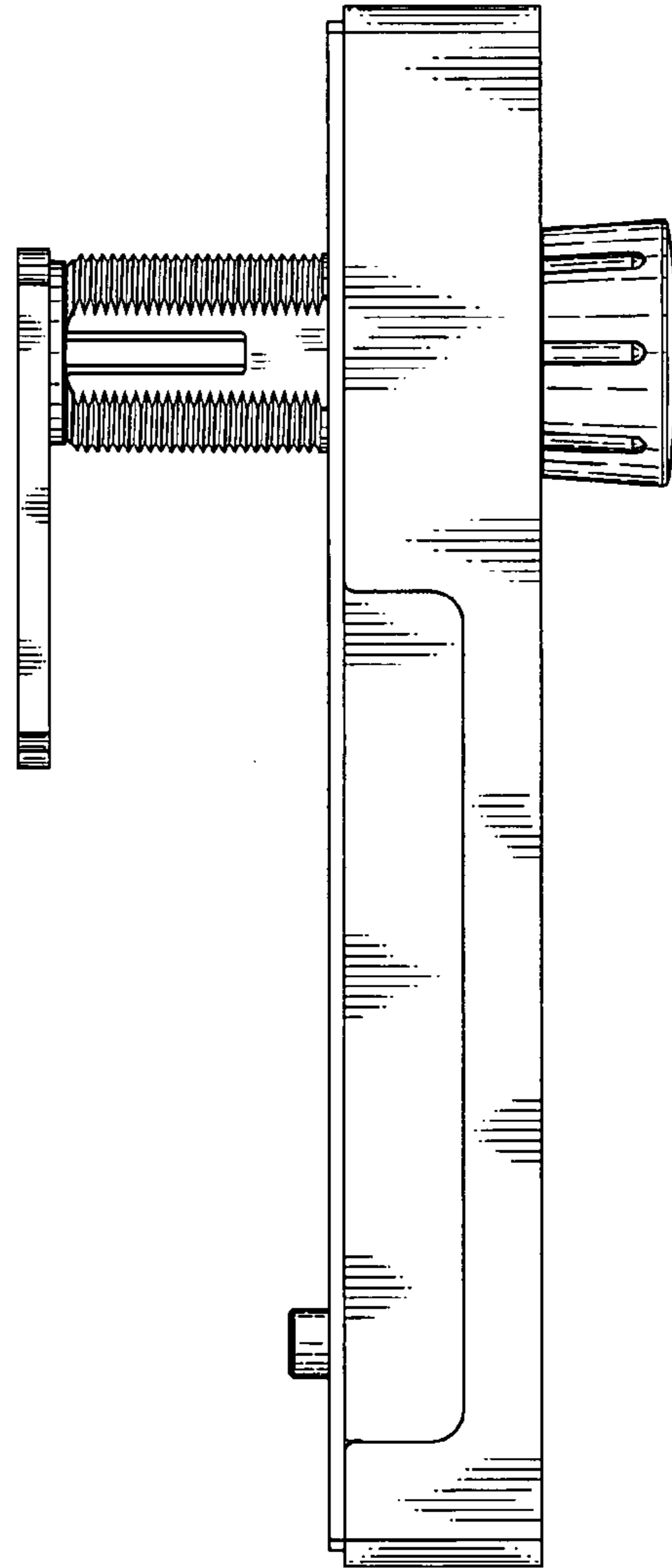

***Fig. 9***

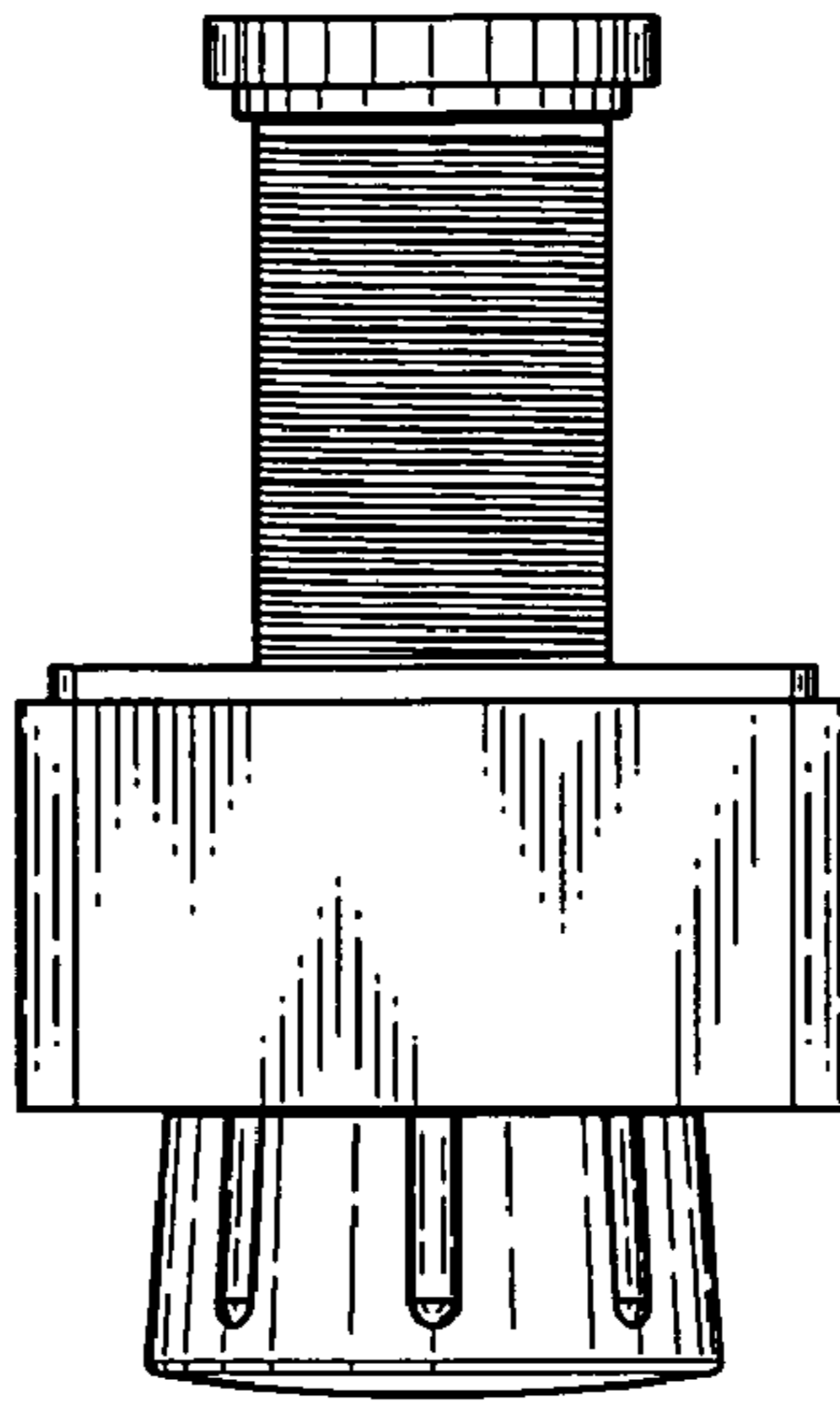

***Fig. 10***

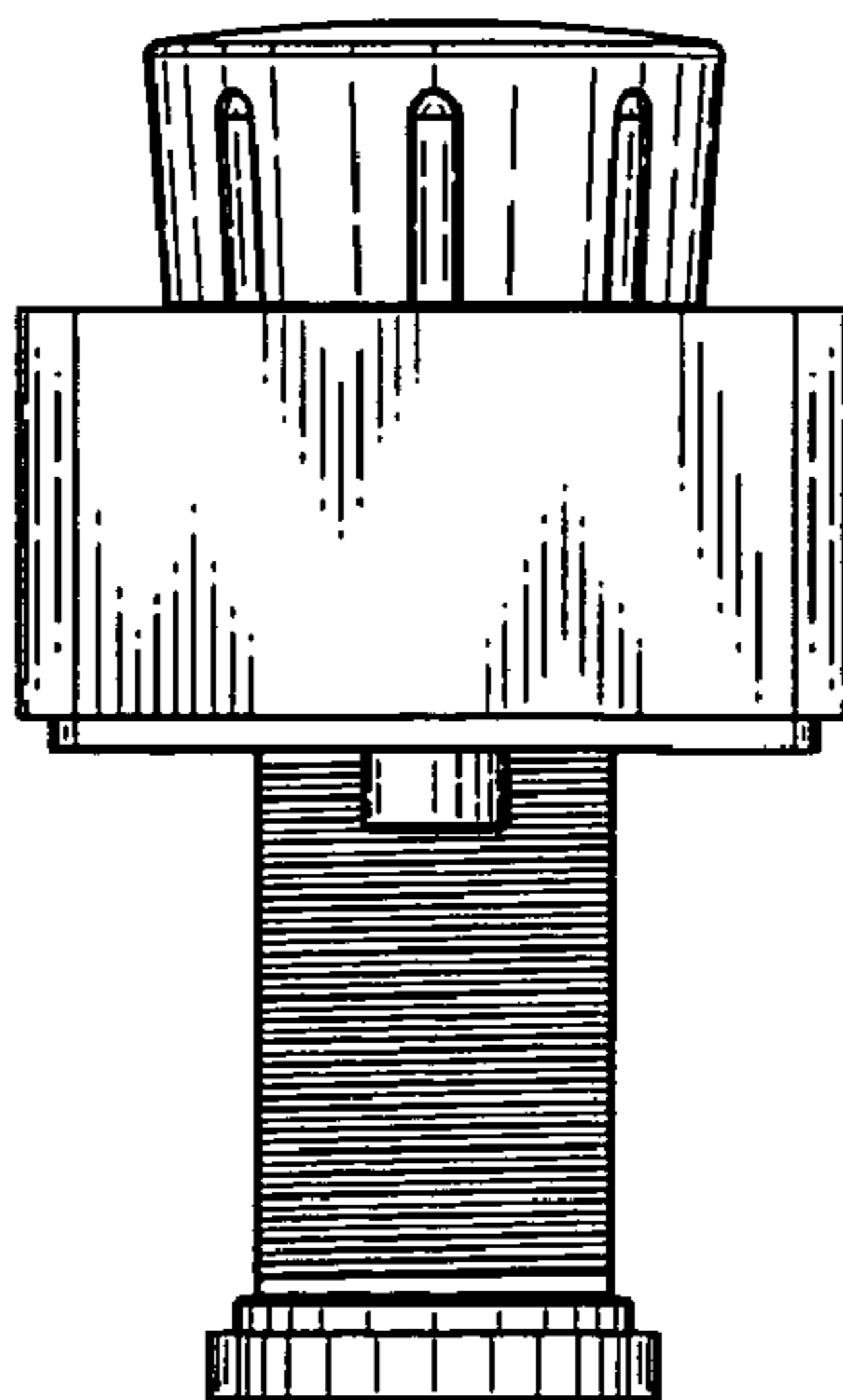

***Fig. 11***

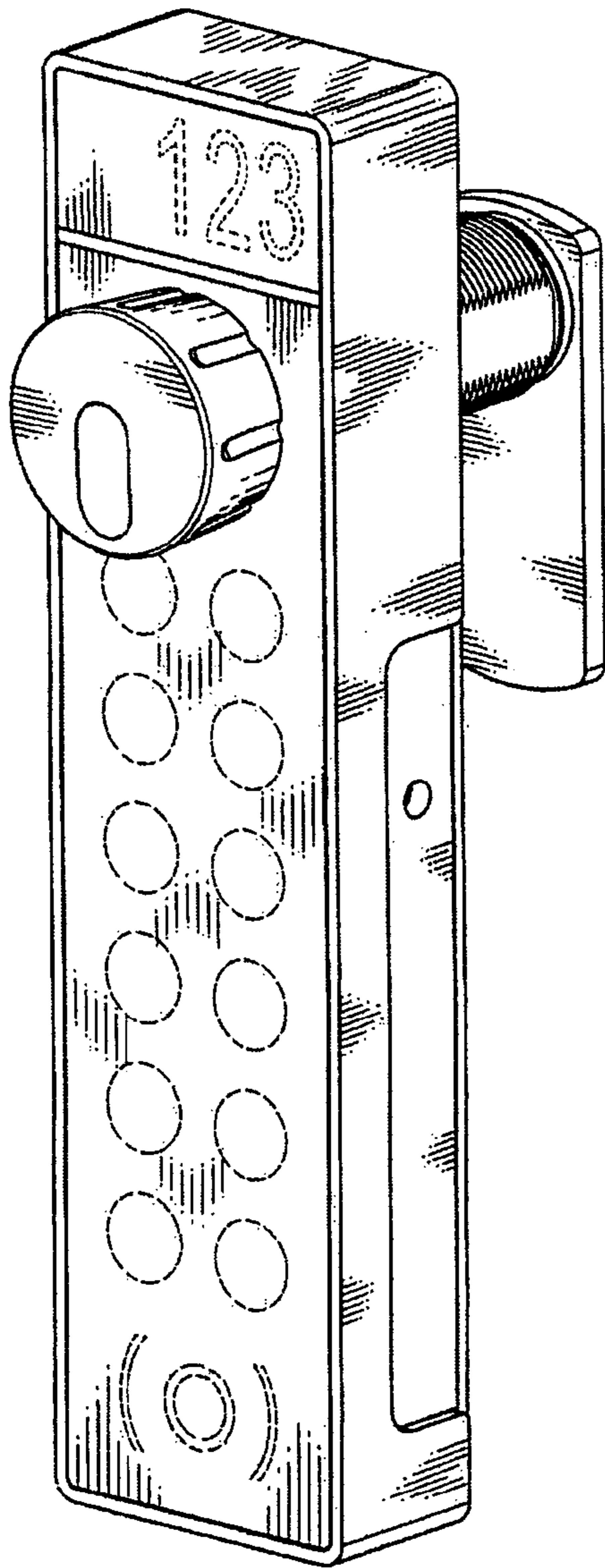

***Fig. 12***

