



US00D630479S

(12) **United States Design Patent**
Yang

(10) **Patent No.:** **US D630,479 S**
(45) **Date of Patent:** **** Jan. 11, 2011**

(54) **SNIP SCISSORS**

D570,167 S * 6/2008 Kaposi D8/5
D600,092 S * 9/2009 Peterson et al. D8/107

(76) Inventor: **Ching-Chen Yang**, No. 17, Lane 98,
Sec. 2, Dacing Street, South District,
Taichung City 402 (TW)

* cited by examiner

(**) Term: **14 Years**

Primary Examiner—Holly H Baynham
Assistant Examiner—Sheryl Lane
(74) *Attorney, Agent, or Firm*—Banger Shia

(21) Appl. No.: **29/359,846**

(57) **CLAIM**

(22) Filed: **Apr. 15, 2010**

I claim the ornamental design for a snip scissors, as shown
and described.

(30) **Foreign Application Priority Data**

Oct. 28, 2009 (TW) 98305112

DESCRIPTION

(51) **LOC (9) Cl.** **08-01**

FIG. 1 is a perspective view of a snip scissors, showing my
new design;

(52) **U.S. Cl.** **D8/5**

(58) **Field of Classification Search** D8/5,
D8/52, 54, 68; 30/203, 131, 260, 262, 193–194,
30/296.1, 134
See application file for complete search history.

FIG. 2 is a front elevational view thereof;

FIG. 3 is a rear elevational view thereof;

FIG. 4 is a left side elevational view thereof;

FIG. 5 is a right side elevational view thereof;

FIG. 6 is a top plan view thereof; and,

FIG. 7 is a bottom plan view thereof.

(56) **References Cited**

U.S. PATENT DOCUMENTS

D494,032 S * 8/2004 Rivera D8/58
D555,442 S * 11/2007 Kaposi D8/5

1 Claim, 5 Drawing Sheets

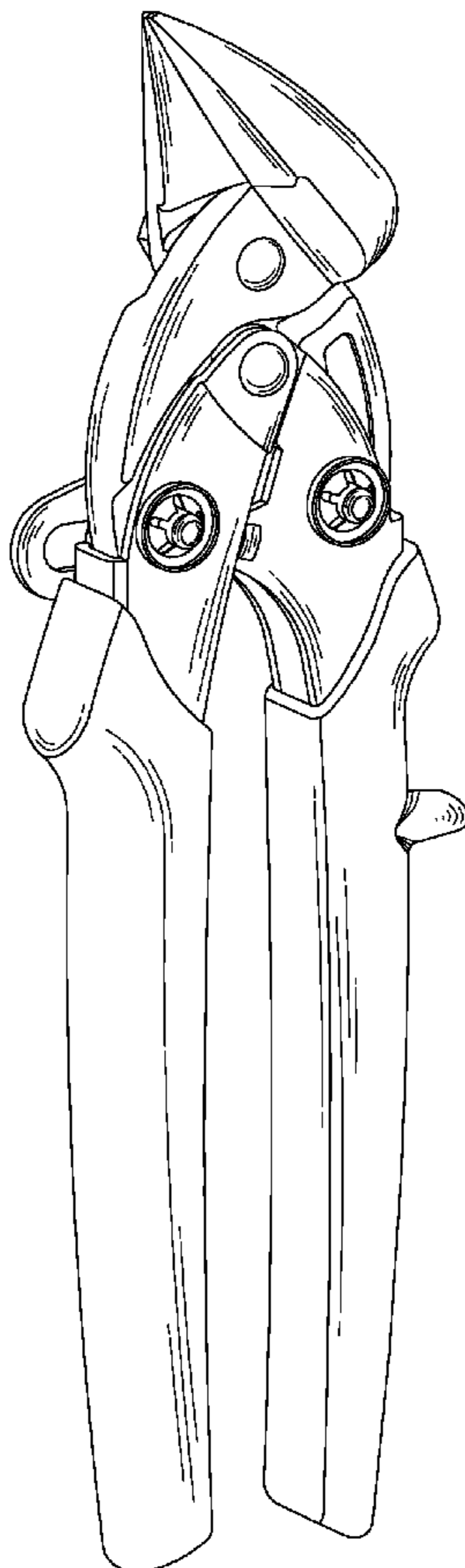

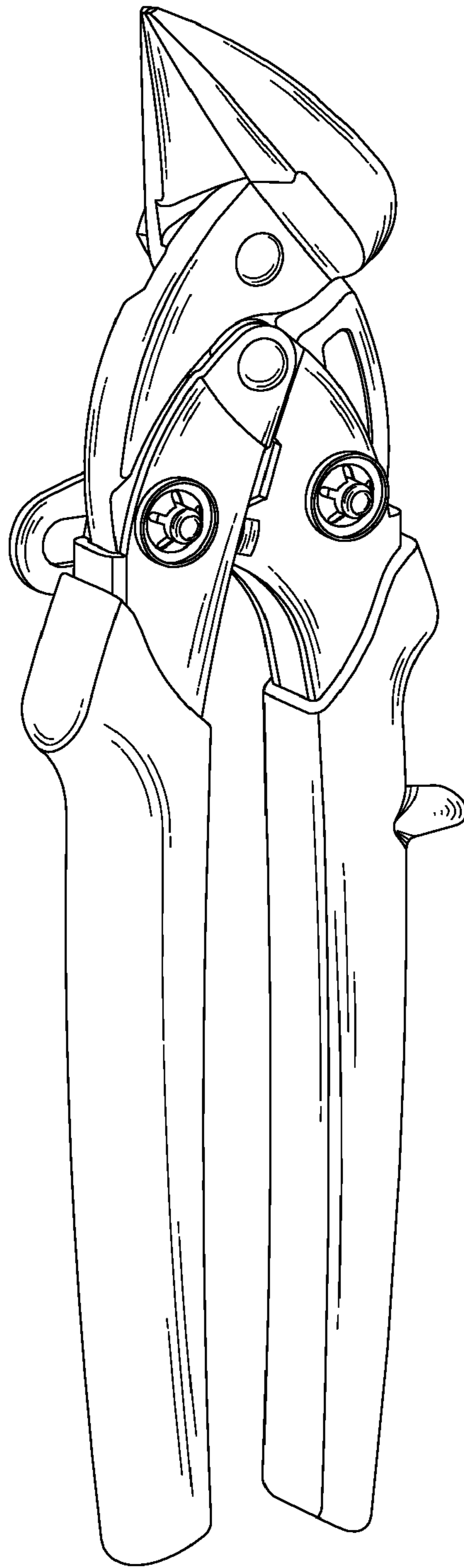

FIG.1

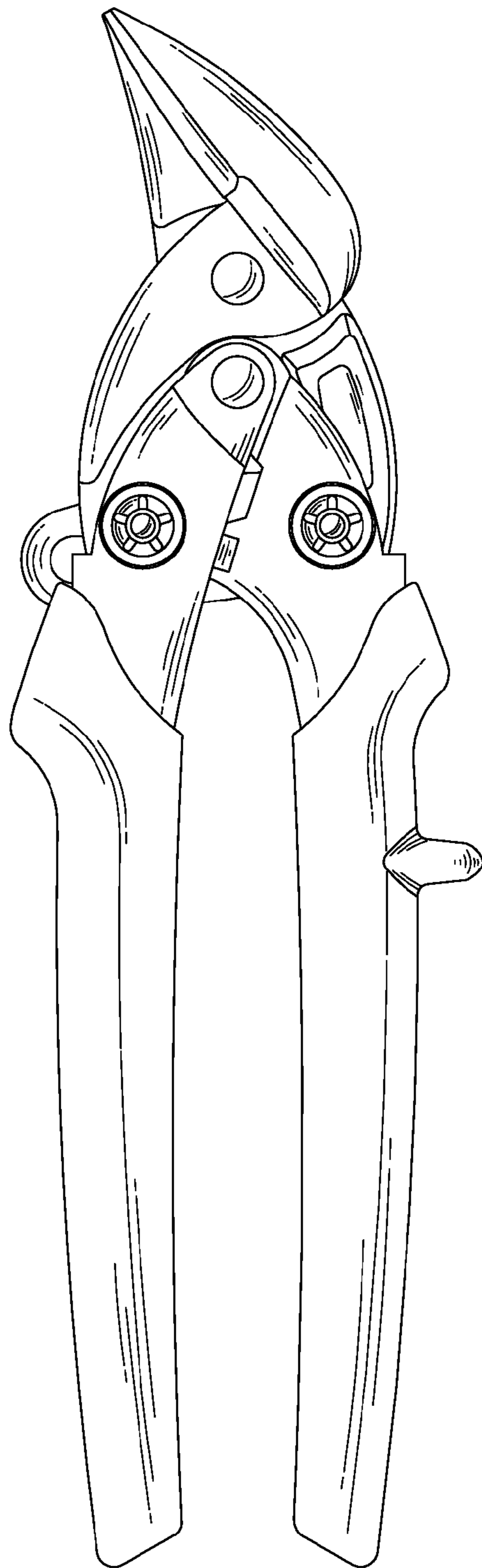

FIG.2

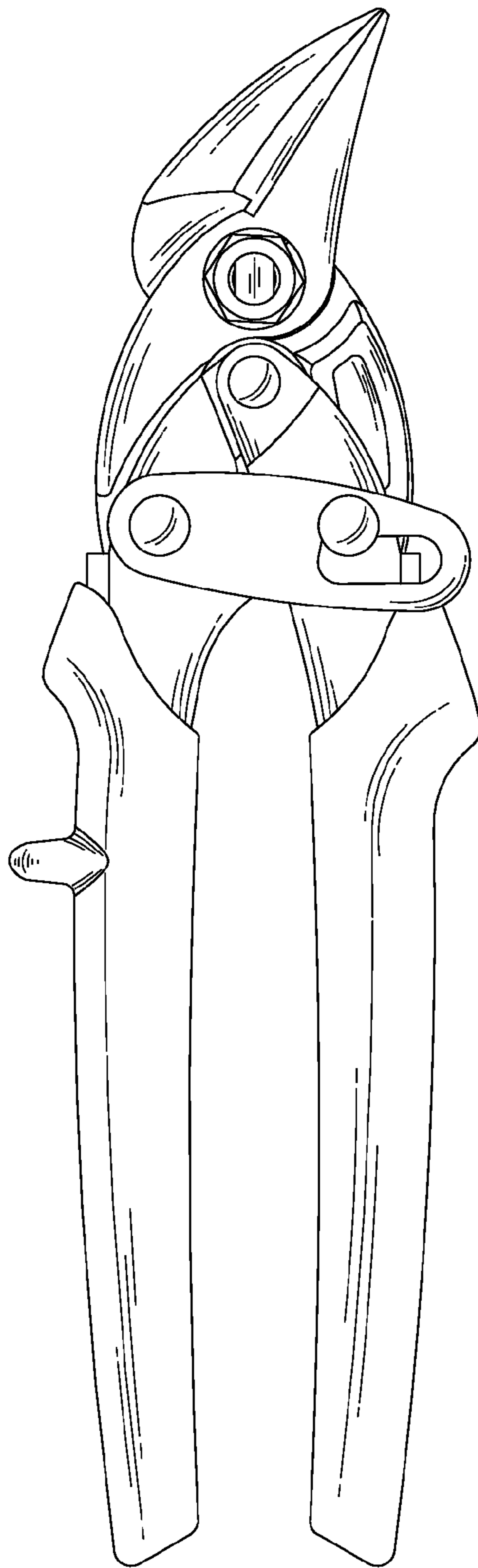

FIG.3

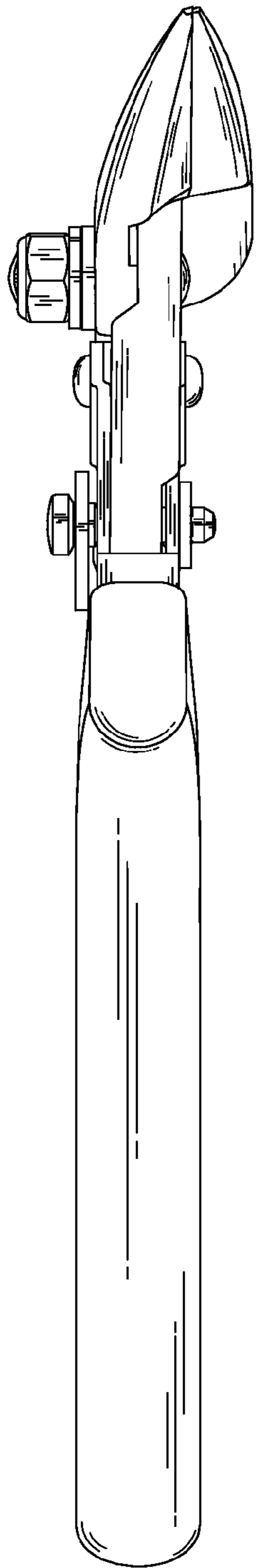

FIG.4

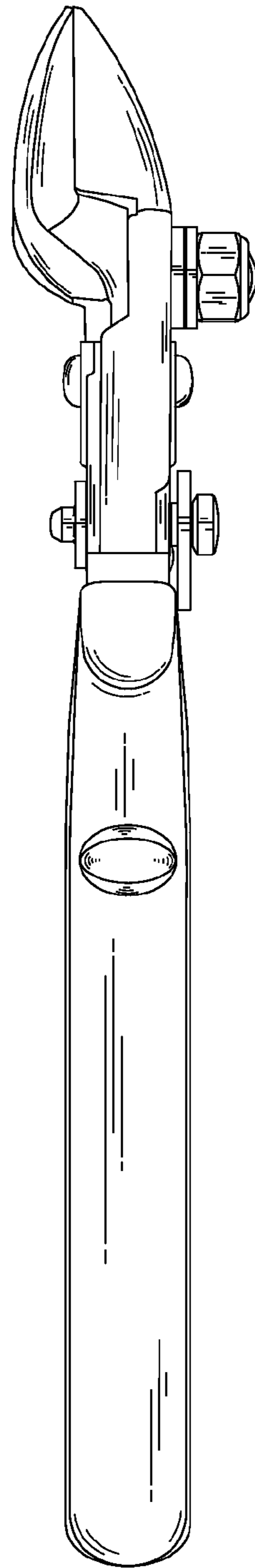

FIG.5

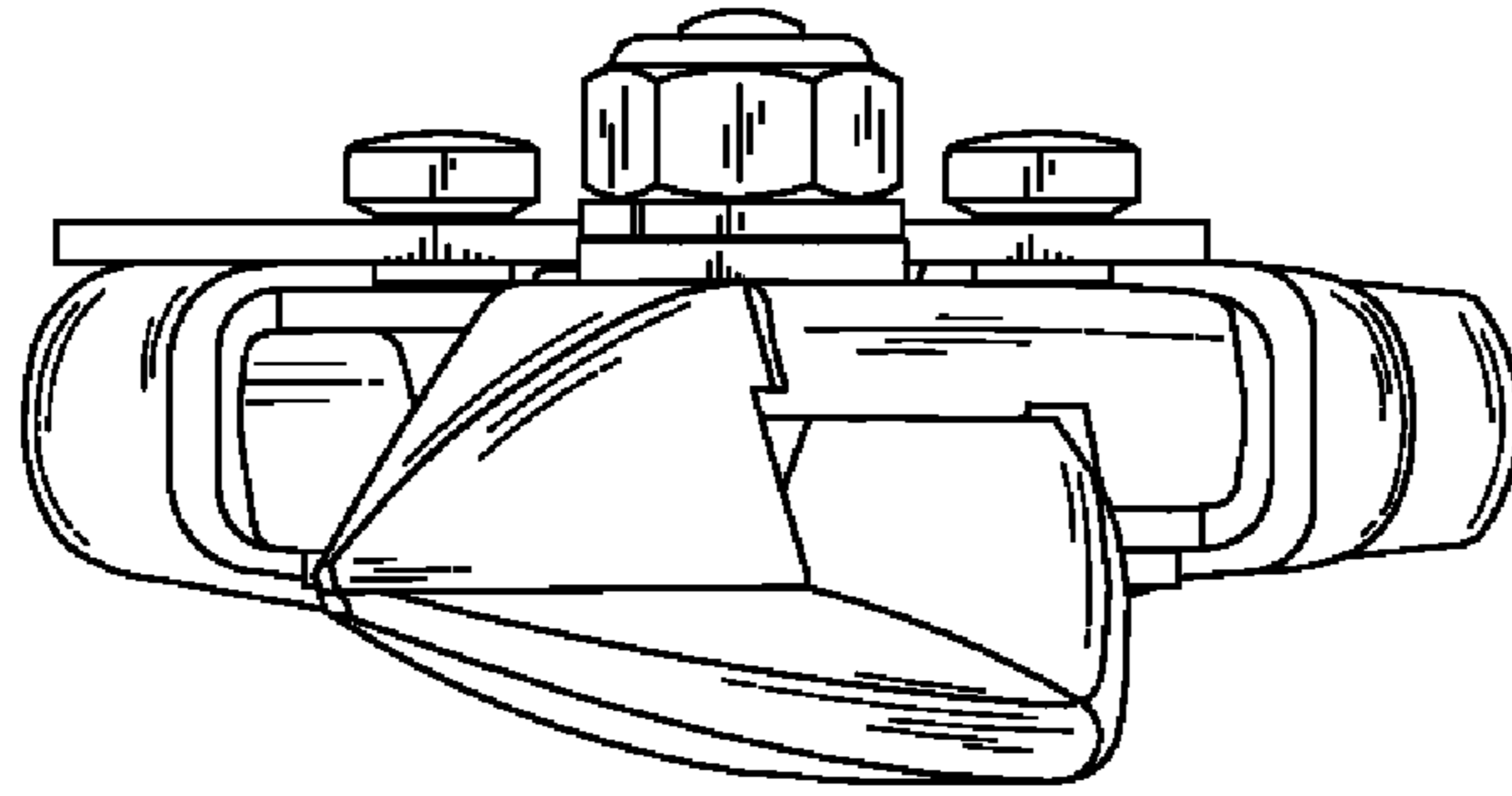

FIG.6

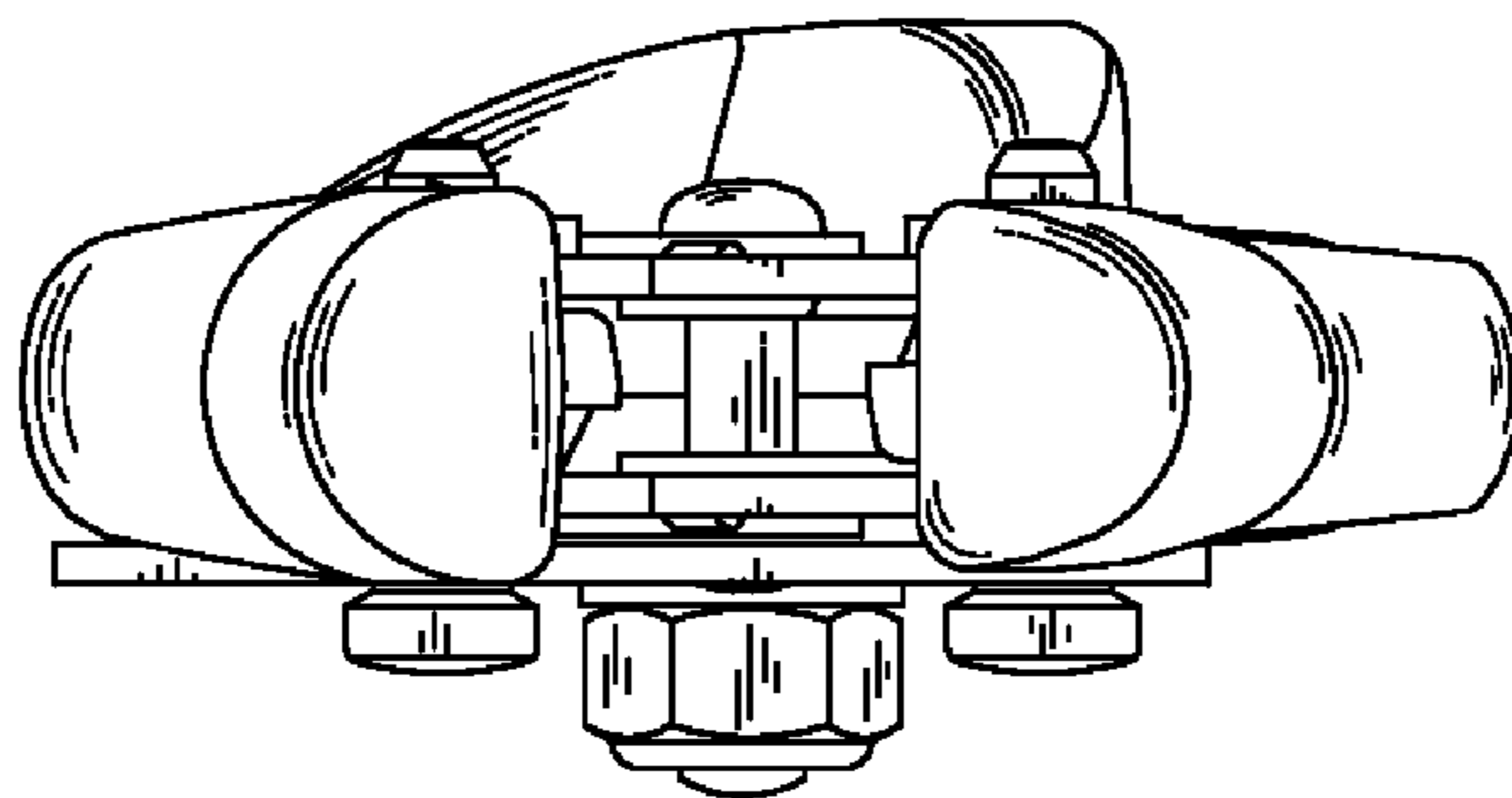

FIG.7