



US00D630478S

(12) **United States Design Patent**  
**Bell**

(10) **Patent No.:** **US D630,478 S**

(45) **Date of Patent:** **\*\* Jan. 11, 2011**

(54) **CUTTING BOARD**

(76) **Inventor:** **Lisa D. Bell**, 4309 Sunridge Dr.,  
Apartment #A, St. Louis, MO (US)  
63125

(\*\*) **Term:** **14 Years**

(21) **Appl. No.:** **29/375,920**

(22) **Filed:** **Sep. 29, 2010**

(51) **LOC (9) Cl.** ..... **07-04**

(52) **U.S. Cl.** ..... **D7/698**

(58) **Field of Classification Search** ..... D7/388-389,  
D7/412, 550.1, 586-587, 637-638, 672-673,  
D7/698-699; D19/65, 75, 86, 90; 4/514;  
83/762; 99/425-426, 444, 446, 449-450;  
269/16, 289 R, 290-292, 295, 297, 302.1,  
269/900

See application file for complete search history.

(56) **References Cited**

**U.S. PATENT DOCUMENTS**

212,327	A	2/1879	Shevill	
426,536	A	4/1890	Johnson	
495,390	A	4/1893	Brueck	
615,499	A	12/1898	Schmid	
668,322	A *	2/1901	Stephen	4/514
836,628	A	11/1906	Brueck	
2,398,192	A *	4/1946	Scheminger, Jr.	83/762
2,651,784	A	9/1953	Johnson et al.	
2,765,476	A	10/1956	Moore	
4,133,238	A *	1/1979	Jacobs	83/762
4,333,188	A	6/1982	Jensen et al.	

D315,275	S *	3/1991	Aziz et al.	D7/673
5,382,009	A *	1/1995	Mertz et al.	269/16
5,423,095	A *	6/1995	Bearer	4/514
D362,374	S *	9/1995	Roach	D7/673
7,721,362	B2 *	5/2010	Martin et al.	4/514
D616,700	S *	6/2010	Pourounidis et al.	D7/388
D623,029	S *	9/2010	Russell et al.	D7/698
2009/0049596	A1	2/2009	Ferris	

\* cited by examiner

*Primary Examiner*—Ricky Pham

(74) *Attorney, Agent, or Firm*—Sennigers Powers LLP

(57) **CLAIM**

The ornamental design for a cutting board, as shown and described.

**DESCRIPTION**

FIG. 1 is a perspective of a cutting board inserted in a sink, the sink being shown in phantom;

FIG. 2 is a perspective of the cutting board removed from the sink;

FIG. 3 is a front elevation thereof;

FIG. 4 is a right elevation thereof, the left elevation thereof being a mirror image;

FIG. 5 is top view thereof;

FIG. 6 is bottom view thereof; and,

FIG. 7 is a rear elevation thereof.

The phantom lines in the drawings indicate environmental structure which forms no part of the claimed design.

**1 Claim, 7 Drawing Sheets**

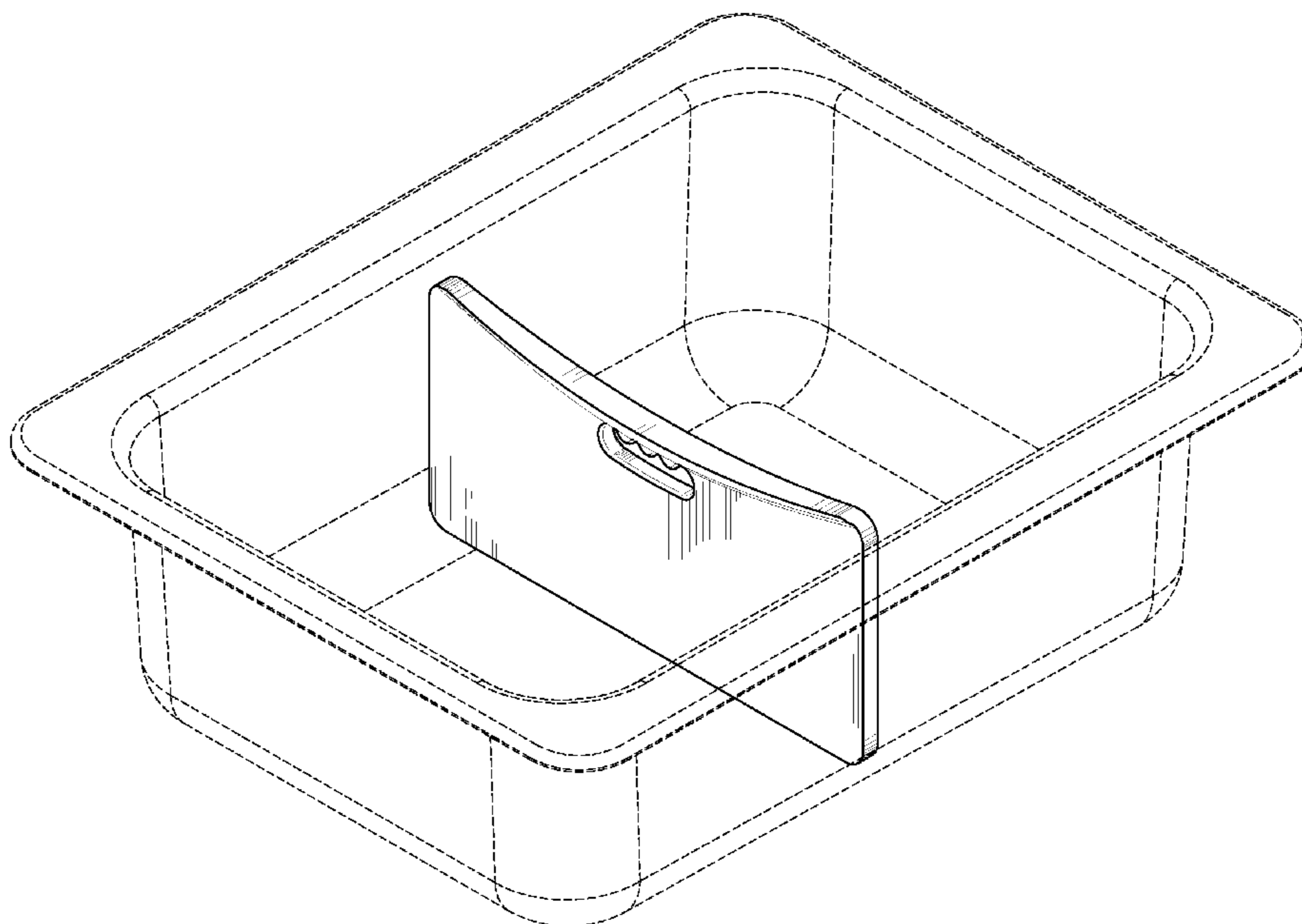

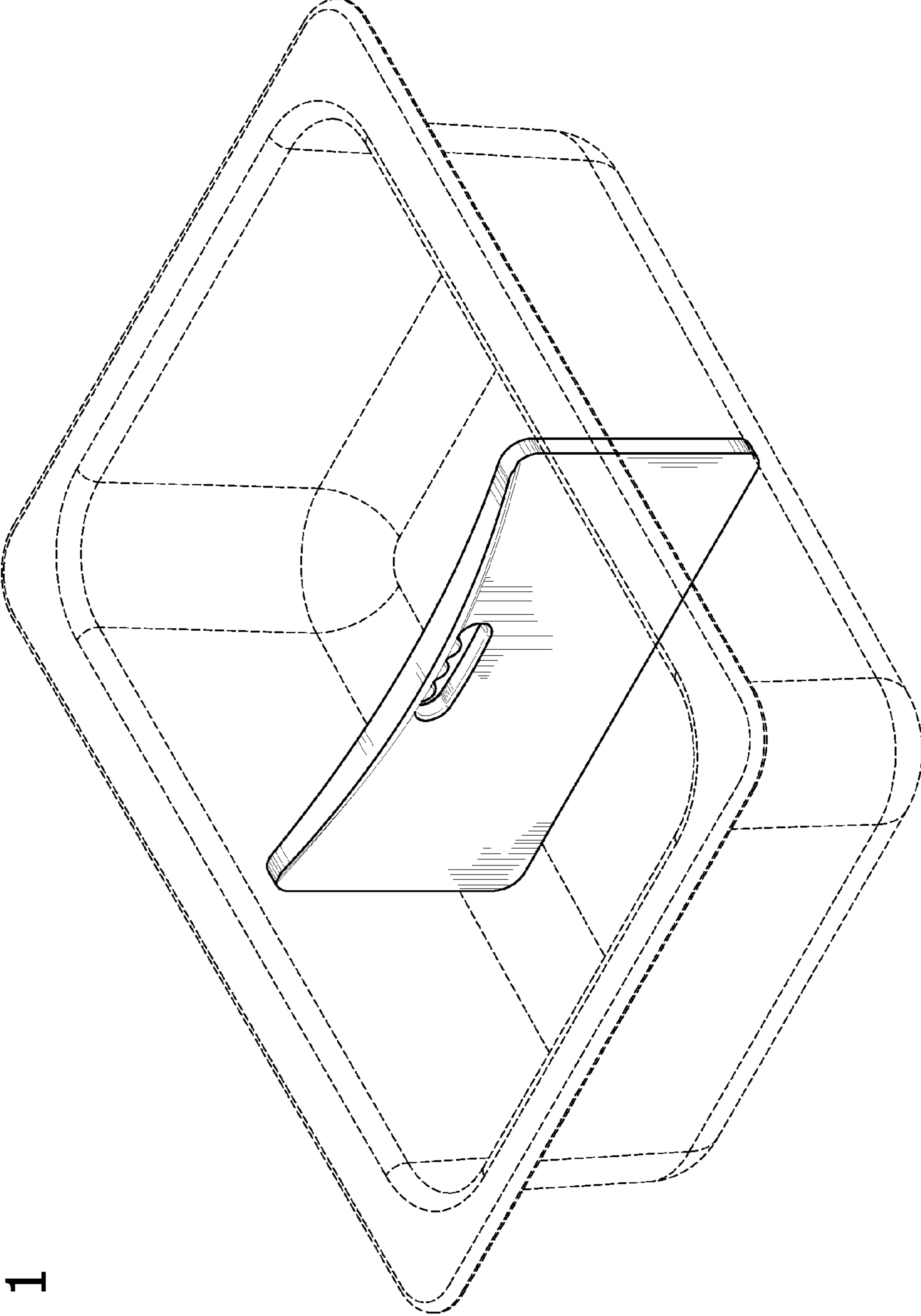

FIG. 1

FIG. 2

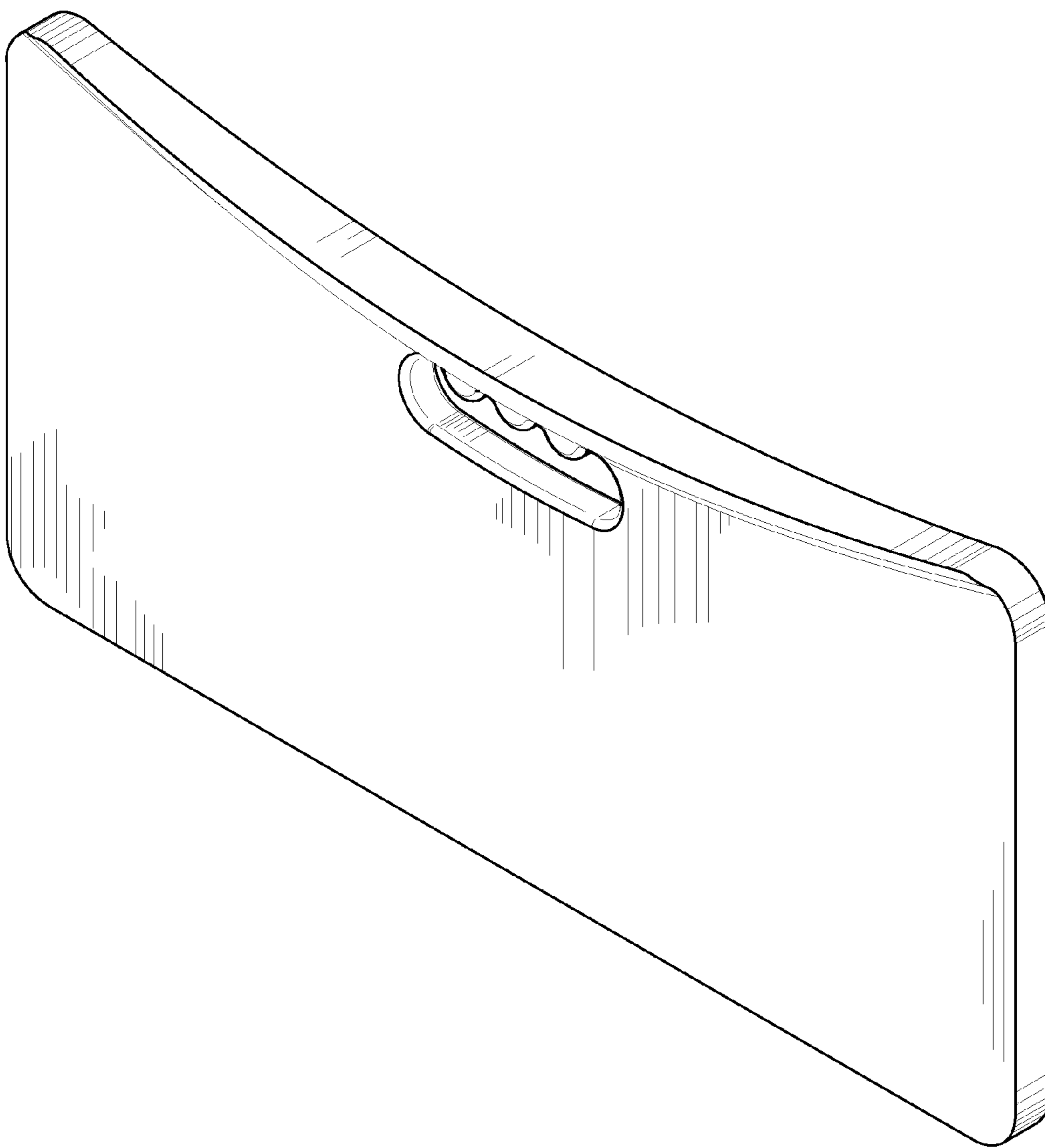

FIG. 3

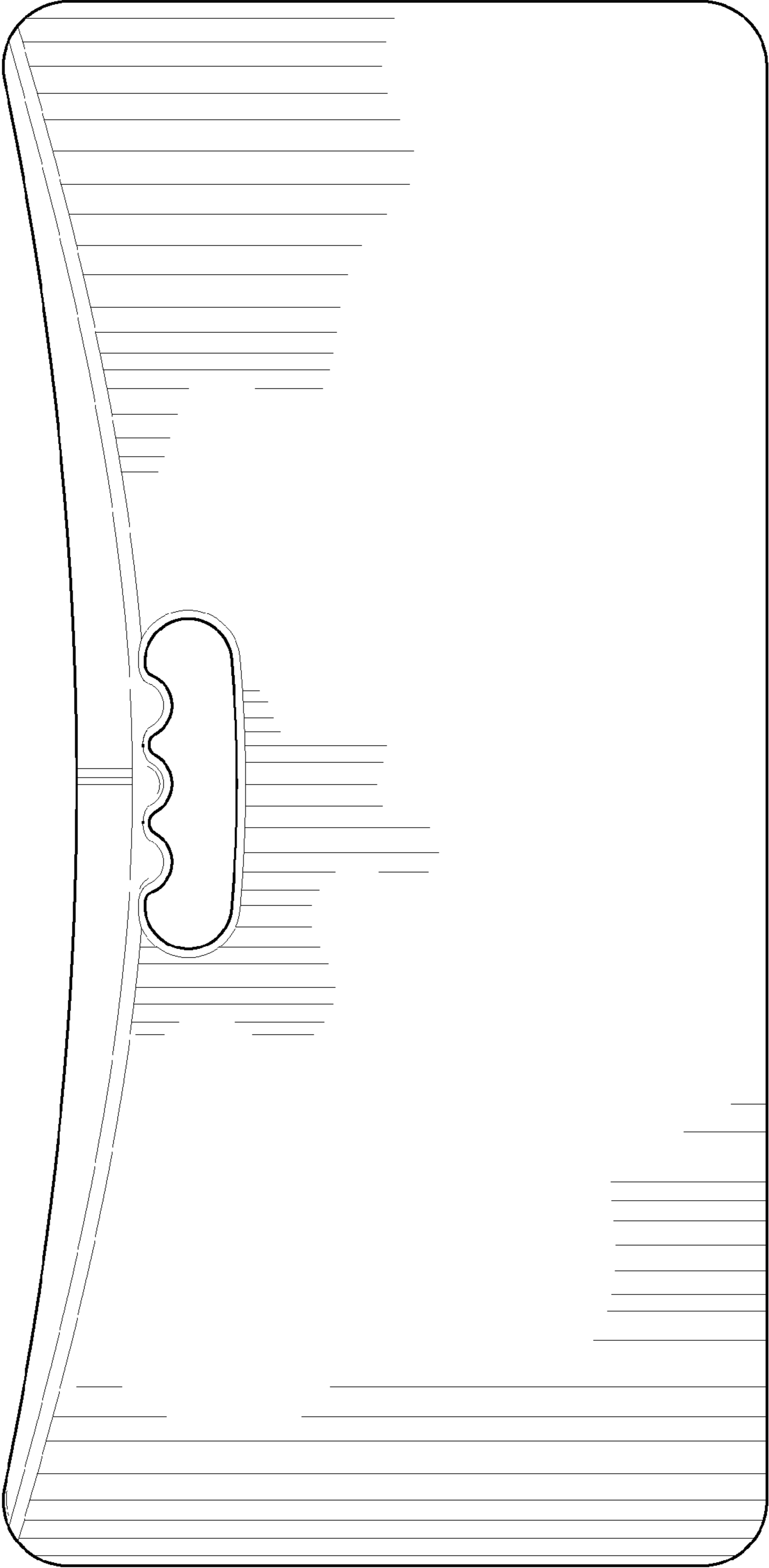

FIG. 4

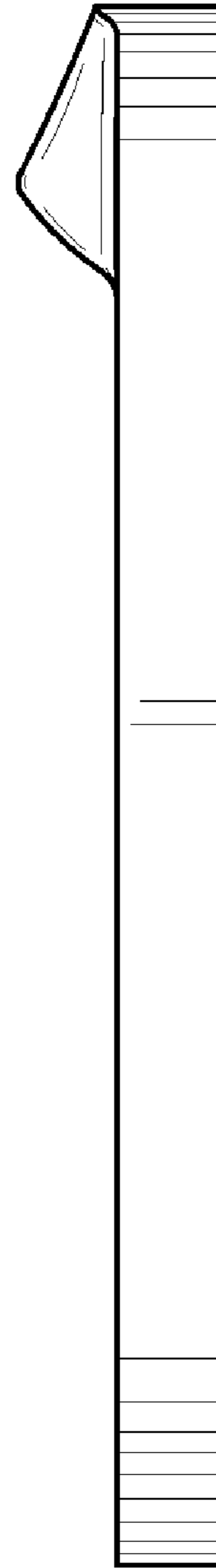

FIG. 5

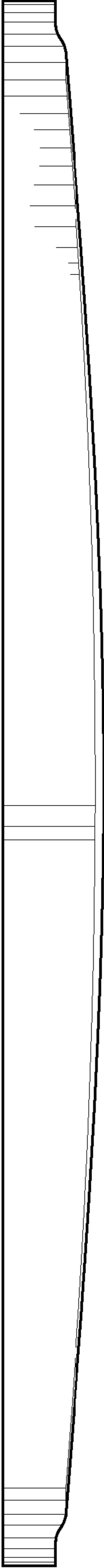
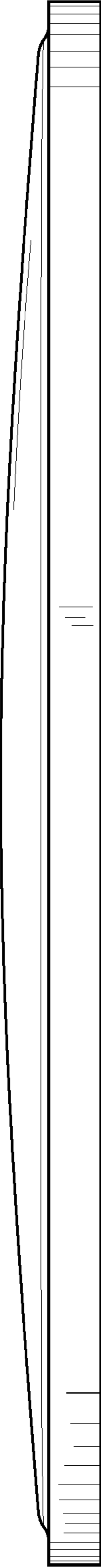

FIG. 6



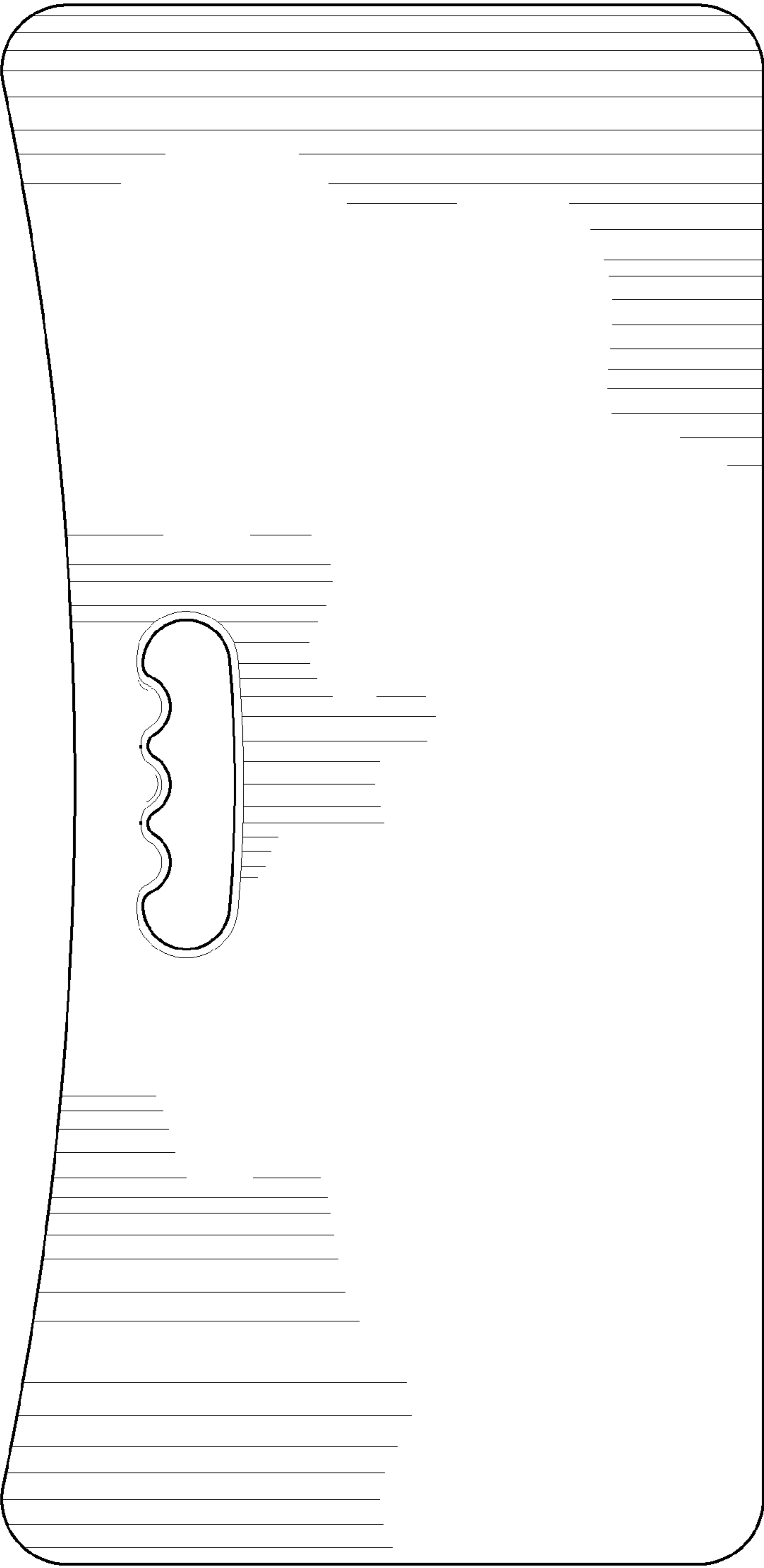

FIG. 7