



US00D630233S

(12) **United States Design Patent**
Ford et al.

(10) **Patent No.:** **US D630,233 S**

(45) **Date of Patent:** **** Jan. 4, 2011**

(54) **DIRECTIONAL BORING BIT**

(76) Inventors: **Douglas R. Ford**, 6663 Valley Dr., Cedar Hill, MO (US) 63016; **Ben Edward Hoffman, III**, 6669 Valley Dr., Cedar Hill, MO (US) 63016

(**) Term: **14 Years**

(21) Appl. No.: **29/365,969**

(22) Filed: **Jul. 16, 2010**

(51) **LOC (9) Cl.** **15-09**

(52) **U.S. Cl.** **D15/123; D15/139**

(58) **Field of Classification Search** D8/70, D8/71; D15/21, 28, 123, 126, 138, 139, D15/140; 175/19, 61, 62, 296, 398, 421; 241/73, 74, 189.1, 193-197, 294, 300
See application file for complete search history.

(56) **References Cited**

U.S. PATENT DOCUMENTS

2,380,112	A *	7/1945	Kinnear	175/336
4,187,626	A *	2/1980	Greer et al.	37/453
4,763,736	A *	8/1988	Varel, Sr.	175/341
4,832,143	A *	5/1989	Kaalstad et al.	175/365
4,848,486	A *	7/1989	Bodine	175/55
5,628,585	A *	5/1997	Parish et al.	405/184.3
5,647,448	A *	7/1997	Skaggs	175/421
5,924,500	A *	7/1999	Puttmann	175/61
6,167,975	B1 *	1/2001	Estes	175/331

6,247,544	B1 *	6/2001	Beebe	175/351
6,308,789	B1 *	10/2001	Kuenzi et al.	175/61
6,321,858	B1 *	11/2001	Wentworth et al.	175/61
6,634,444	B2 *	10/2003	Fuller et al.	175/401
D606,569	S *	12/2009	Ford et al.	D15/139

* cited by examiner

Primary Examiner—Patricia Palasik

(74) *Attorney, Agent, or Firm*—Kevin L. Klug

(57) **CLAIM**

The ornamental design for a directional boring bit, as shown and described.

DESCRIPTION

FIG. 1 is a front top left perspective view of a directional boring bit;

FIG. 2 is a back top left perspective view thereof;

FIG. 3 is a front bottom left perspective view thereof;

FIG. 4 is a back bottom left perspective view thereof;

FIG. 5 is a left side elevation view thereof;

FIG. 6 is a right side elevation view thereof;

FIG. 7 is a front view thereof;

FIG. 8 is a rear view thereof;

FIG. 9 is a top plan view thereof; and,

FIG. 10 is a bottom plan view thereof.

1 Claim, 7 Drawing Sheets

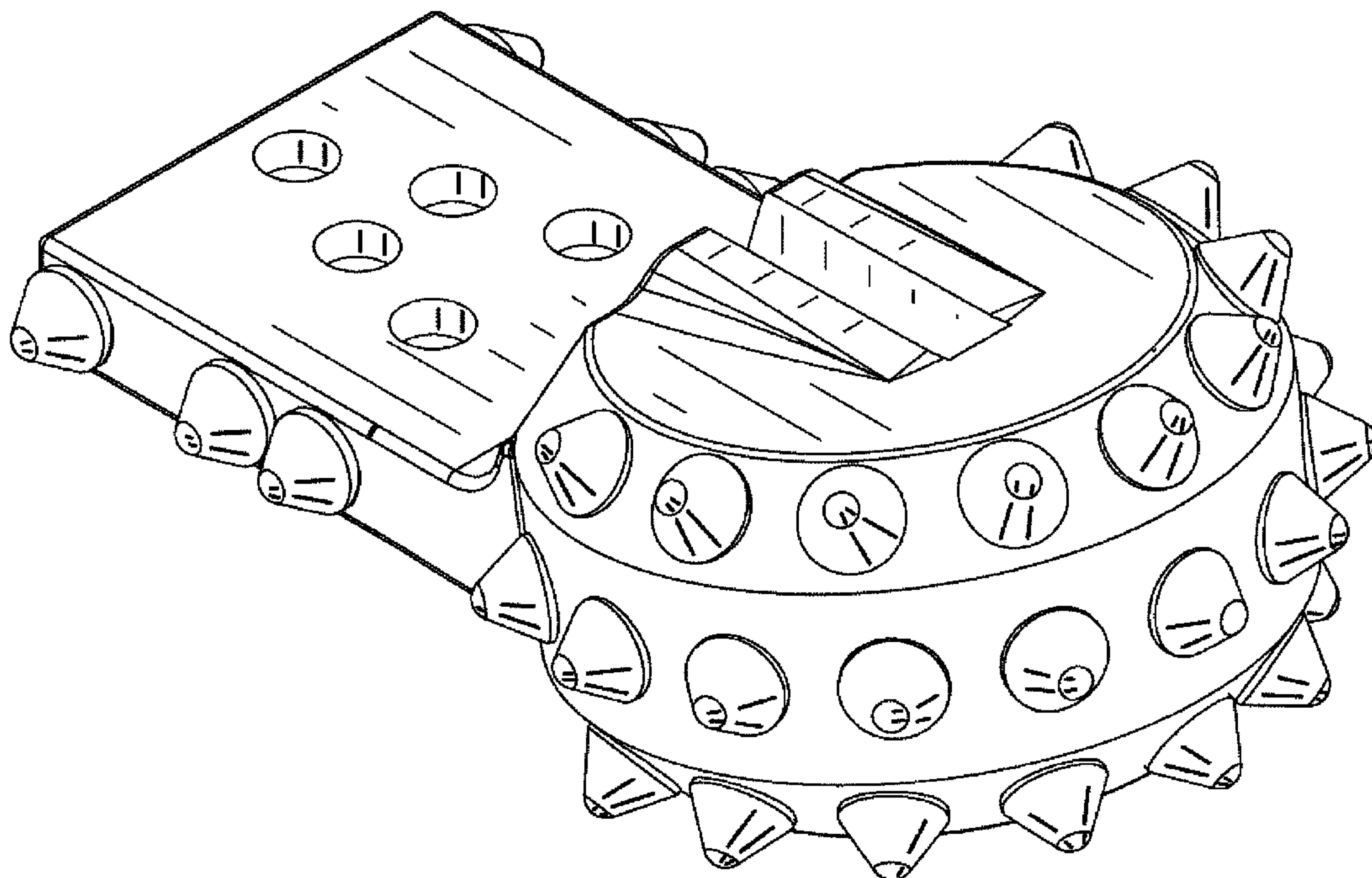

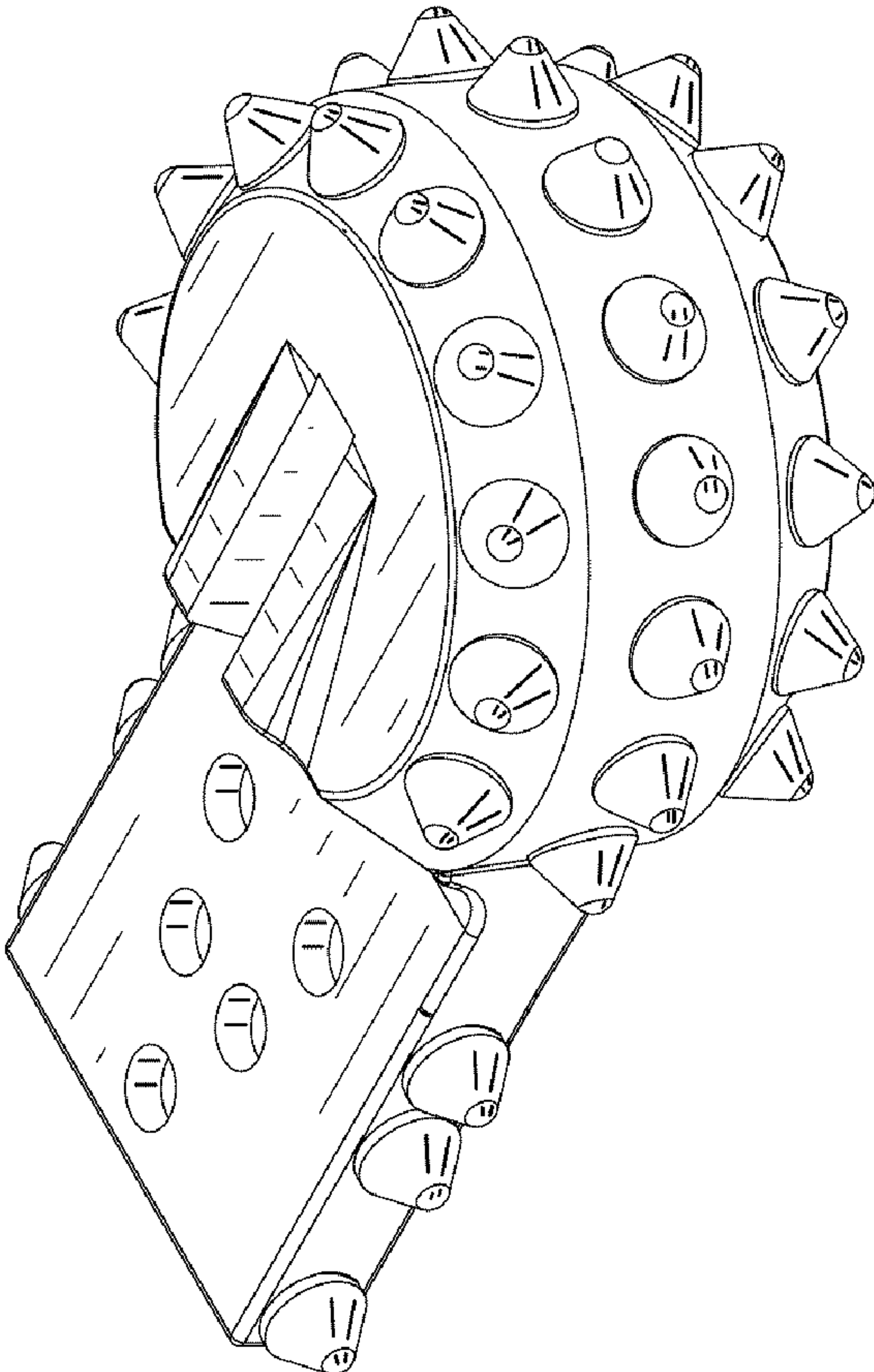

Fig. 1

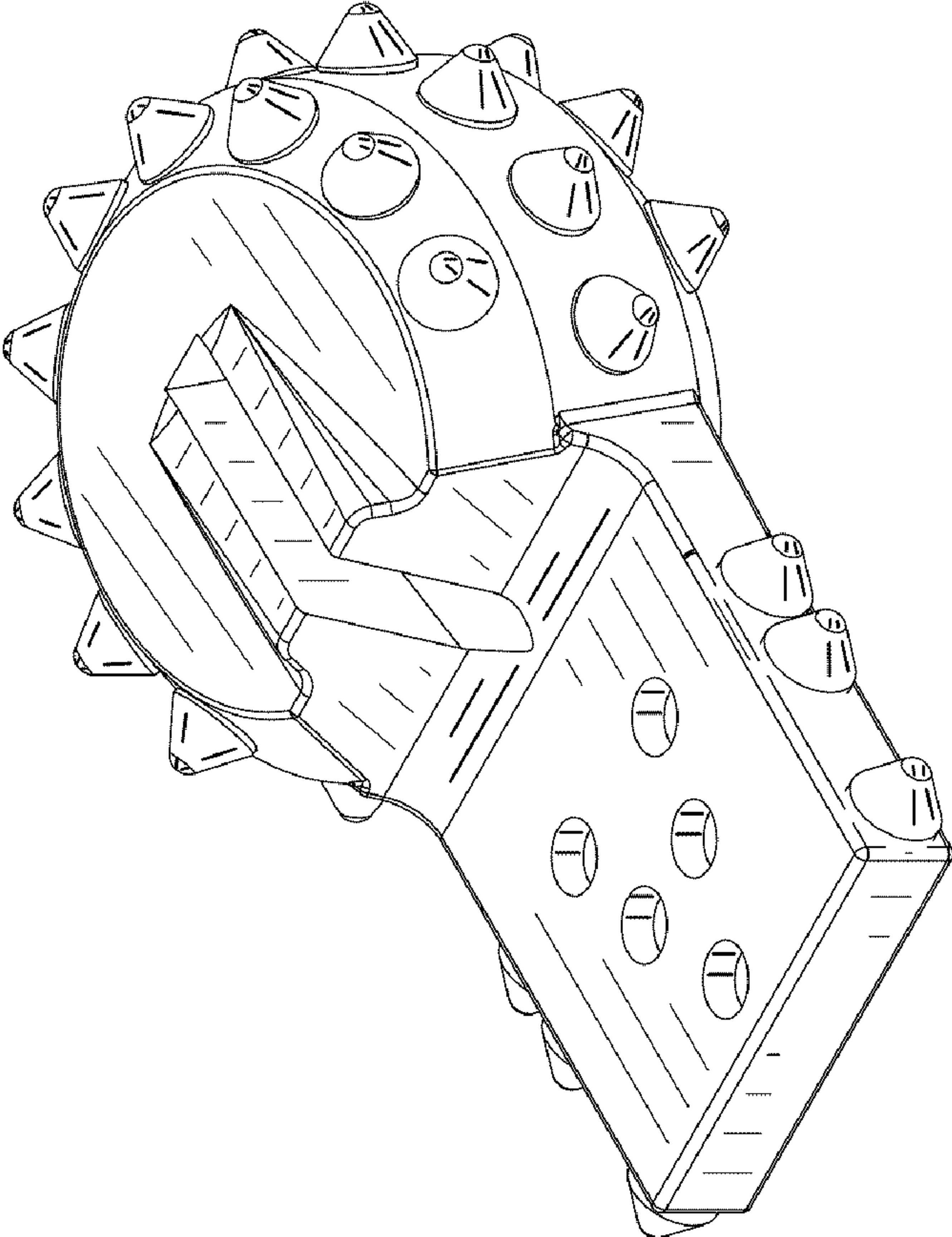

Fig. 2

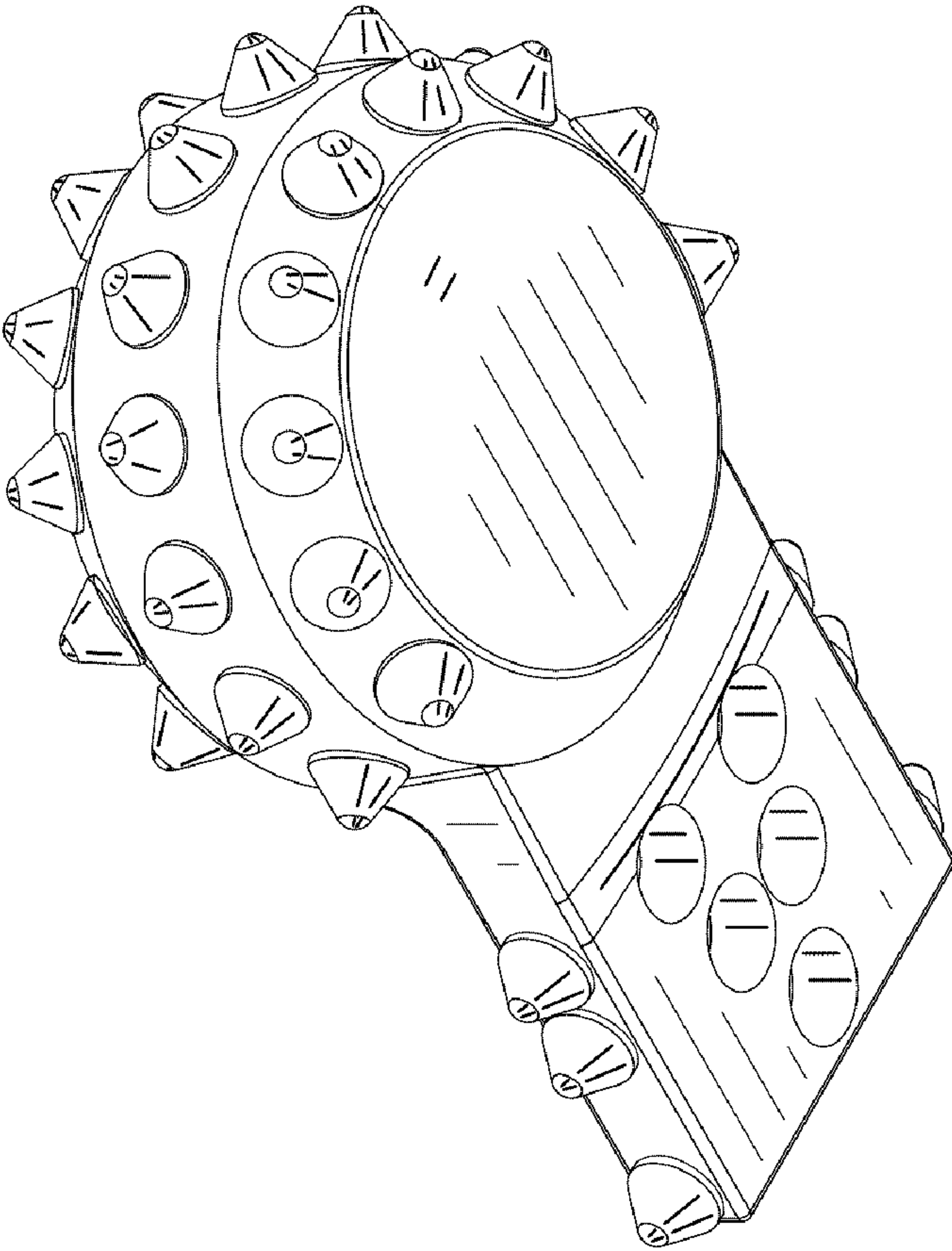

Fig. 3

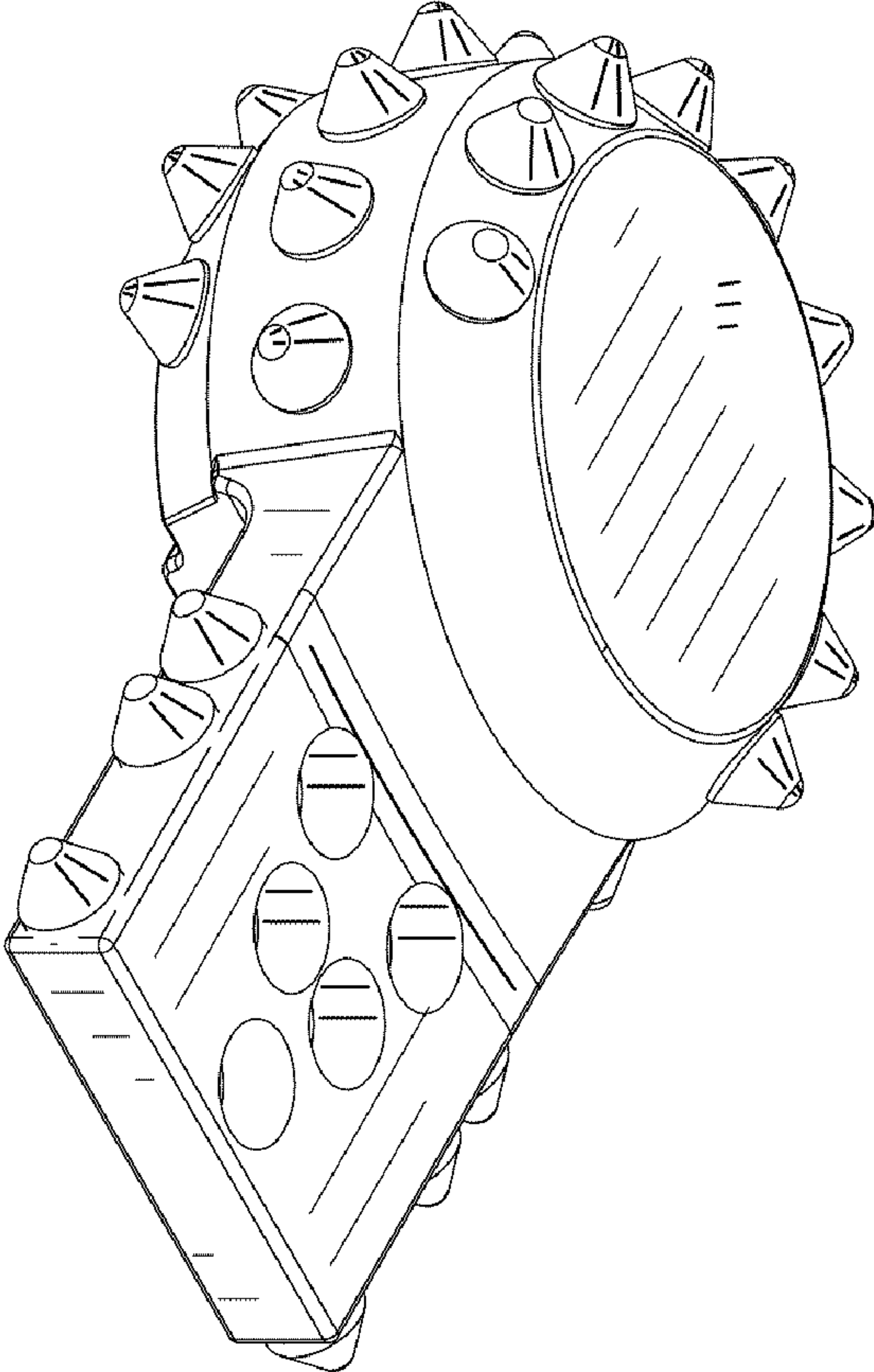

Fig. 4

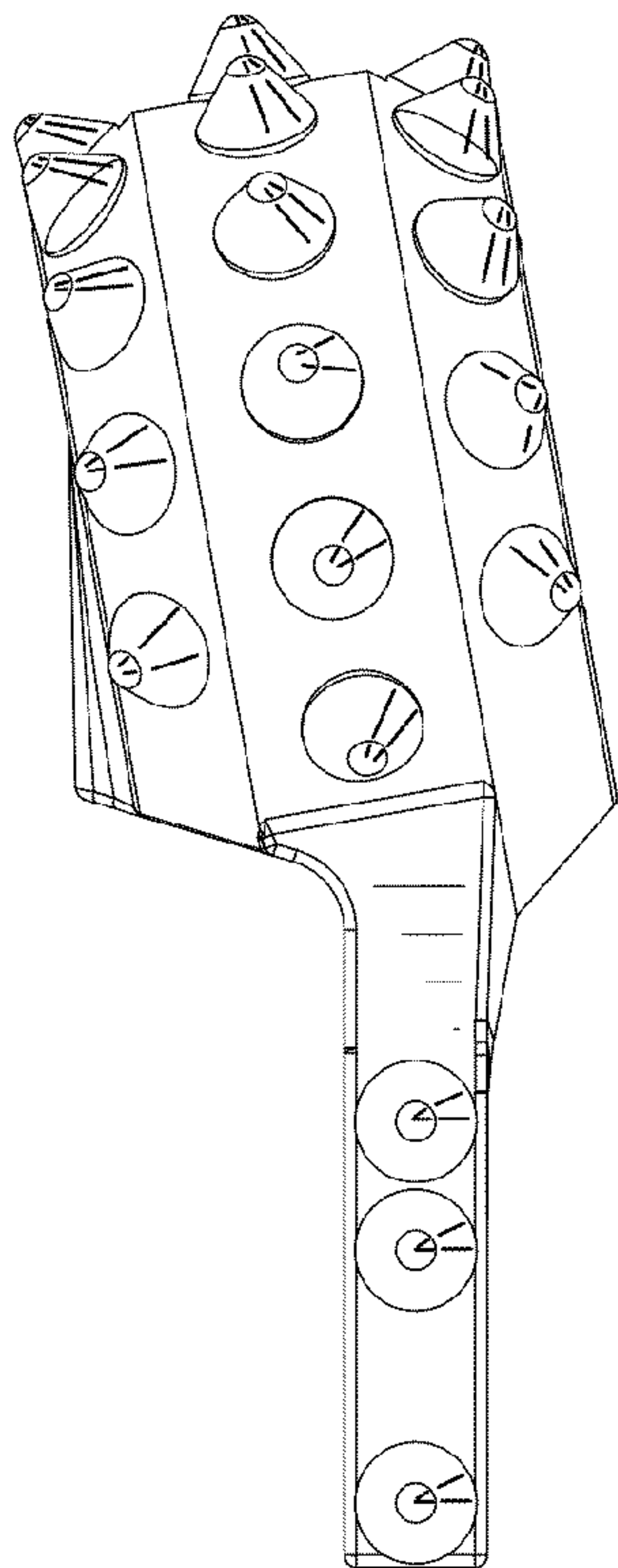

Fig. 5

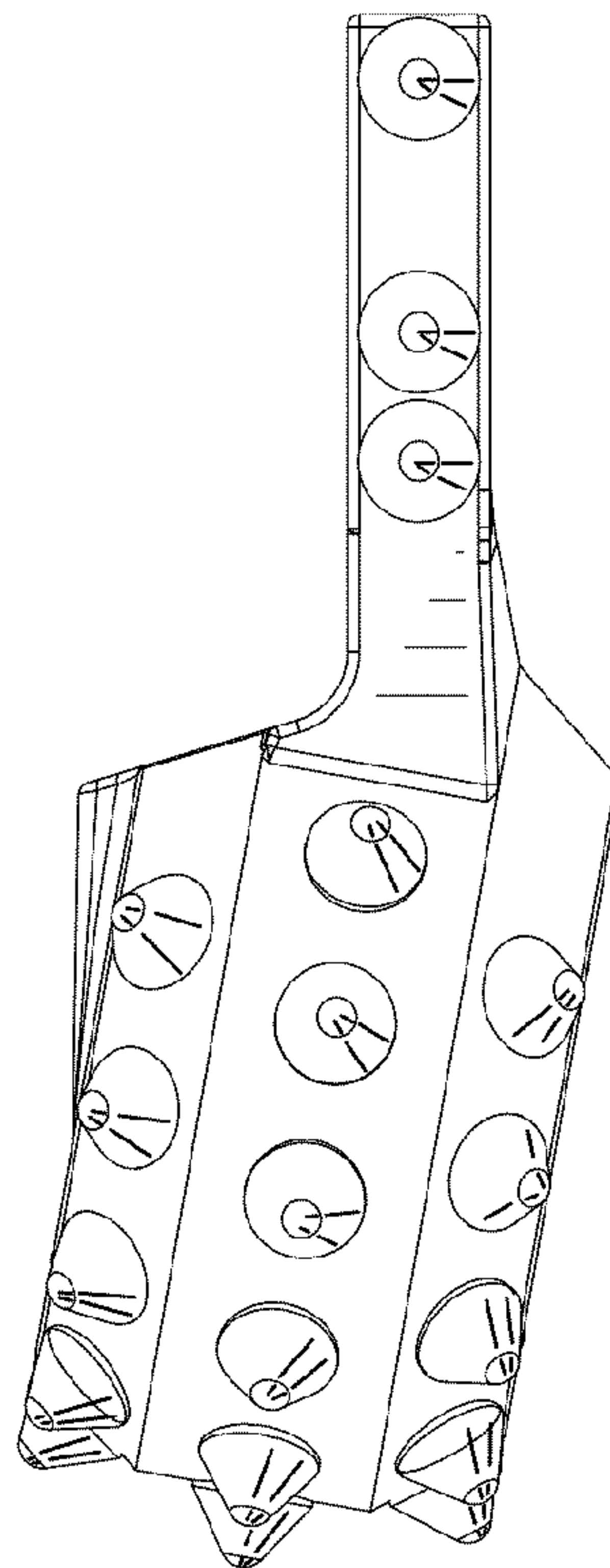

Fig. 6

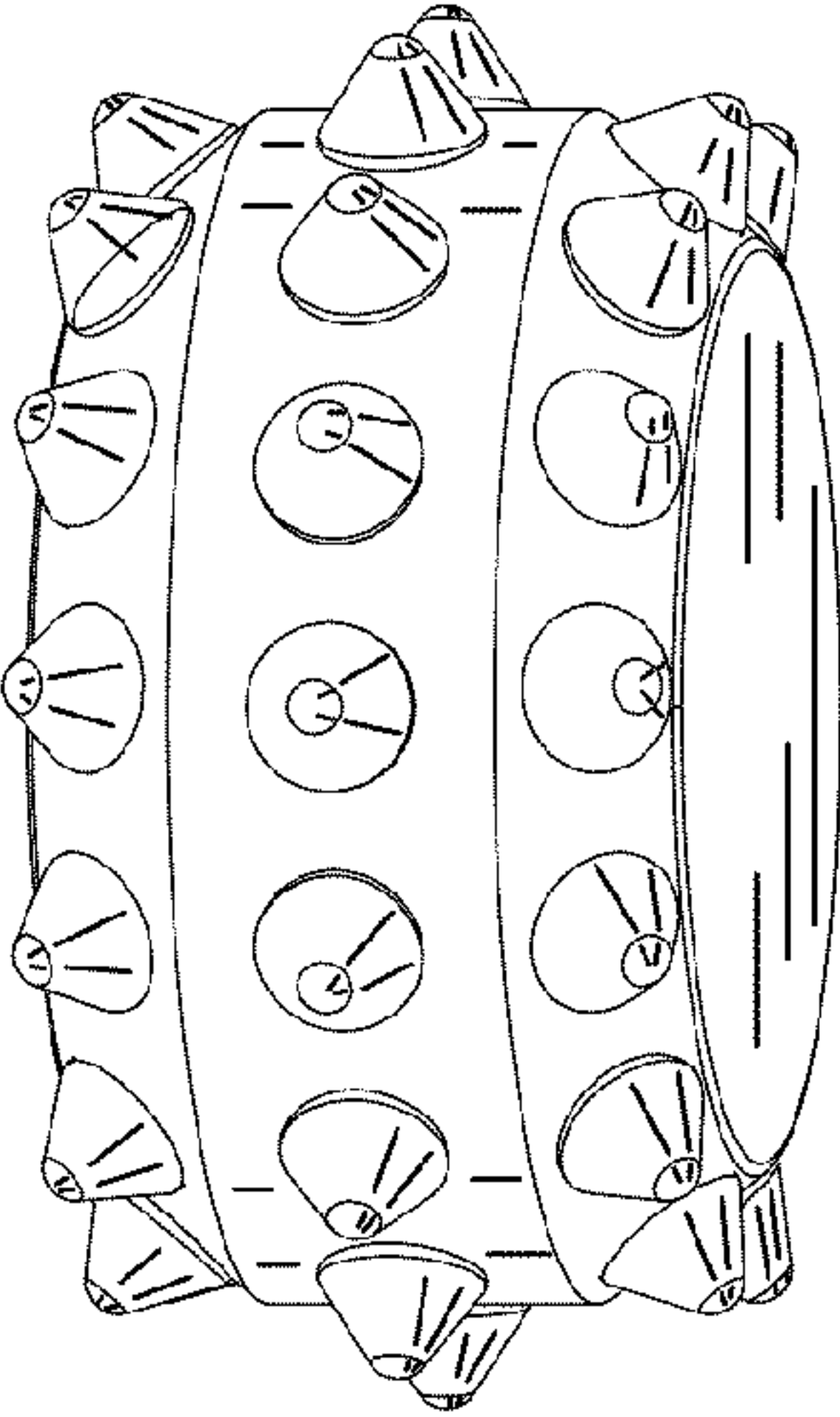

Fig. 7

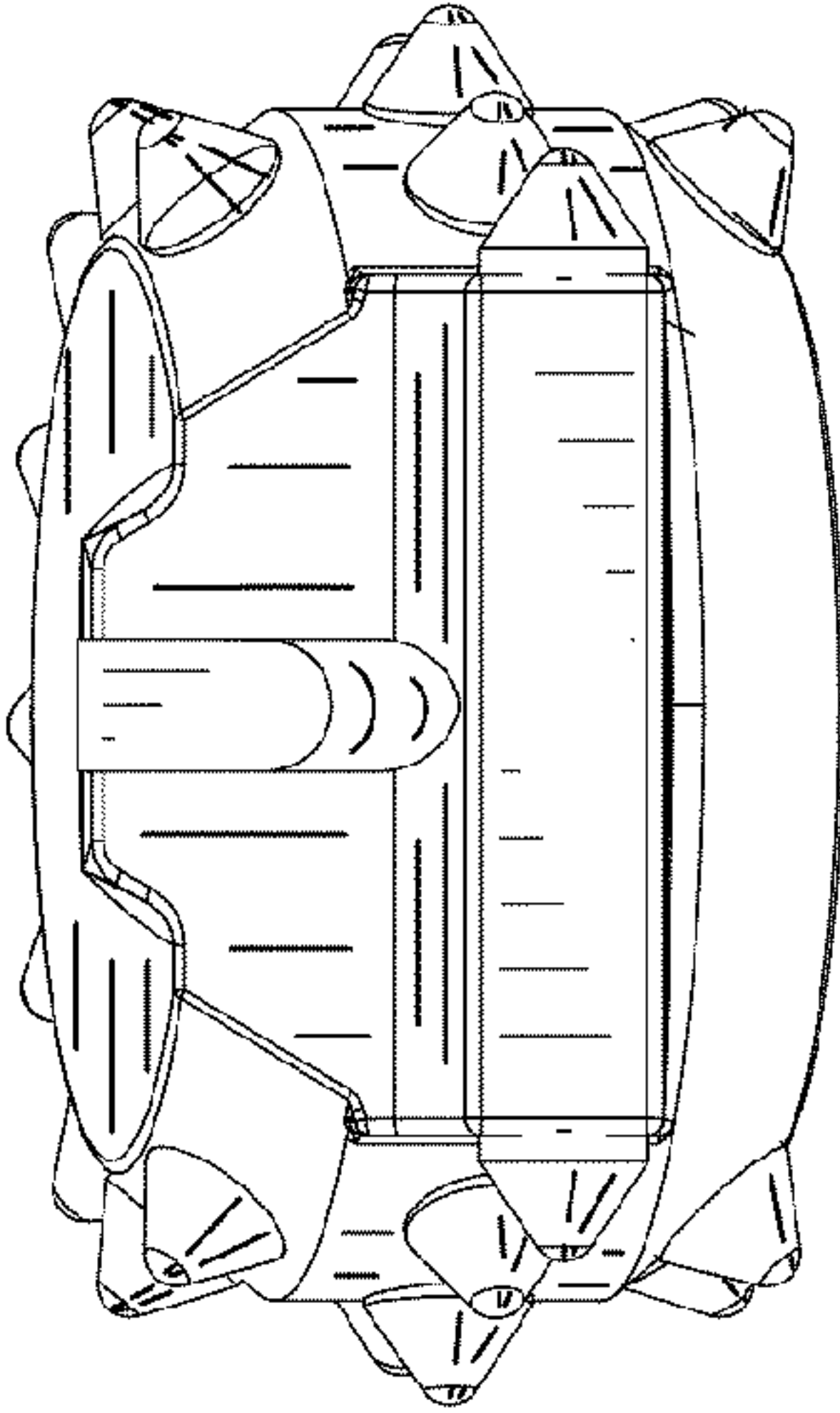

Fig. 8

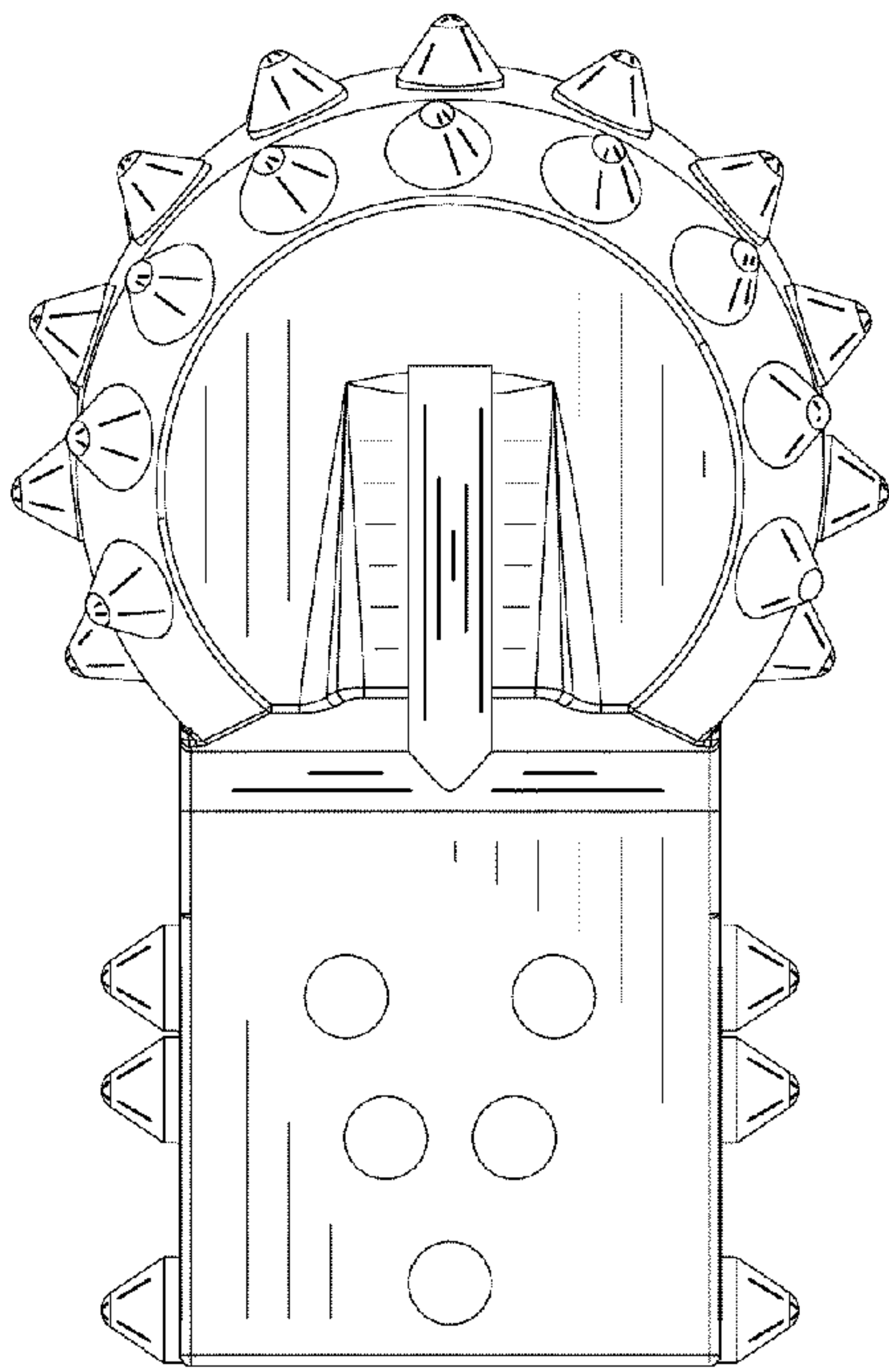

Fig. 9

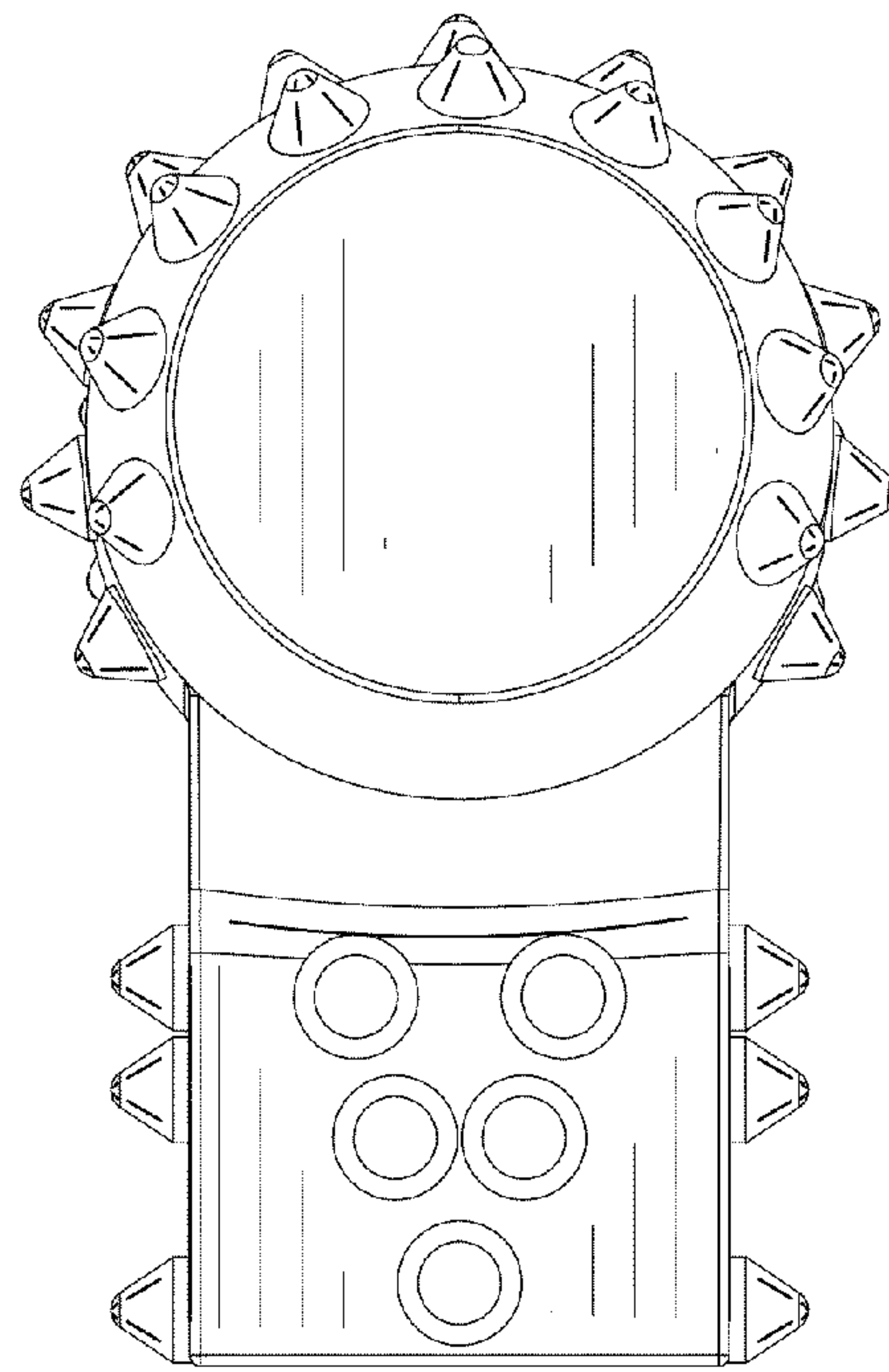

Fig. 10