



US00D630183S

(12) **United States Design Patent**
Park et al.

(10) **Patent No.:** **US D630,183 S**

(45) **Date of Patent:** **** Jan. 4, 2011**

(54) **MOBILE PHONE**

(75) Inventors: **Jun-Sang Park**, Anyang-si (KR);
Sang-Min Hyun, Seoul (KR);
Seog-Guen Kim, Seoul (KR)

(73) Assignee: **Samsung Electronics Co., Ltd.**,
Suwon-Si (KR)

(**) Term: **14 Years**

(21) Appl. No.: **29/363,593**

(22) Filed: **Jun. 11, 2010**

(30) **Foreign Application Priority Data**

Jan. 8, 2010 (KR) 30-2010-0000676

(51) **LOC (9) Cl.** **14-03**

(52) **U.S. Cl.** **D14/138 AA**

(58) **Field of Classification Search** D14/138 AA,
D14/496, 341, 345, 346, 203.3, 203.4, 203.7,
D14/138 AD, 138 R; 455/575.1, 556.2; D21/517;
379/433.01, 433.04

See application file for complete search history.

(56) **References Cited**

U.S. PATENT DOCUMENTS

D492,276 S * 6/2004 Walliser et al. D14/138 AA
D496,921 S * 10/2004 Hwang D14/138 AA
D500,992 S * 1/2005 Shen et al. D14/138 AA
D524,279 S * 7/2006 Lai D14/138 AA
D539,257 S * 3/2007 Obata et al. D14/138 AA
D543,186 S * 5/2007 Kim et al. D14/138 AA
D547,744 S * 7/2007 Kim et al. D14/138 AA
D550,641 S * 9/2007 Wang D14/138 AA
D556,176 S * 11/2007 Kim et al. D14/138 AA
D559,219 S * 1/2008 Suk et al. D14/138 AA

D561,157 S * 2/2008 Bang et al. D14/138 AA
D573,969 S * 7/2008 Tu D14/138 AA
D578,101 S * 10/2008 Park et al. D14/138 AA
D583,350 S * 12/2008 Park et al. D14/138 AA
D597,051 S * 7/2009 Kim et al. D14/138 AA
D601,981 S * 10/2009 Kim et al. D14/138 AA
D601,982 S * 10/2009 Kim et al. D14/138 AA
D609,204 S * 2/2010 Kim et al. D14/138 AA
D609,673 S * 2/2010 Du D14/138 AA

(Continued)

OTHER PUBLICATIONS

Samsung SCH-B100 telephone, announced 1st quarter 2005,
[online], [site visited Aug. 17, 2010]. Available from Internet, <URL:
<http://www.gsmarena.com>>.*

(Continued)

Primary Examiner—Jeffrey D Asch

(74) *Attorney, Agent, or Firm*—Staas & Halsey LLP

(57) **CLAIM**

The ornamental design for a mobile phone, as shown and
described.

DESCRIPTION

FIG. 1 is a front perspective view of a mobile phone;
FIG. 2 is a front view of the mobile phone of FIG. 1;
FIG. 3 is a rear view of the mobile phone of FIG. 1;
FIG. 4 is a left-side view of the mobile phone of FIG. 1;
FIG. 5 is a right-side view of the mobile phone of FIG. 1;
FIG. 6 is a top plan view of the mobile phone of FIG. 1; and,
FIG. 7 is a bottom plan view of the mobile phone of FIG. 1.

1 Claim, 7 Drawing Sheets

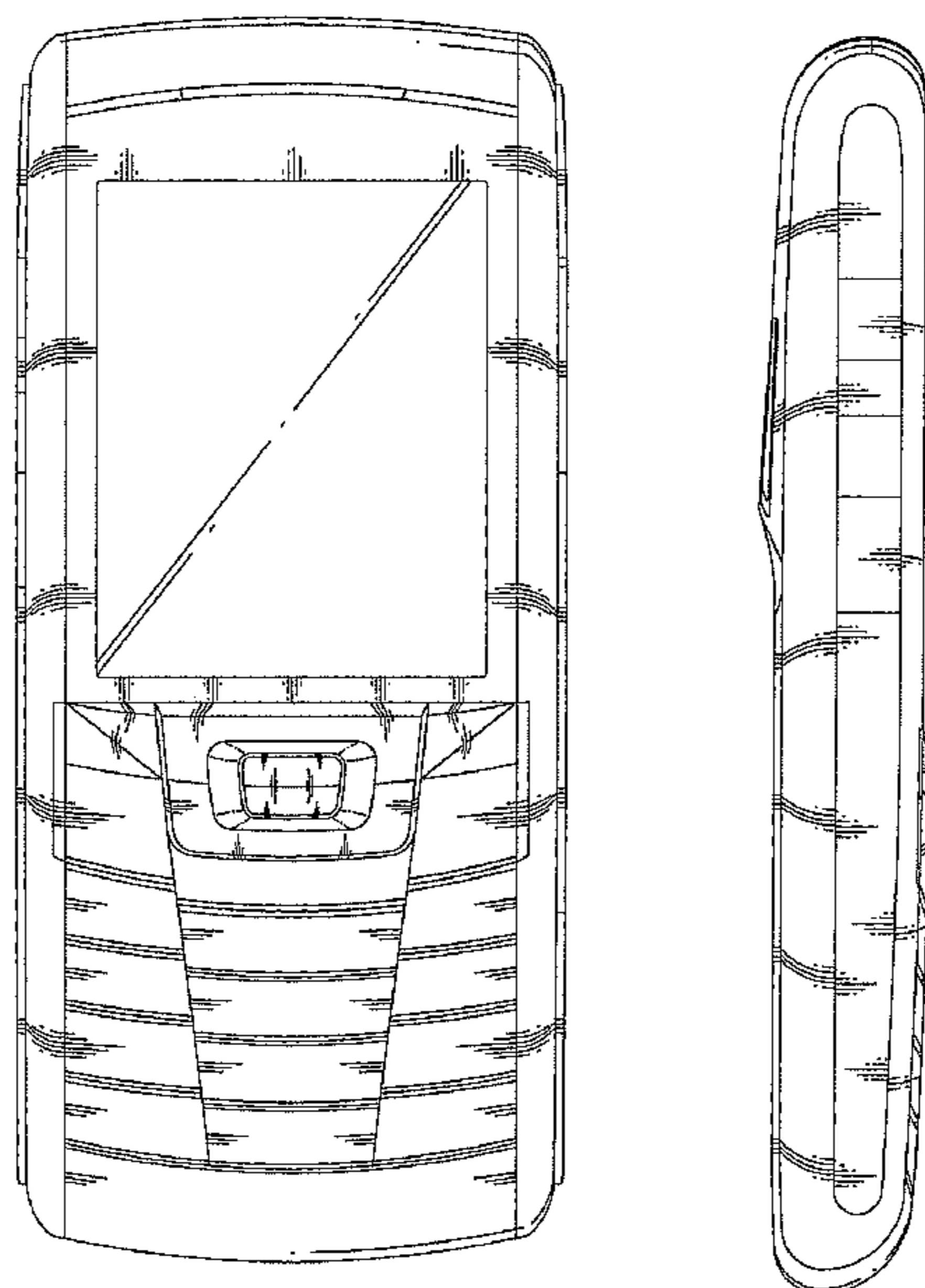

U.S. PATENT DOCUMENTS

D610,113 S * 2/2010 Park et al. D14/138 AA
D610,120 S * 2/2010 Chung et al. D14/138 AA
D610,121 S * 2/2010 Lee et al. D14/138 AA
D610,566 S * 2/2010 Chang D14/138 AA
D615,060 S * 5/2010 Kim et al. D14/138 AA
D615,517 S * 5/2010 Kim et al. D14/138 AA
D615,944 S * 5/2010 Jeong et al. D14/138 AA

OTHER PUBLICATIONS

Samsung B200 telephone, announced Apr. 2008, [online], [site visited Aug. 17, 2010]. Available from Internet, <URL: <http://www.gsmarena.com>>.*

Samsung E200 ECO telephone, announced Aug. 2008, [online], [site visited Aug. 17, 2010]. Available from Internet, <URL: <http://www.gsmarena.com>>.*

Samsung Z370 telephone, announced Aug. 2006, [online], [site visited Aug. 17, 2010]. Available from Internet, <URL: <http://www.gsmarena.com>>.*

Samsung P220 telephone, announced Apr. 2008, [online], [site visited Aug. 17, 2010]. Available from Internet, <URL: <http://www.gsmarena.com>>.*

LG 341i telephone, announced 2nd quarter 2005, [online], [site visited Aug. 17, 2010]. Available from Internet, <URL: <http://www.gsmarena.com>>.*

Bird S699 telephone, announced 3rd quarter 2005, [online], [site visited Aug. 17, 2010]. Available from Internet, <URL: <http://www.gsmarena.com>>.*

* cited by examiner

FIG. 1

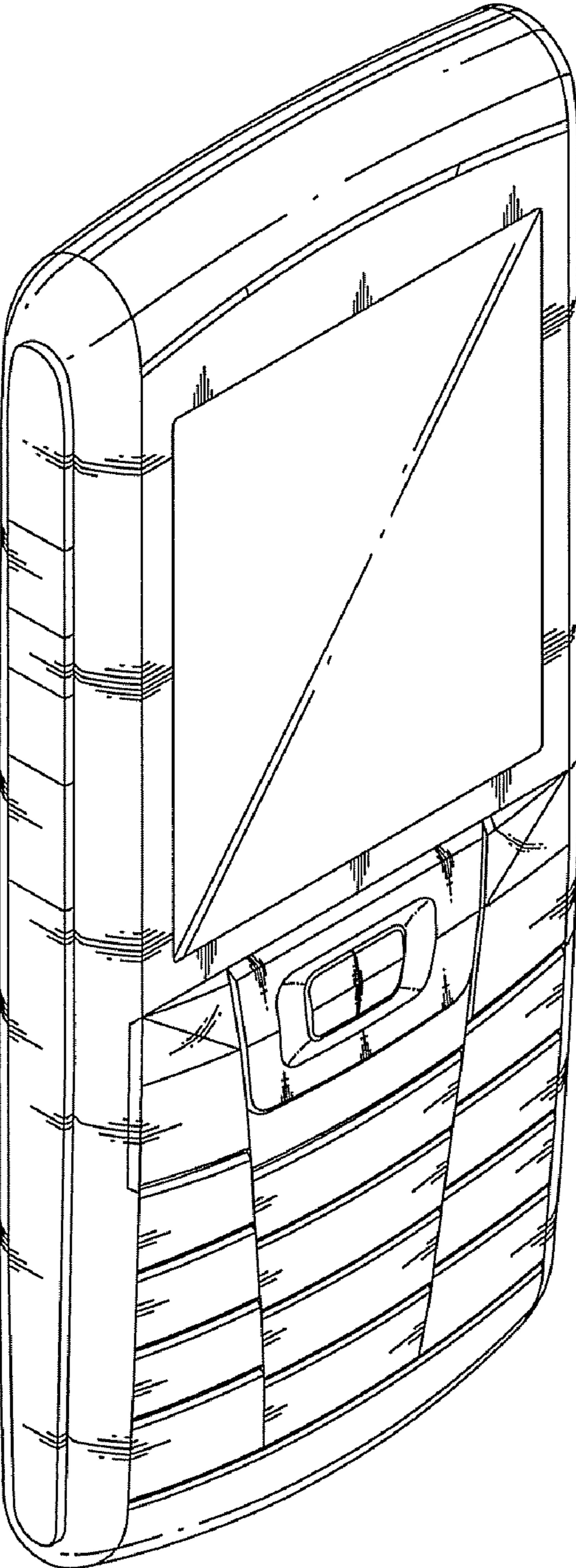

FIG. 2

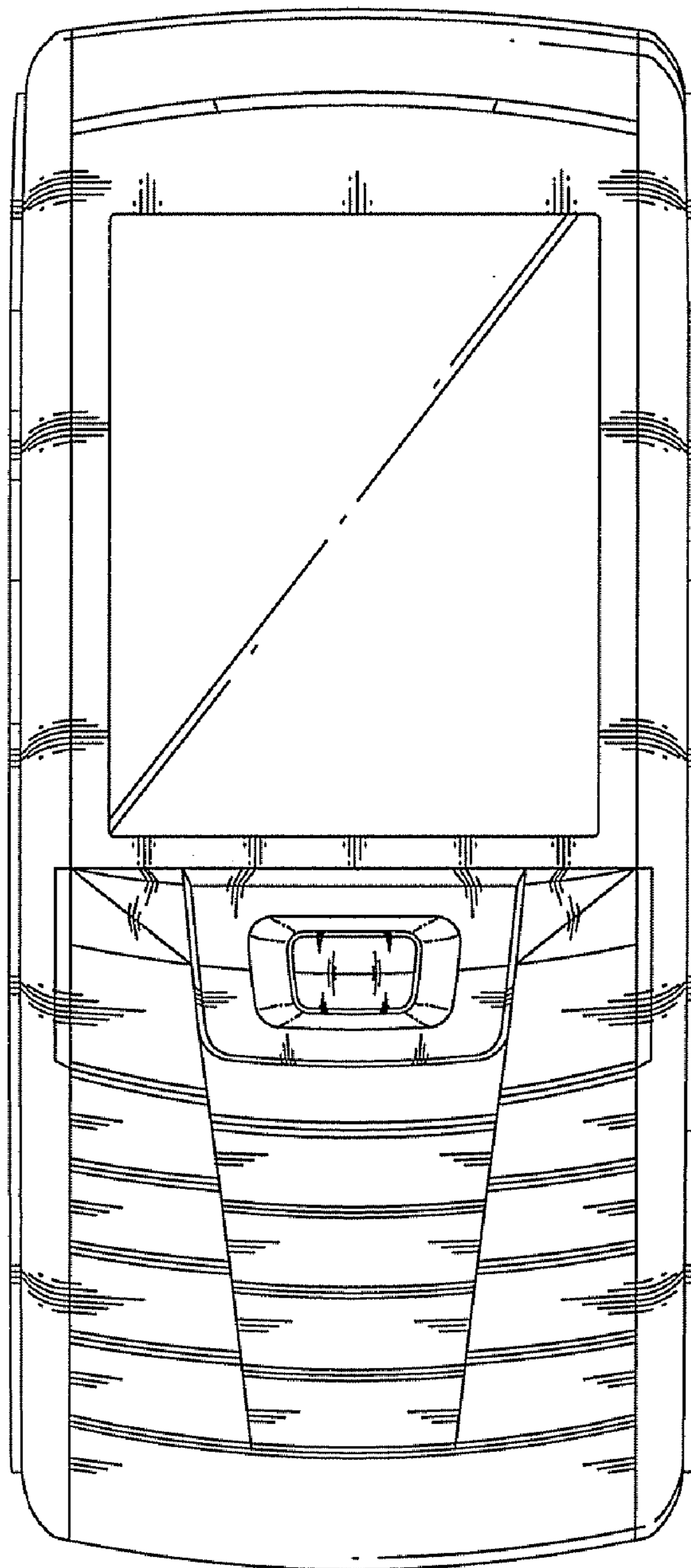

FIG. 3

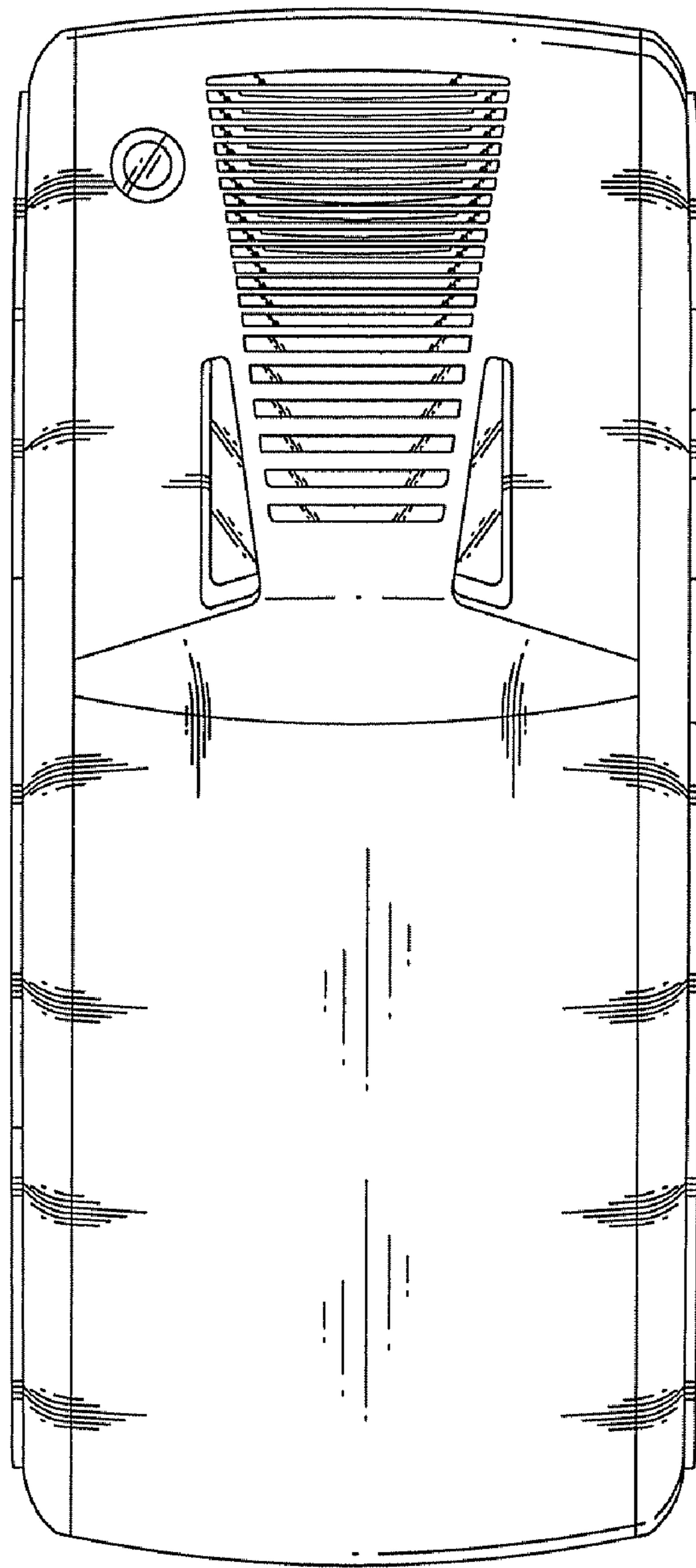

FIG. 4

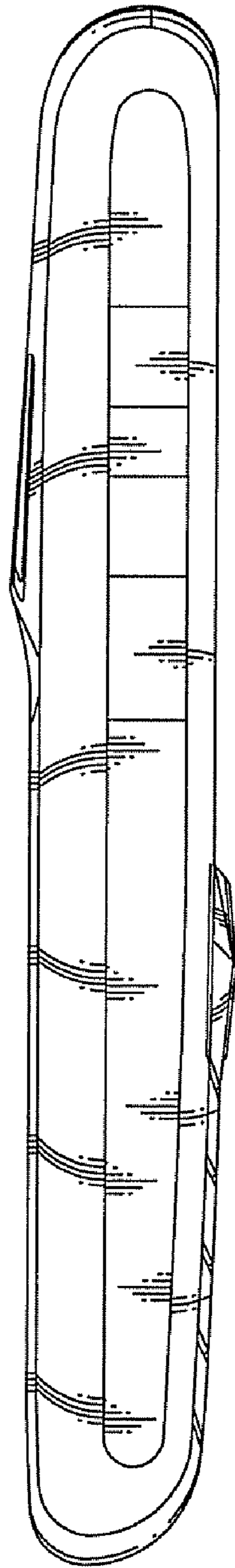

FIG. 5

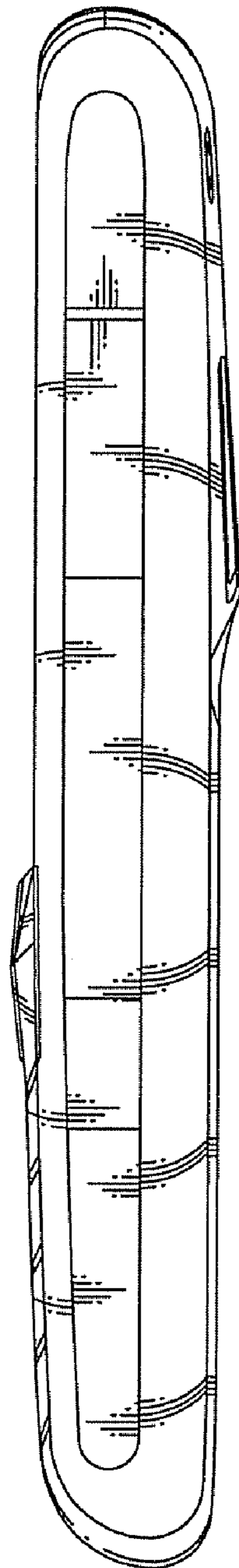

FIG. 6

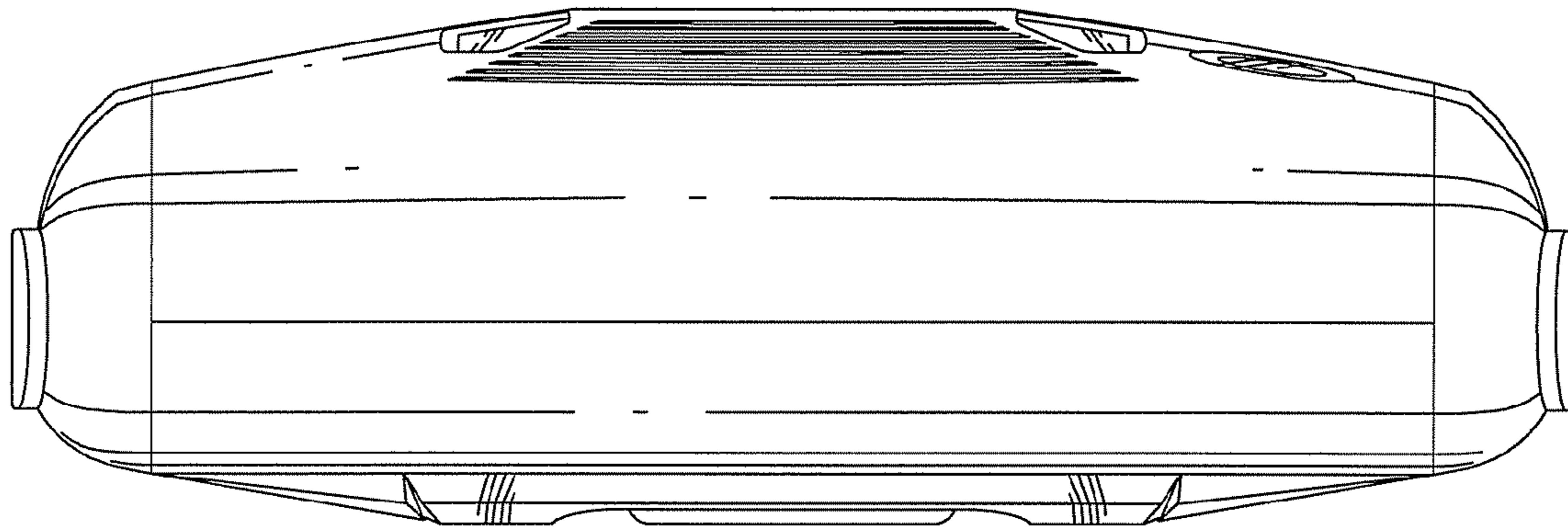

FIG. 7

