



US00D630180S

(12) **United States Design Patent**
Kim et al.

(10) **Patent No.:** **US D630,180 S**
(45) **Date of Patent:** **** Jan. 4, 2011**

(54) **MOBILE PHONE**

(75) Inventors: **Bo-Ra Kim**, Seoul (KR); **Nam-Mi Kim**,
Seoul (KR); **Chang-Hwan Hwang**,
Seongnam-si (KR)

(73) Assignee: **Samsung Electronics Co., Ltd.**,
Suwon-Si (KR)

(**) Term: **14 Years**

(21) Appl. No.: **29/360,505**

(22) Filed: **Apr. 27, 2010**

(30) **Foreign Application Priority Data**

Jan. 5, 2010 (KR) 30-2010-0000212

(51) **LOC (9) Cl.** **14-03**

(52) **U.S. Cl.** **D14/138 AB**

(58) **Field of Classification Search** D14/138 AB,
D14/496, 341, 345, 346, 203.3, 203.4, 203.7;
455/575.3; D21/517; 379/433.13

See application file for complete search history.

(56) **References Cited**

U.S. PATENT DOCUMENTS

- D500,750 S * 1/2005 Arnholt et al. D14/138 AB
- D551,642 S * 9/2007 Kim et al. D14/138 AB
- D554,094 S * 10/2007 Ribeiro et al. D14/138 AB
- D560,189 S * 1/2008 Kim et al. D14/138 AB
- D563,358 S * 3/2008 Baik et al. D14/138 AB
- D571,337 S * 6/2008 Lee et al. D14/138 AB
- D572,225 S * 7/2008 Choi et al. D14/138 AB

- D572,690 S * 7/2008 Kim et al. D14/138 AB
- D578,097 S * 10/2008 Lee et al. D14/138 AB
- D579,893 S * 11/2008 Suk et al. D14/138 AB
- D580,386 S * 11/2008 Cho et al. D14/138 AB

(Continued)

OTHER PUBLICATIONS

Kyocera E3500 telephone, announced Apr. 2008, [online], [site visited Aug. 10, 2010]. Available from Internet ,<URL: <http://www.gsmarena.com>>.*

(Continued)

Primary Examiner—Jeffrey D Asch

(74) *Attorney, Agent, or Firm*—Staas & Halsey LLP

(57) **CLAIM**

The ornamental design for a mobile phone, as shown and described.

DESCRIPTION

FIG. 1 is a front perspective view of a mobile phone;
 FIG. 2 is a front view of the mobile phone of FIG. 1;
 FIG. 3 is a rear view of the mobile phone of FIG. 1;
 FIG. 4 is a left-side view of the mobile phone of FIG. 1;
 FIG. 5 is a right-side view of the mobile phone of FIG. 1;
 FIG. 6 is a top plan view of the mobile phone of FIG. 1;
 FIG. 7 is a bottom plan view of the mobile phone of FIG. 1;
 and,
 FIG. 8 is an open front perspective view of the mobile phone of FIG. 1.

1 Claim, 5 Drawing Sheets

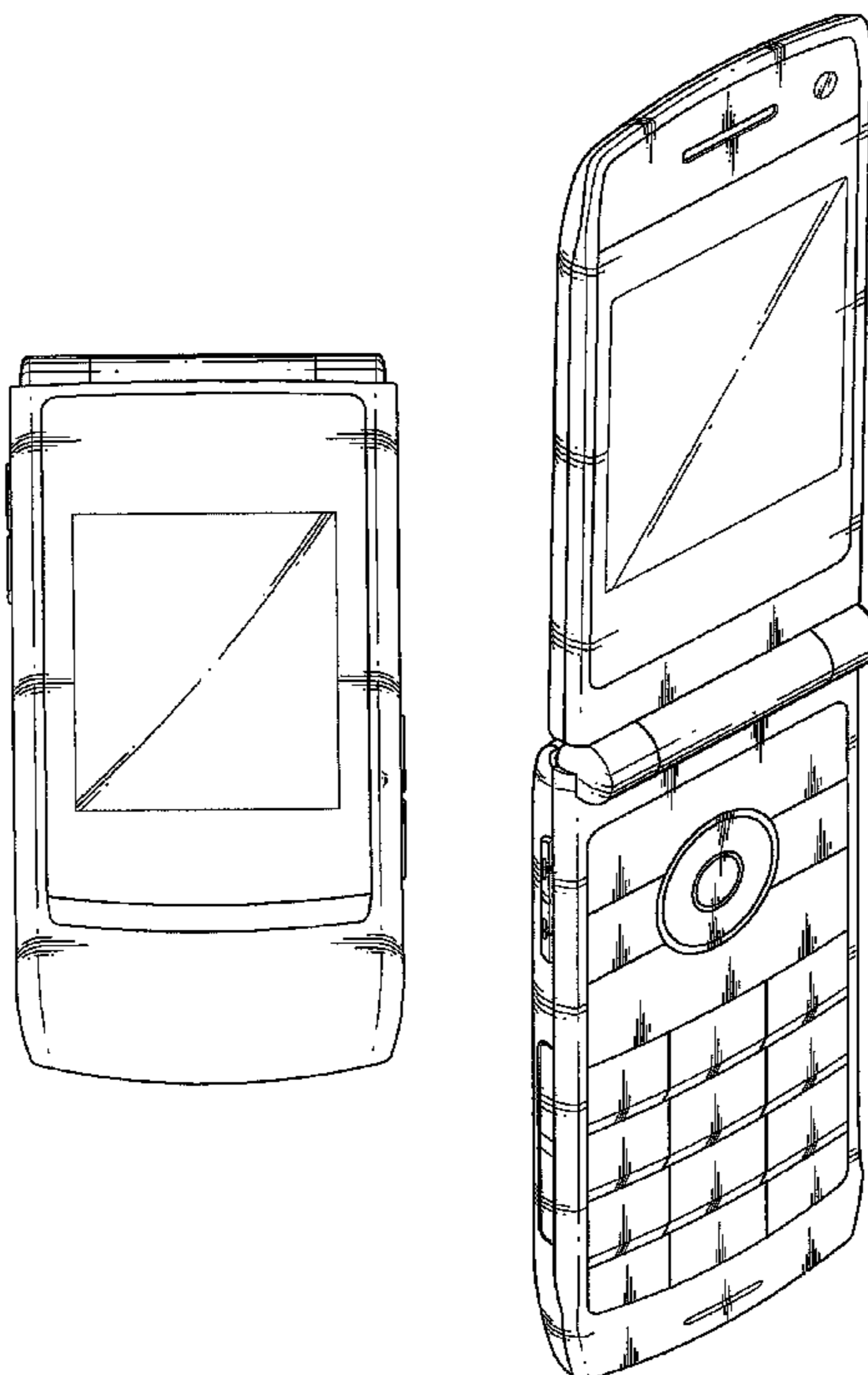

U.S. PATENT DOCUMENTS

D582,884 S * 12/2008 Lee et al. D14/138 AB
 D583,787 S * 12/2008 Kim et al. D14/138 AB
 D583,793 S * 12/2008 Tkachuk D14/138 AB
 D584,276 S * 1/2009 Kim et al. D14/138 AB
 D585,408 S * 1/2009 Kim et al. D14/138 AB
 D585,863 S * 2/2009 Nilsen et al. D14/138 AB
 D587,233 S * 2/2009 Kim et al. D14/138 AB
 D588,086 S * 3/2009 Kim et al. D14/138 AB
 D588,090 S * 3/2009 Nguyen et al. D14/138 AB
 D589,488 S * 3/2009 Kim et al. D14/138 AB
 D589,927 S * 4/2009 Millora et al. D14/138 AB
 D591,719 S * 5/2009 Millora et al. D14/138 AB
 D592,164 S * 5/2009 Han et al. D14/138 AB
 D593,063 S * 5/2009 Millora et al. D14/138 AB
 7,565,182 B2 * 7/2009 Kim 455/575.1
 D603,828 S * 11/2009 Park et al. D14/138 AB
 D605,622 S * 12/2009 Jeon et al. D14/138 AB
 7,751,788 B2 * 7/2010 Otani et al. 455/186.2
 2002/0051060 A1 * 5/2002 Wada 348/207

2006/0111163 A1* 5/2006 Oh 455/575.7

OTHER PUBLICATIONS

Amoi WMA8508 telephone, announced Aug. 2007, [online], [site visited Aug. 10, 2010]. Available from Internet ,<URL: <http://www.gsmarena.com>>.*
 Philips Xenium X700 telephone, announced Apr. 2009, [online], [site visited Aug. 10, 2010]. Available from Internet ,<URL: <http://www.gsmarena.com>>.*
 Sagem my855c telephone, announced Feb. 2008, [online], [site visited Aug. 10, 2010]. Available from Internet ,<URL: <http://www.gsmarena.com>>.*
 Nokia 3610 fold telephone, announced Aug. 2008, [online], [site visited Aug. 10, 2010]. Available from Internet ,<URL: <http://www.gsmarena.com>>.*
 Motorola RAZR2 V8 telephone, announced May 2007, [online], [site visited Aug. 10, 2010]. Available from Internet ,<URL: <http://www.gsmarena.com>>.*

* cited by examiner

FIG. 1

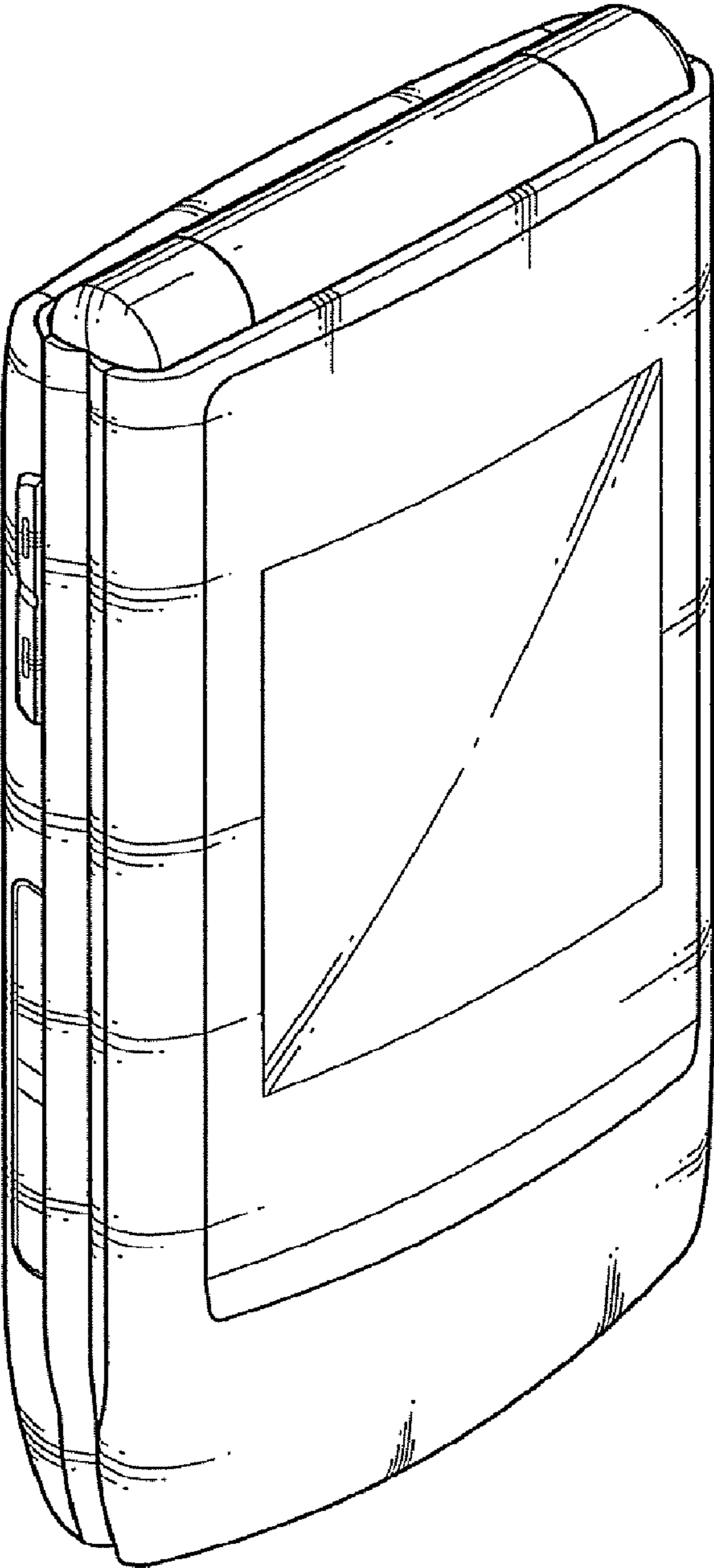

FIG.2

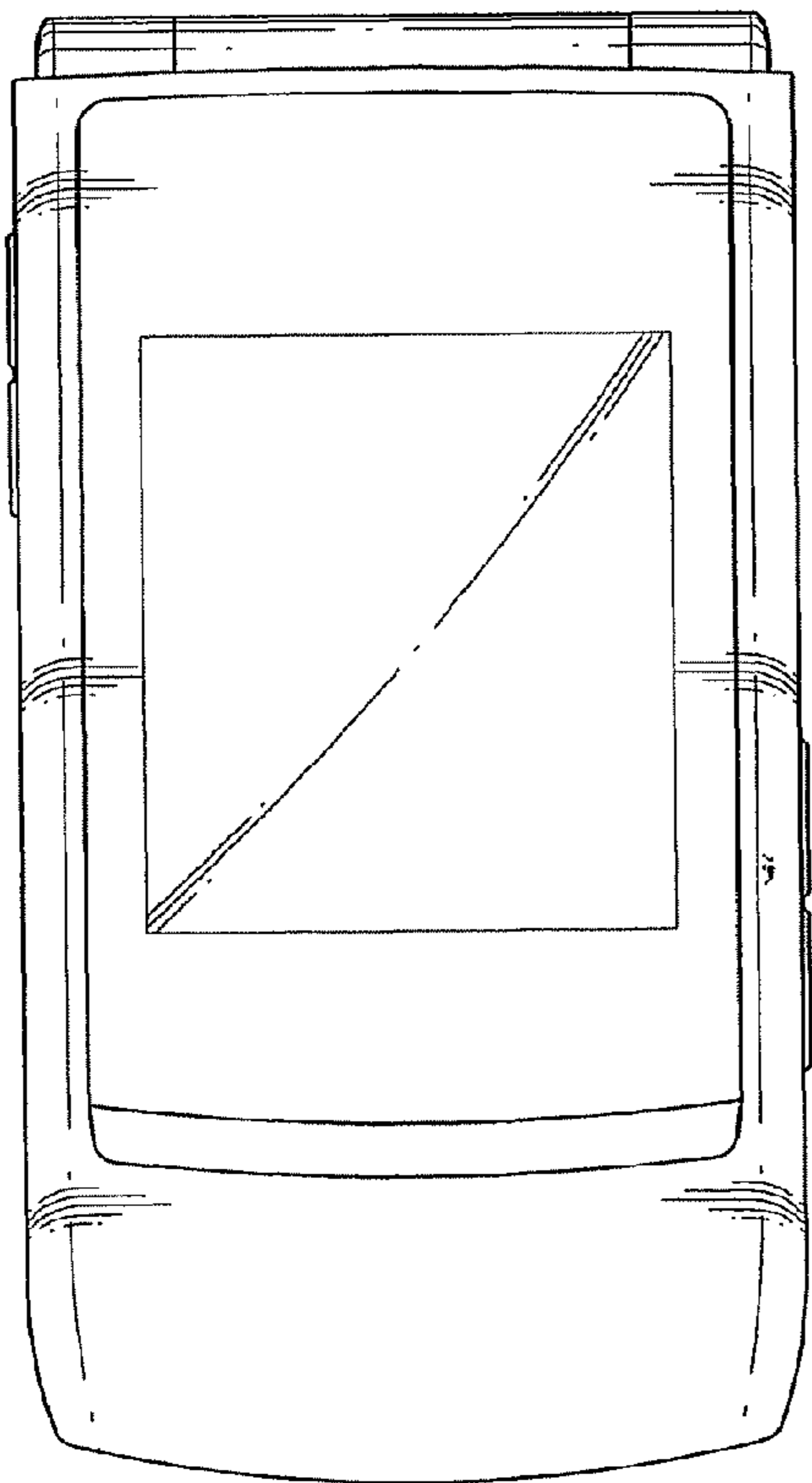

FIG.3

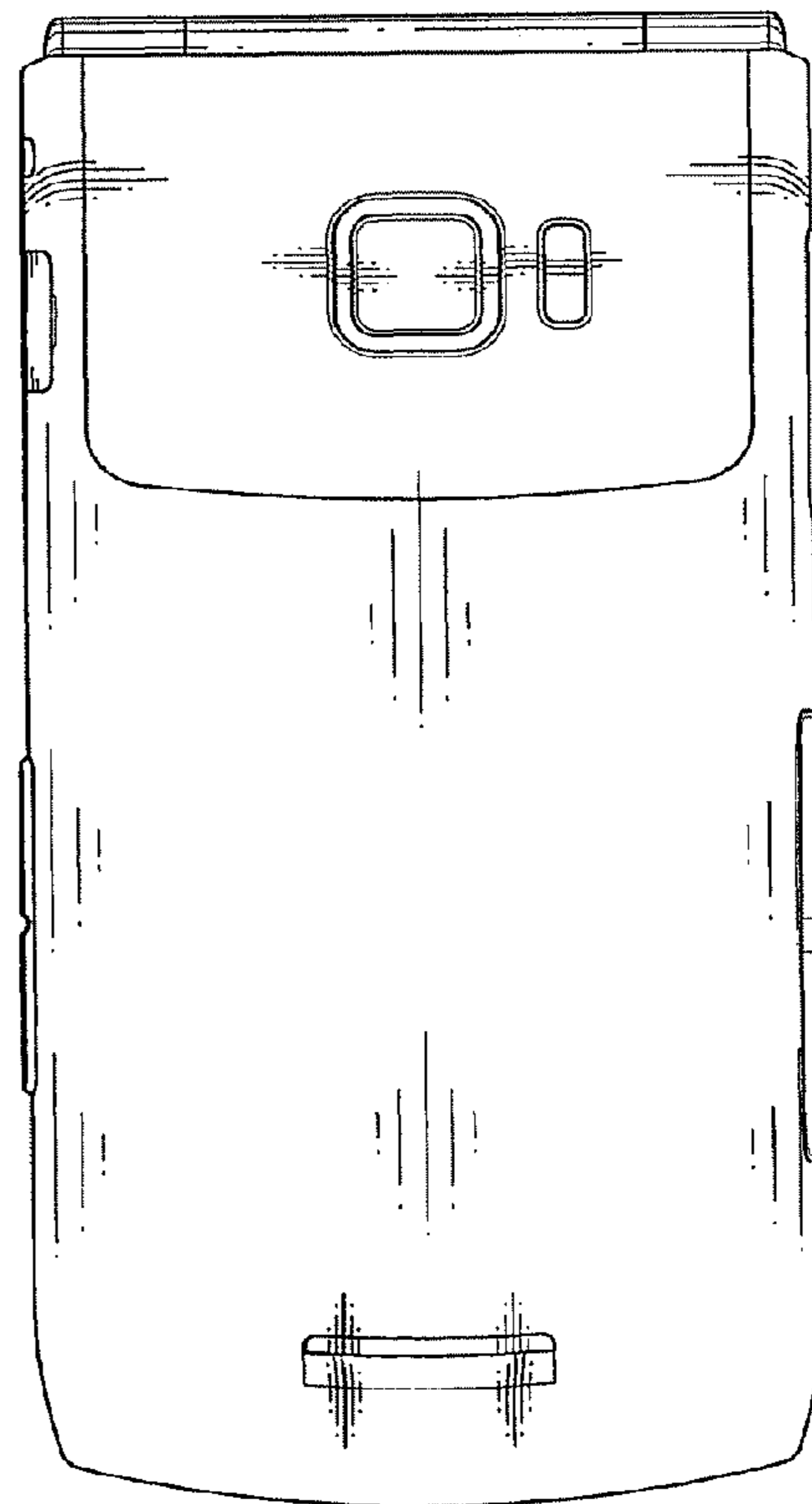

FIG.4

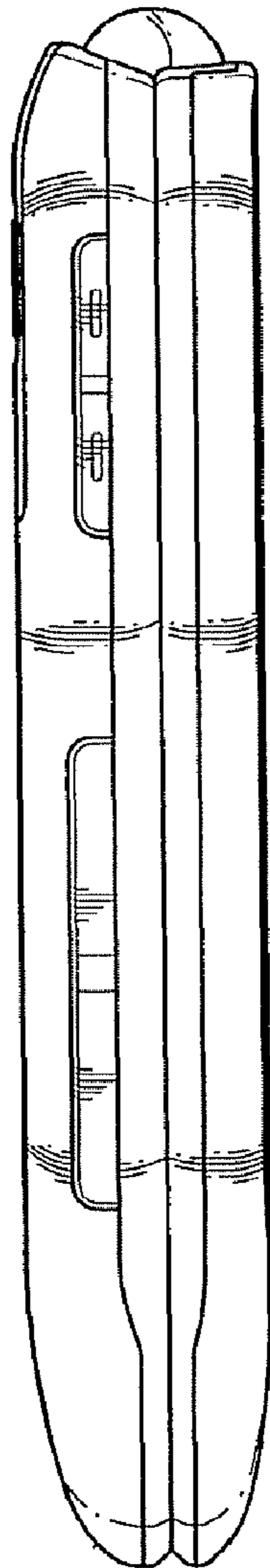

FIG.5

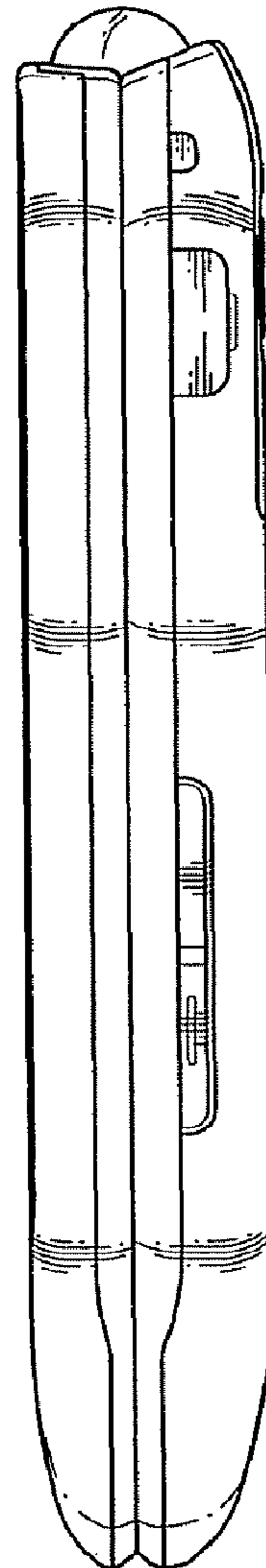

FIG. 6

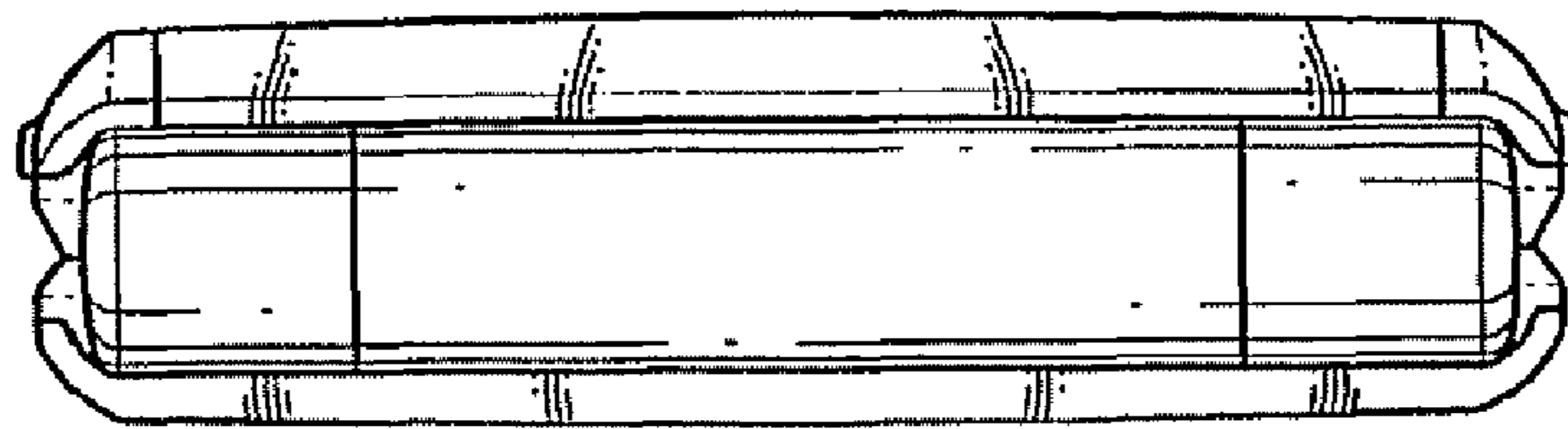

FIG. 7

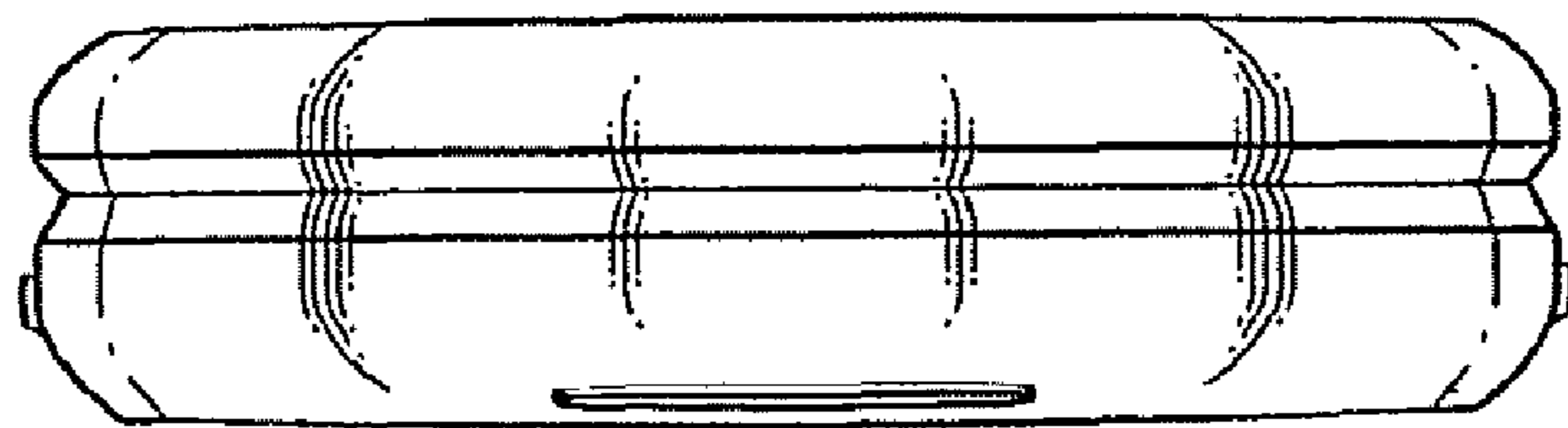

FIG. 8

