



US00D630176S

(12) **United States Design Patent**
Kim et al.

(10) **Patent No.:** **US D630,176 S**
(45) **Date of Patent:** **** Jan. 4, 2011**

(54) **MOBILE PHONE**

(75) Inventors: **Jun Kim**, Uijeongbu-si (KR);
Young-Keun Lee, Seoul (KR);
Chang-Hwan Hwang, Goyang-si (KR)

(73) Assignee: **Samsung Electronics Co., Ltd.**,
Suwon-Si (KR)

(**) Term: **14 Years**

(21) Appl. No.: **29/340,304**

(22) Filed: **Jul. 16, 2009**

(30) **Foreign Application Priority Data**

May 20, 2009 (KR) 30-2009-0021714

(51) **LOC (9) Cl.** **14-03**

(52) **U.S. Cl.** **D14/138 AB**

(58) **Field of Classification Search** D14/138 AB,
D14/496, 341, 345, 346, 203.3, 203.4, 203.7;
455/575.3; D21/517; 379/433.13

See application file for complete search history.

(56) **References Cited**

U.S. PATENT DOCUMENTS

D509,816	S	*	9/2005	Kim et al.	D14/138 AB
D561,719	S	*	2/2008	Cho	D14/138 AB
D569,361	S	*	5/2008	Park	D14/138 AB
D571,772	S	*	6/2008	Kim et al.	D14/138 AB
D573,126	S	*	7/2008	Lee et al.	D14/138 AB
D576,142	S	*	9/2008	Park et al.	D14/138 AB
D584,267	S	*	1/2009	Kim et al.	D14/138 AB
D586,325	S	*	2/2009	Park et al.	D14/138 AB
D587,673	S	*	3/2009	Kim et al.	D14/138 AB
D591,715	S	*	5/2009	Lee et al.	D14/138 AB
D593,050	S	*	5/2009	Kim et al.	D14/138 R
D593,985	S	*	6/2009	Park et al.	D14/138 AB
D598,881	S	*	8/2009	Park et al.	D14/138 AB

D599,765	S	*	9/2009	Park et al.	D14/138 AB
D601,986	S	*	10/2009	Hong et al.	D14/138 AB
D604,262	S	*	11/2009	Lee	D14/138 AB
D613,705	S	*	4/2010	Cha et al.	D14/138 AB
D613,712	S	*	4/2010	Youn et al.	D14/138 AB
D613,714	S	*	4/2010	Park et al.	D14/138 AB
D615,518	S	*	5/2010	Ryu	D14/138 AB

OTHER PUBLICATIONS

Samsung M310 telephone, announced May 2008, [online], [site visited Aug. 10, 2010]. Available from Internet ,<URL: <http://www.gsmarena.com>>.*

Samsung E1150 telephone, announced Feb. 2010, [online], [site visited Aug. 10, 2010]. Available from Internet ,<URL: <http://www.gsmarena.com>>.*

* cited by examiner

Primary Examiner—Jeffrey D Asch

(74) *Attorney, Agent, or Firm*—Staas & Halsey LLP

(57) **CLAIM**

The ornamental design for a mobile phone, as shown and described.

DESCRIPTION

FIG. 1 is a front perspective view of a mobile phone;

FIG. 2 is a front view of the mobile phone of FIG. 1;

FIG. 3 is a rear view of the mobile phone of FIG. 1;

FIG. 4 is a left-side view of the mobile phone of FIG. 1;

FIG. 5 is a right-side view of the mobile phone of FIG. 1;

FIG. 6 is a top plan view of the mobile phone of FIG. 1; and,

FIG. 7 is a bottom plan view of the mobile phone of FIG. 1;

and,

FIG. 8 is a front perspective open view of the mobile phone of FIG. 1.

1 Claim, 5 Drawing Sheets

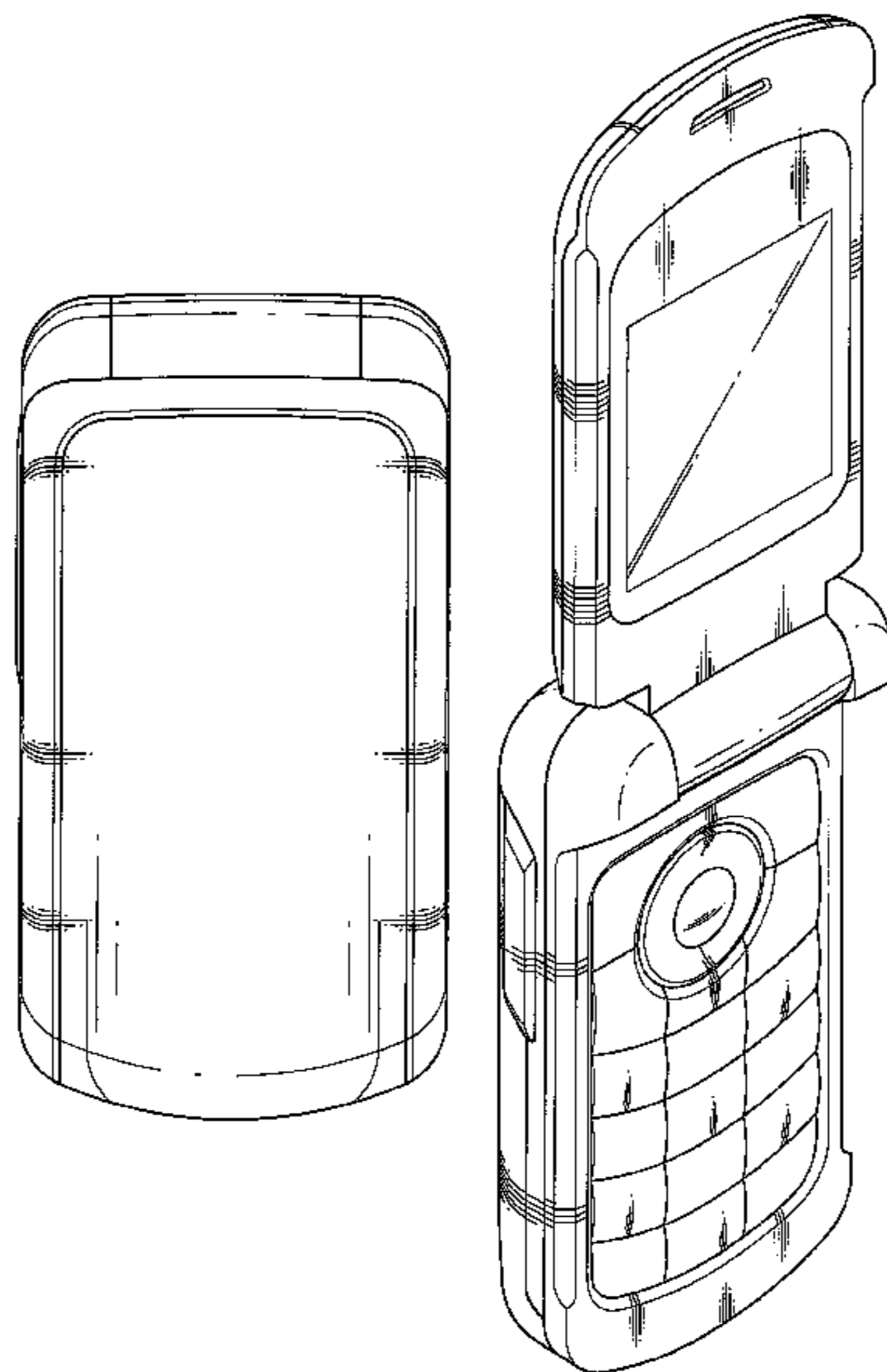

FIG. 1

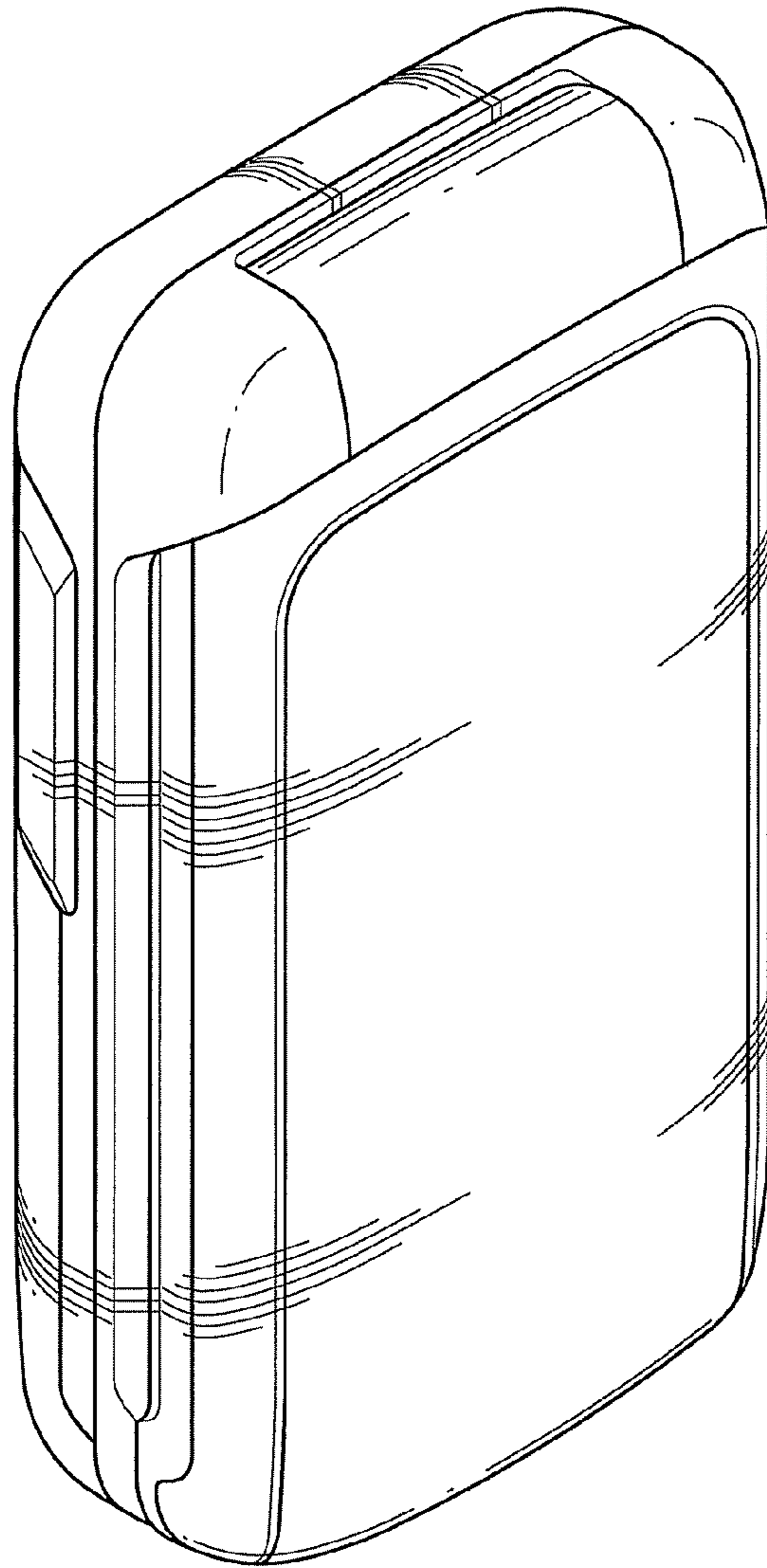

FIG. 2

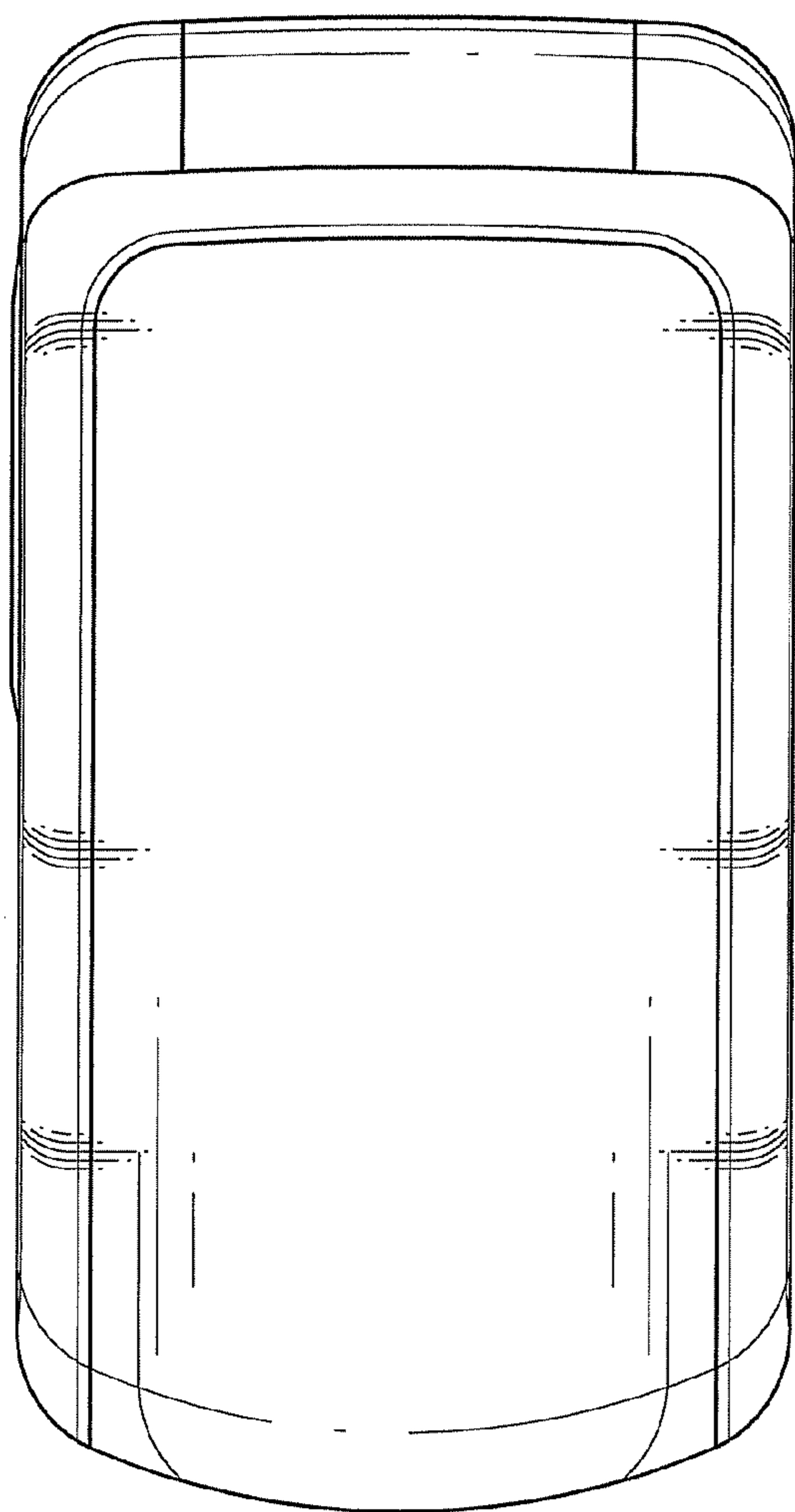

FIG. 3

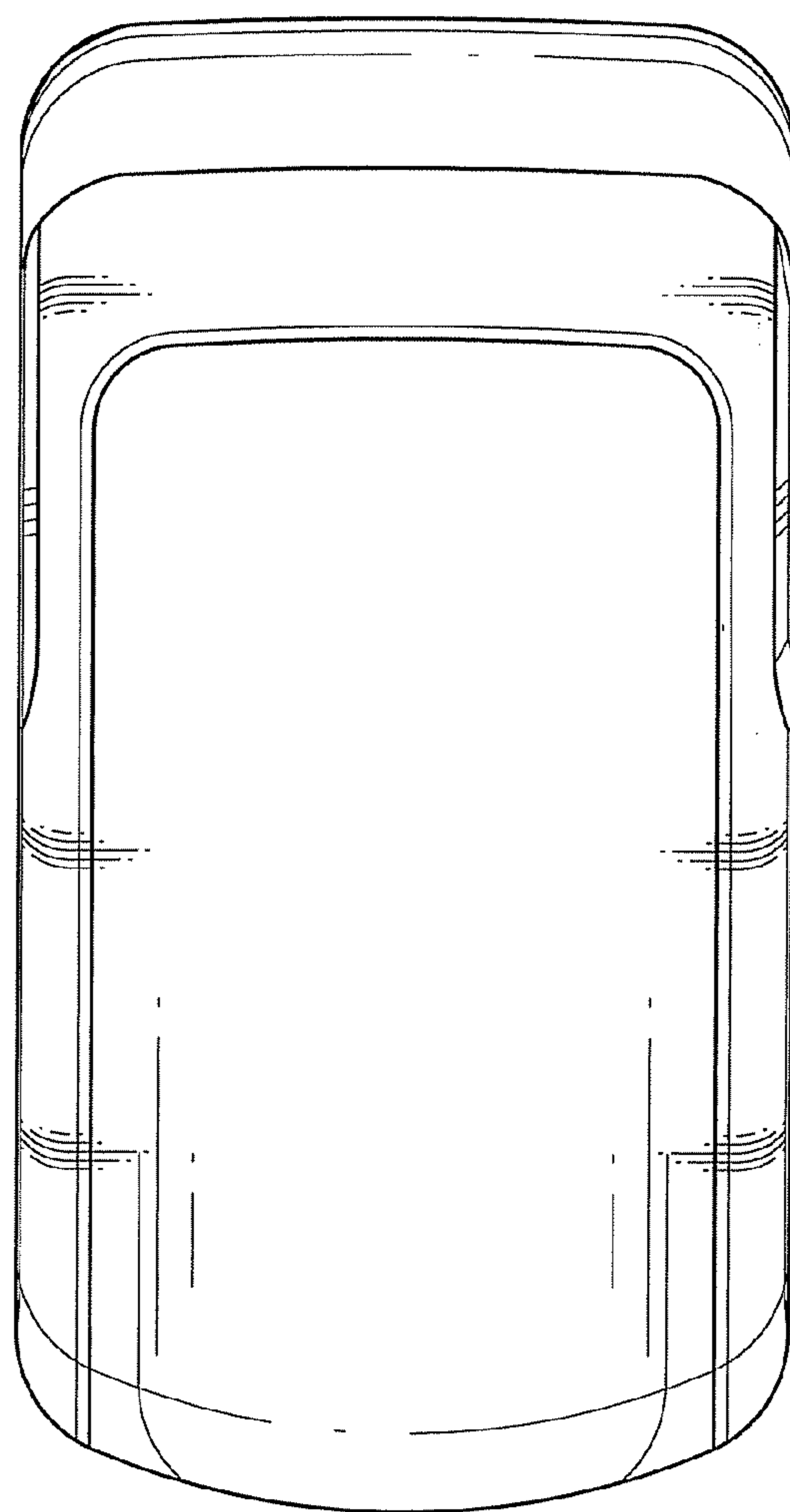

FIG. 4

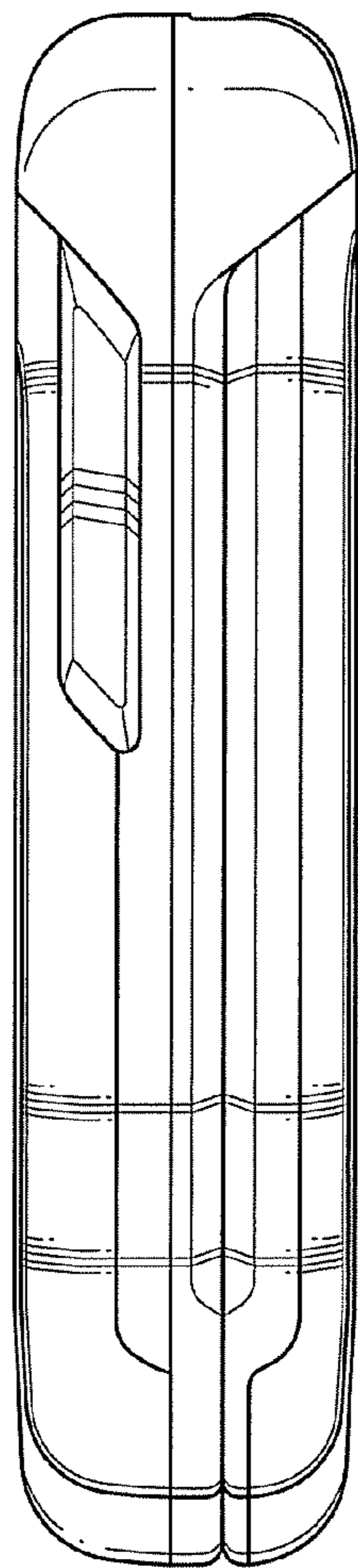

FIG. 5

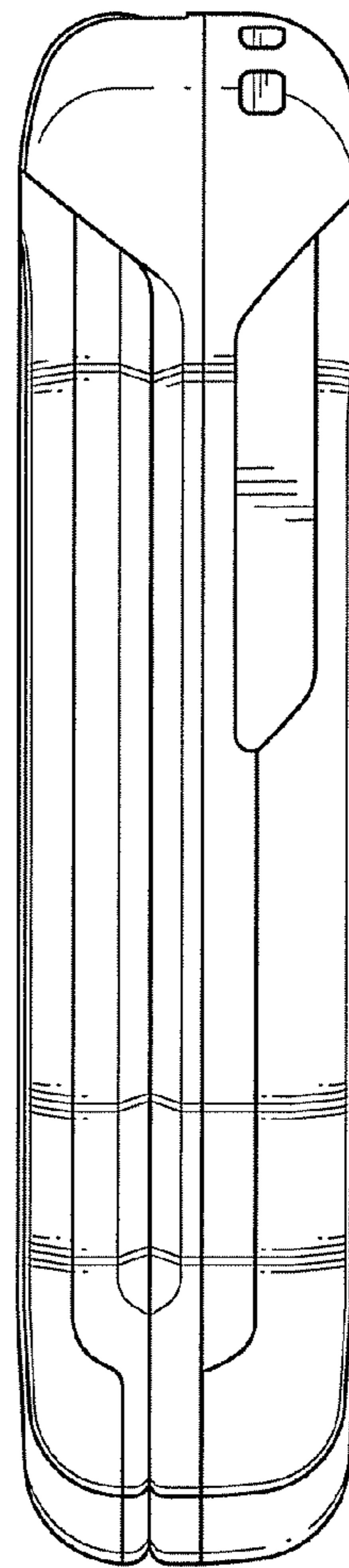

FIG. 6

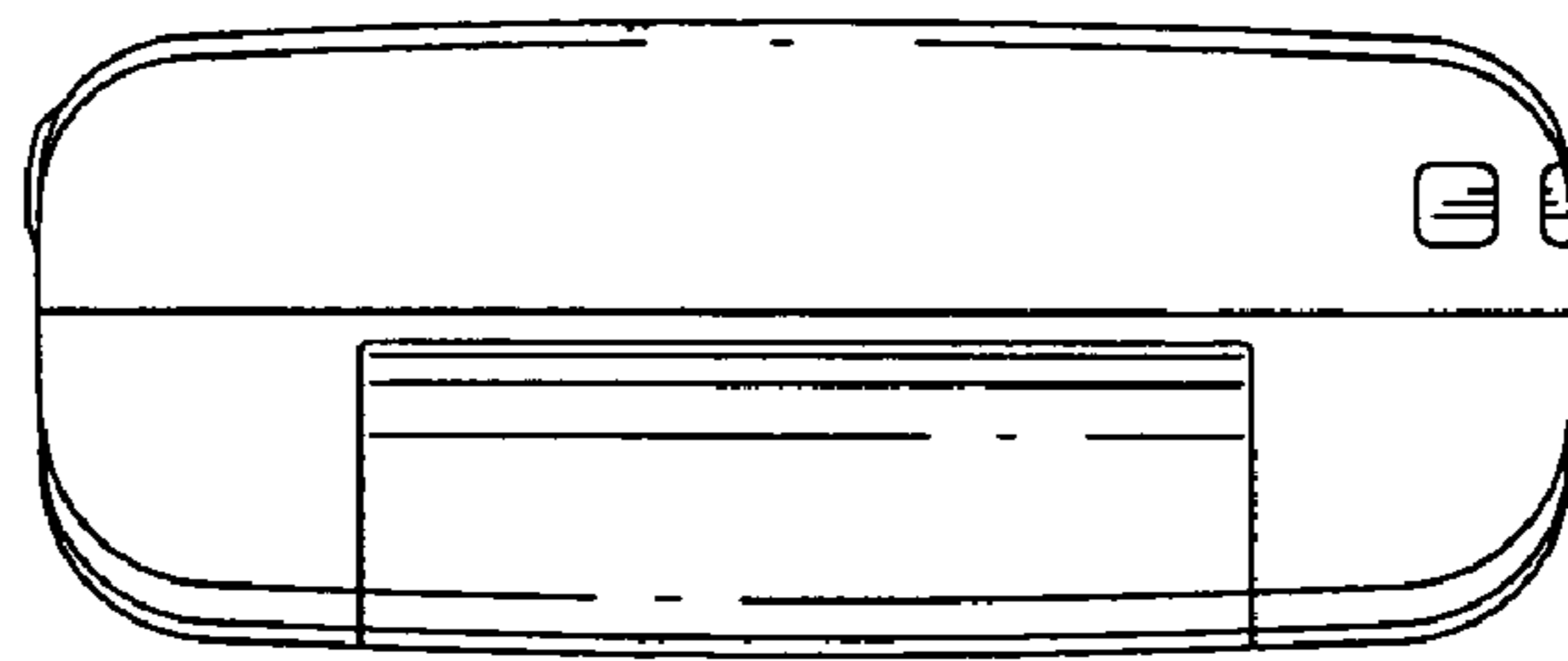

FIG. 7

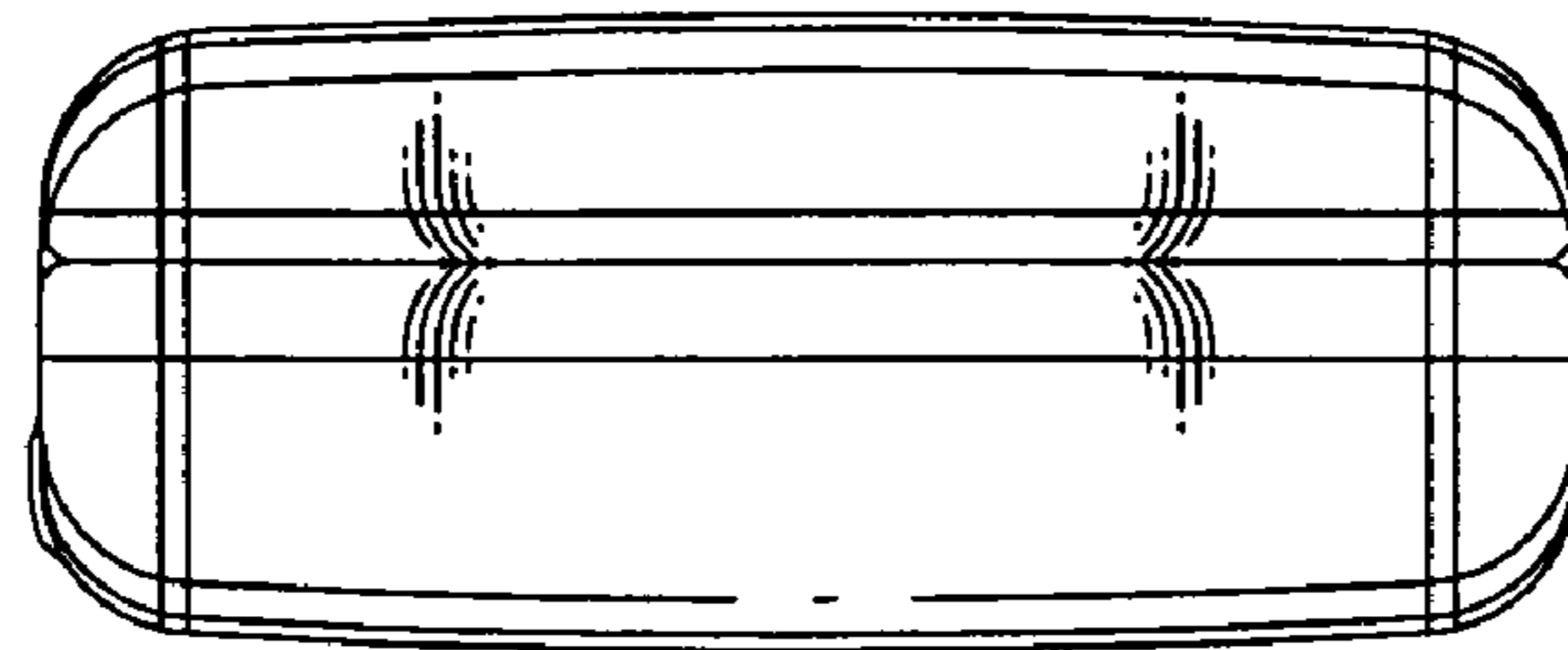

FIG. 8

