

US00D630131S

(12) **United States Design Patent**
Dyson

(10) **Patent No.:** **US D630,131 S**

(45) **Date of Patent:** **** Jan. 4, 2011**

(54) **AUTOMOBILE**

(75) Inventor: **Andrew Dyson**, Eppstein (DE)

(73) Assignee: **GM Global Technology Operations, Inc.**, Detroit, MI (US)

(**) Term: **14 Years**

(21) Appl. No.: **29/348,687**

(22) Filed: **Jan. 27, 2010**

D521,903 S *	5/2006	Matei et al.	D12/91
D533,112 S *	12/2006	Harada et al.	D12/91
D540,215 S *	4/2007	Date et al.	D12/91
D552,511 S *	10/2007	Dekena et al.	D12/91
D554,562 S *	11/2007	Adams et al.	D12/91
D559,737 S *	1/2008	Bischoff et al.	D12/91
D563,834 S *	3/2008	Tada et al.	D12/91
D568,211 S *	5/2008	Vardis et al.	D12/91
D570,251 S *	6/2008	Nakamura et al.	D12/91
D619,501 S *	7/2010	Mueller	D12/91
D621,748 S *	8/2010	Ward	D12/91
2006/0055204 A1 *	3/2006	Mathew	296/181.1

* cited by examiner

Related U.S. Application Data

(63) Continuation-in-part of application No. 29/294,249, filed on Dec. 28, 2007, now abandoned.

(51) **LOC (9) Cl.** **12-08**

(52) **U.S. Cl.** **D12/91**

(58) **Field of Classification Search** D12/82,
D12/86, 88, 90, 91, 92; D21/424, 433; 280/756;
296/96.12, 146.9, 181.1, 181.5, 185
See application file for complete search history.

(56) **References Cited**

U.S. PATENT DOCUMENTS

D331,894 S *	12/1992	Hunter	D12/91
D396,203 S *	7/1998	Uematsu et al.	D12/91
D402,319 S *	12/1998	Fu	D12/91
D416,519 S *	11/1999	Won et al.	D12/91
D447,983 S *	9/2001	Stoddard et al.	D12/91
D450,012 S *	11/2001	Matei	D12/91
D463,758 S *	10/2002	Meadows et al.	D12/91
D466,053 S *	11/2002	O'Connell et al.	D12/91
D472,850 S *	4/2003	Frasher et al.	D12/91
D480,990 S *	10/2003	Fujiyoshi	D12/91
D499,357 S *	12/2004	Velazco	D12/91
D500,262 S *	12/2004	Fukunaga et al.	D12/92
D508,435 S *	8/2005	Wakasugi et al.	D12/91

Primary Examiner—Patricia Palasik

(74) *Attorney, Agent, or Firm*—Abelman, Frayne & Schwab

(57) **CLAIM**

The ornamental design for an automobile, as shown and described.

DESCRIPTION

FIG. 1 is a right-side and front perspective view showing my new automobile design;

FIG. 2 is a left-side and front perspective view thereof;

FIG. 3 is a right-side and rear perspective view thereof;

FIG. 4 is a left-side and rear perspective view thereof;

FIG. 5 is a front elevational view thereof;

FIG. 6 is a left-side elevational view thereof;

FIG. 7 is a rear elevational view thereof;

FIG. 8 is a right-side elevational view thereof; and,

FIG. 9 is a top elevational view thereof.

The broken lines represent portions of the structure that form no part of the claim.

1 Claim, 9 Drawing Sheets

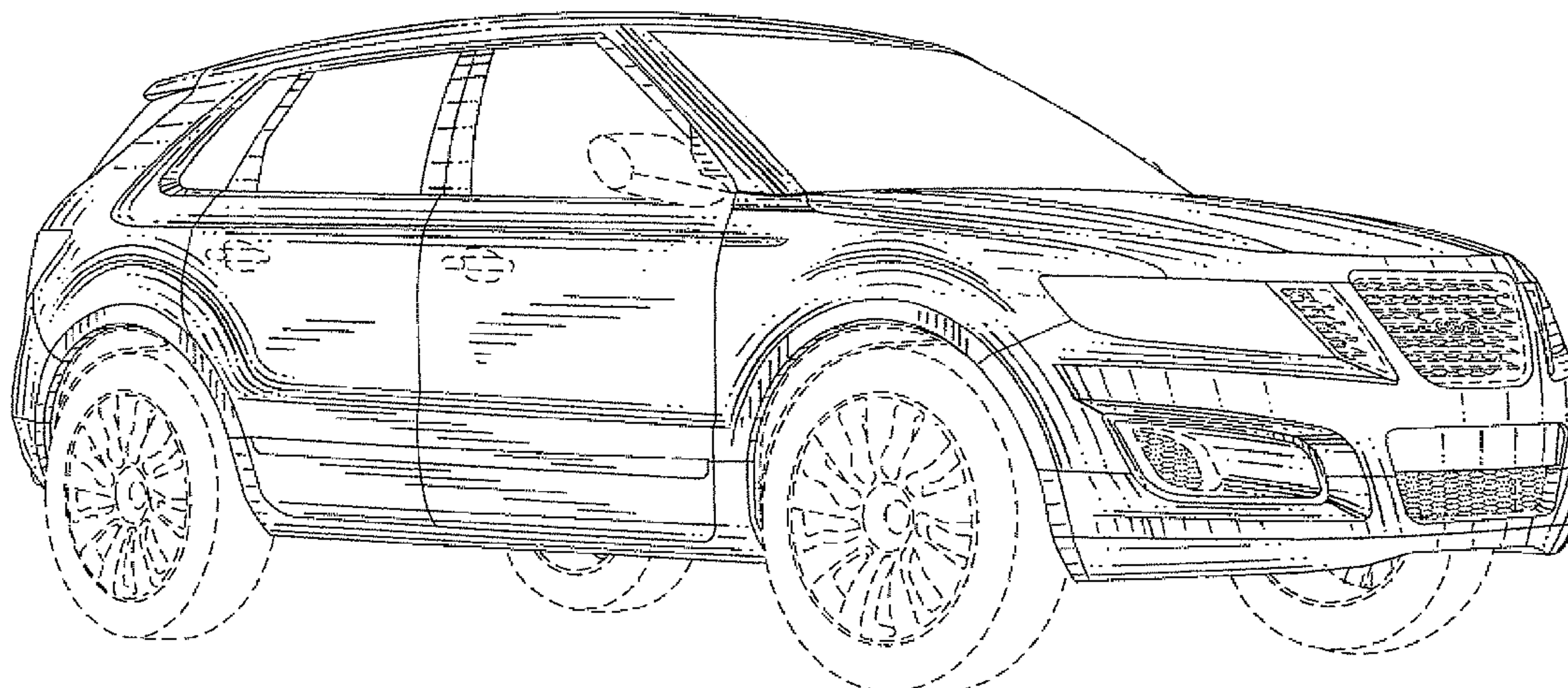

FIG. 1

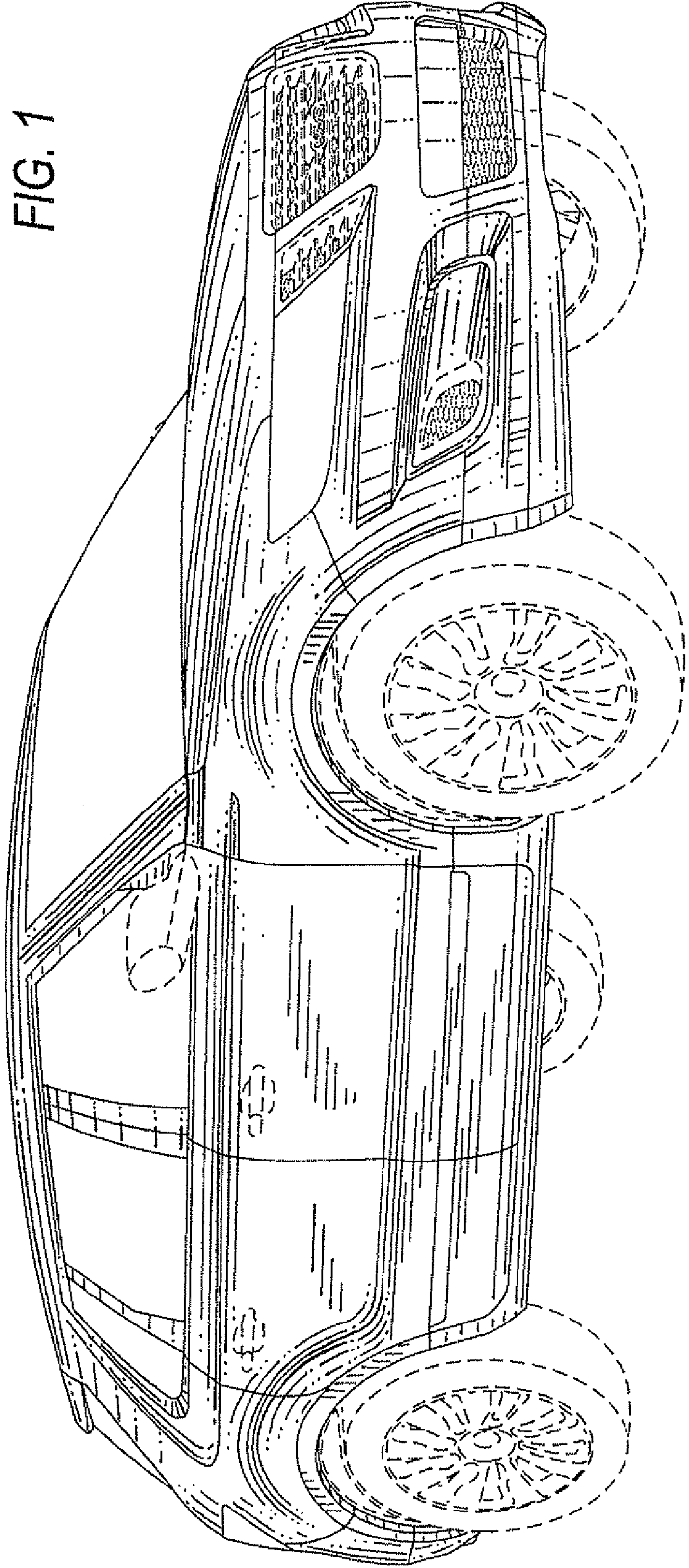

FIG. 2

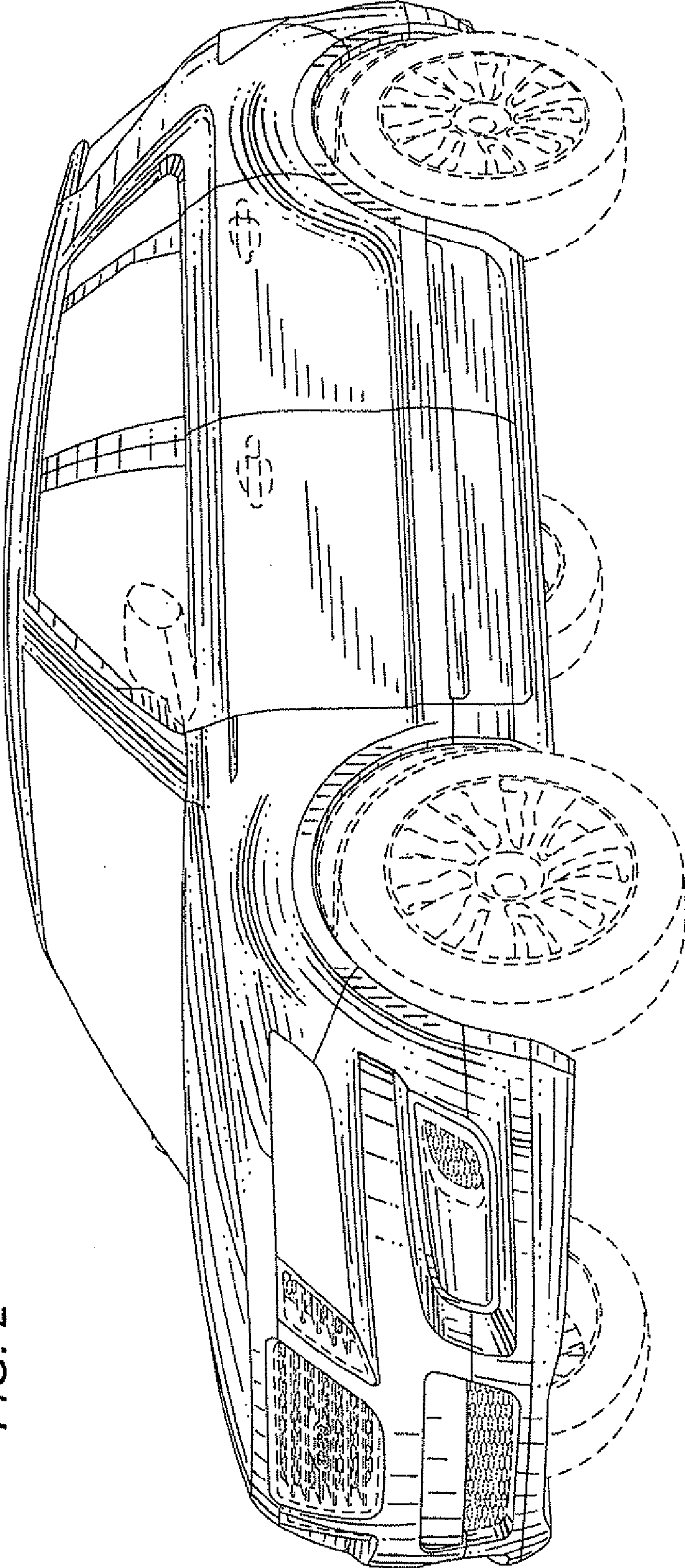
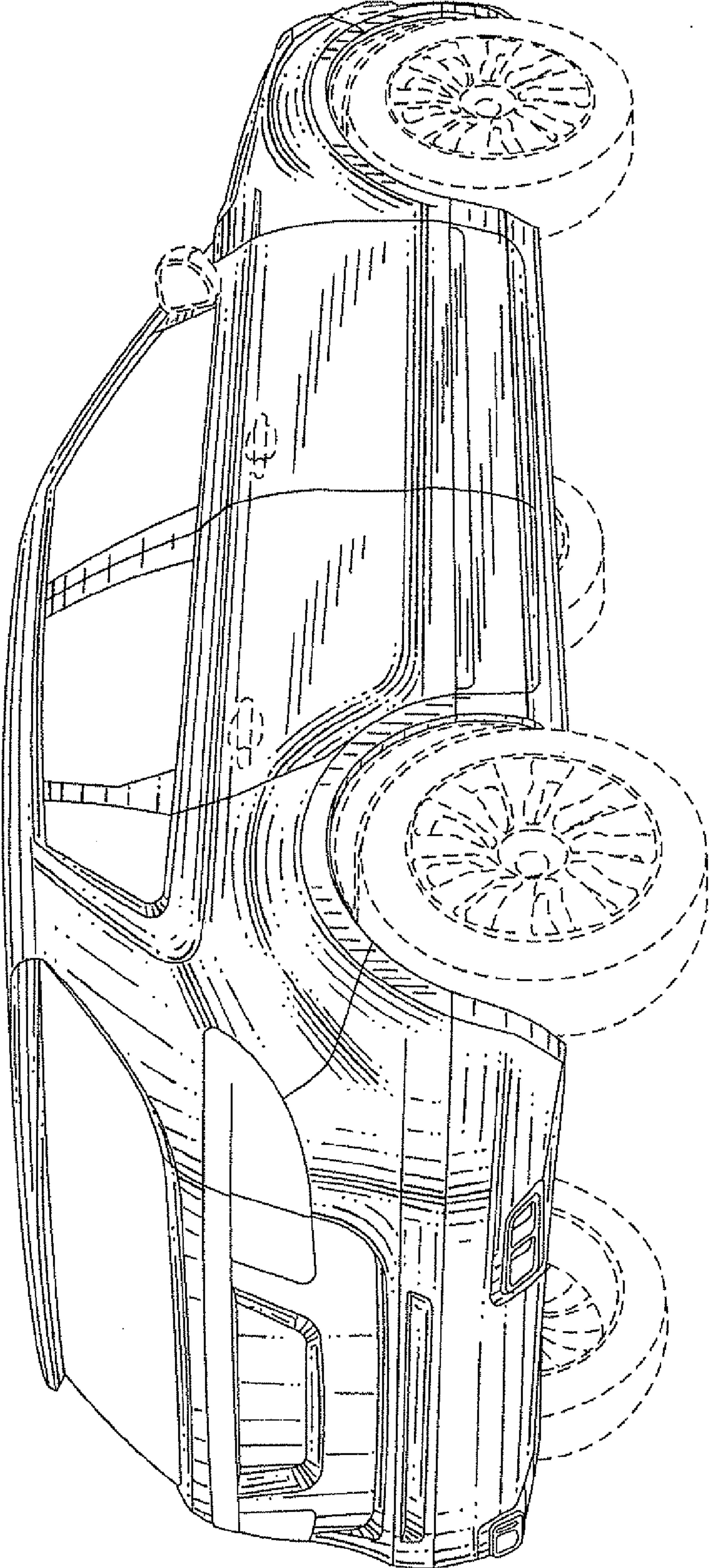

FIG. 3



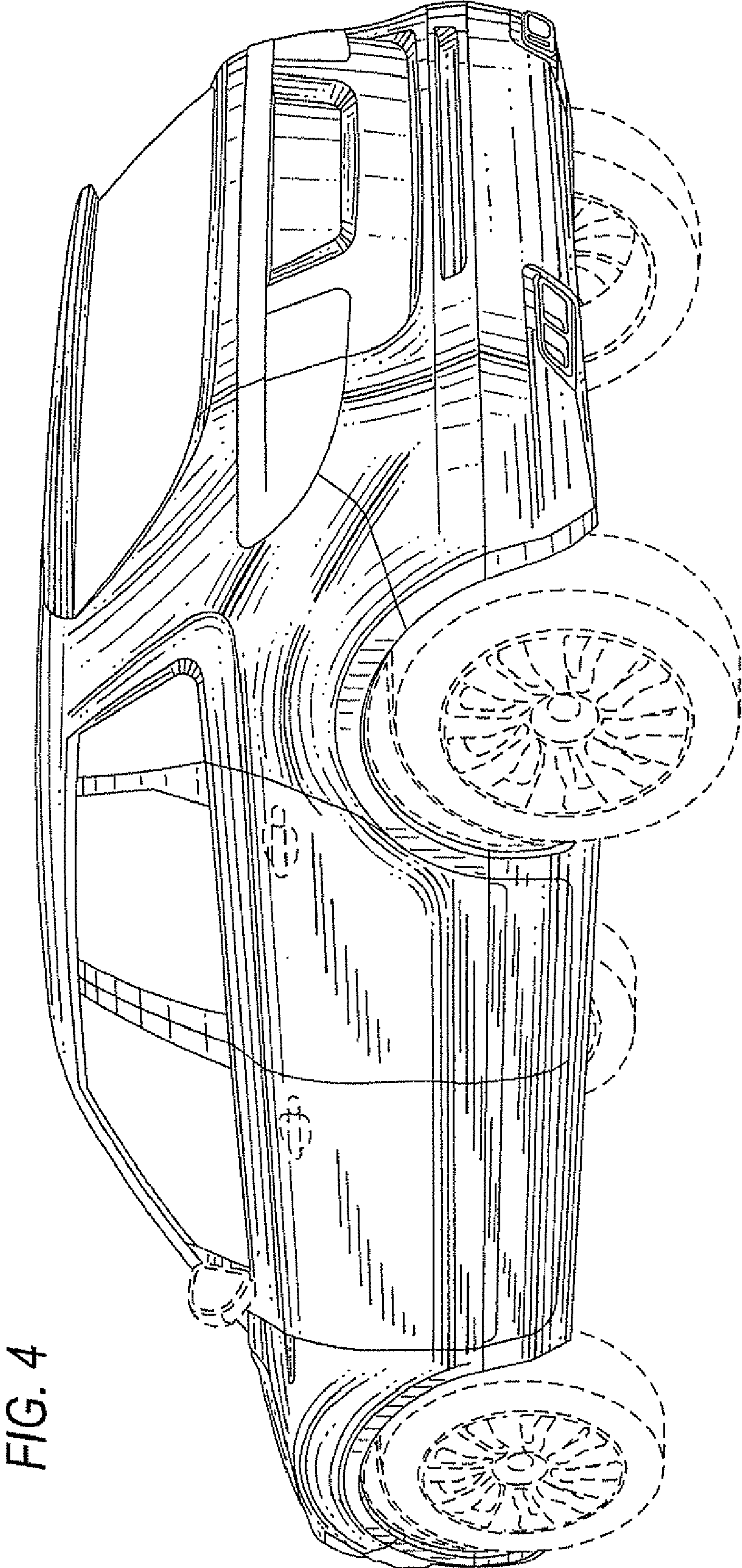

FIG. 4

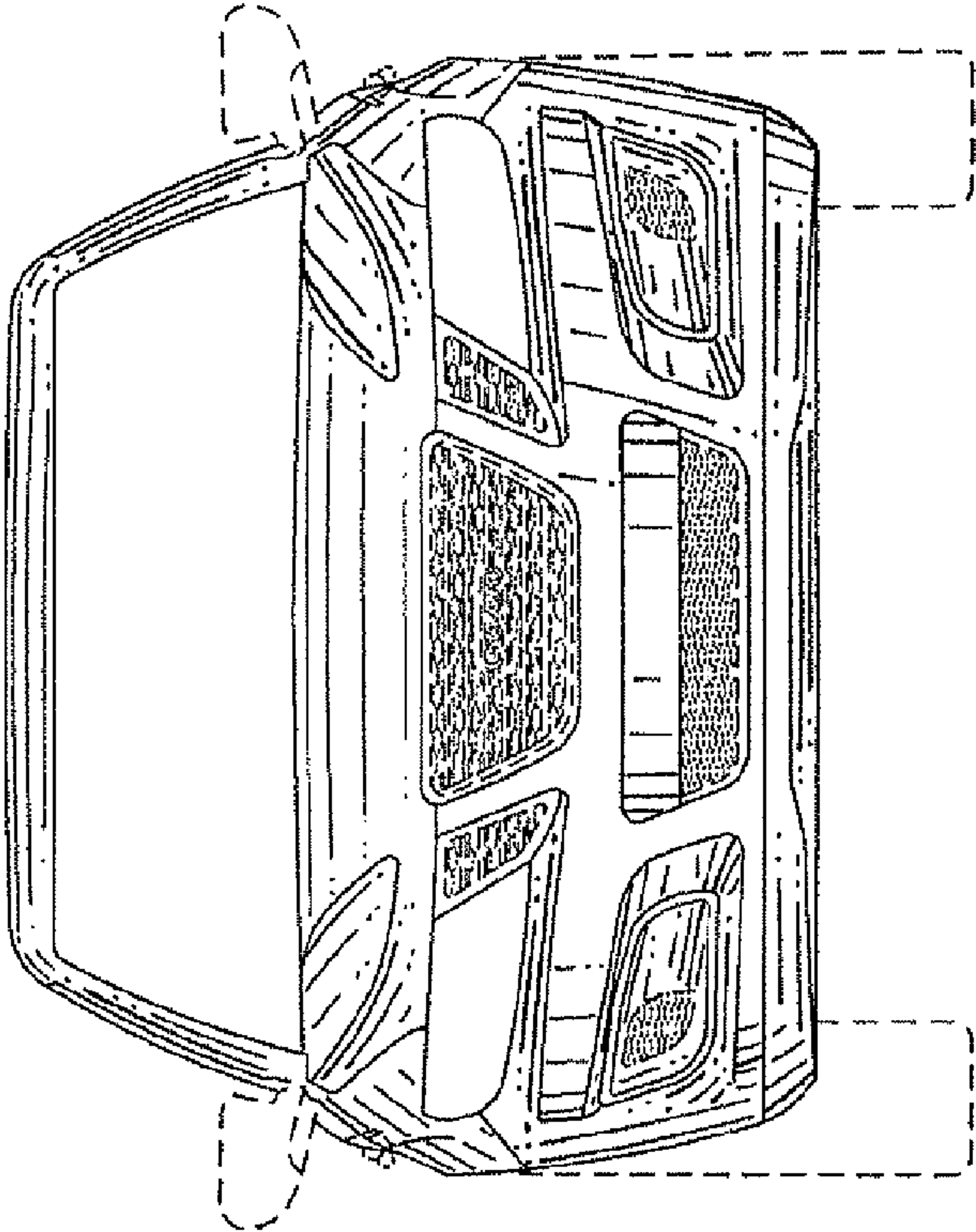

FIG. 5

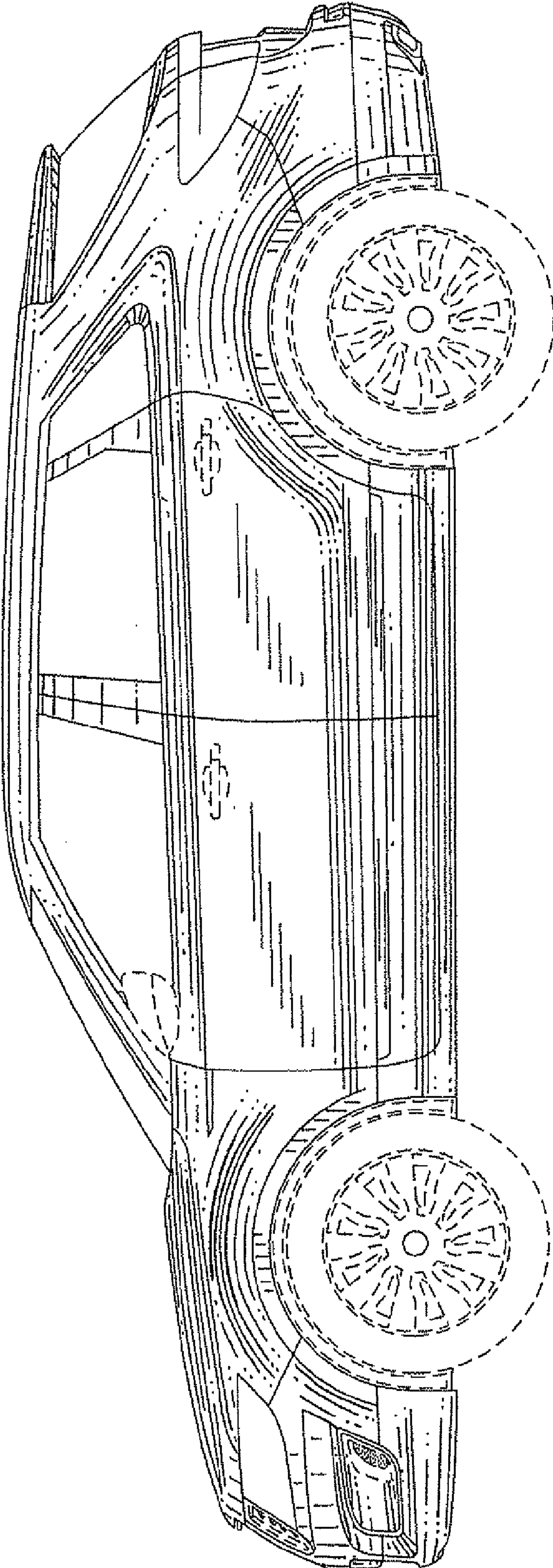

FIG. 6

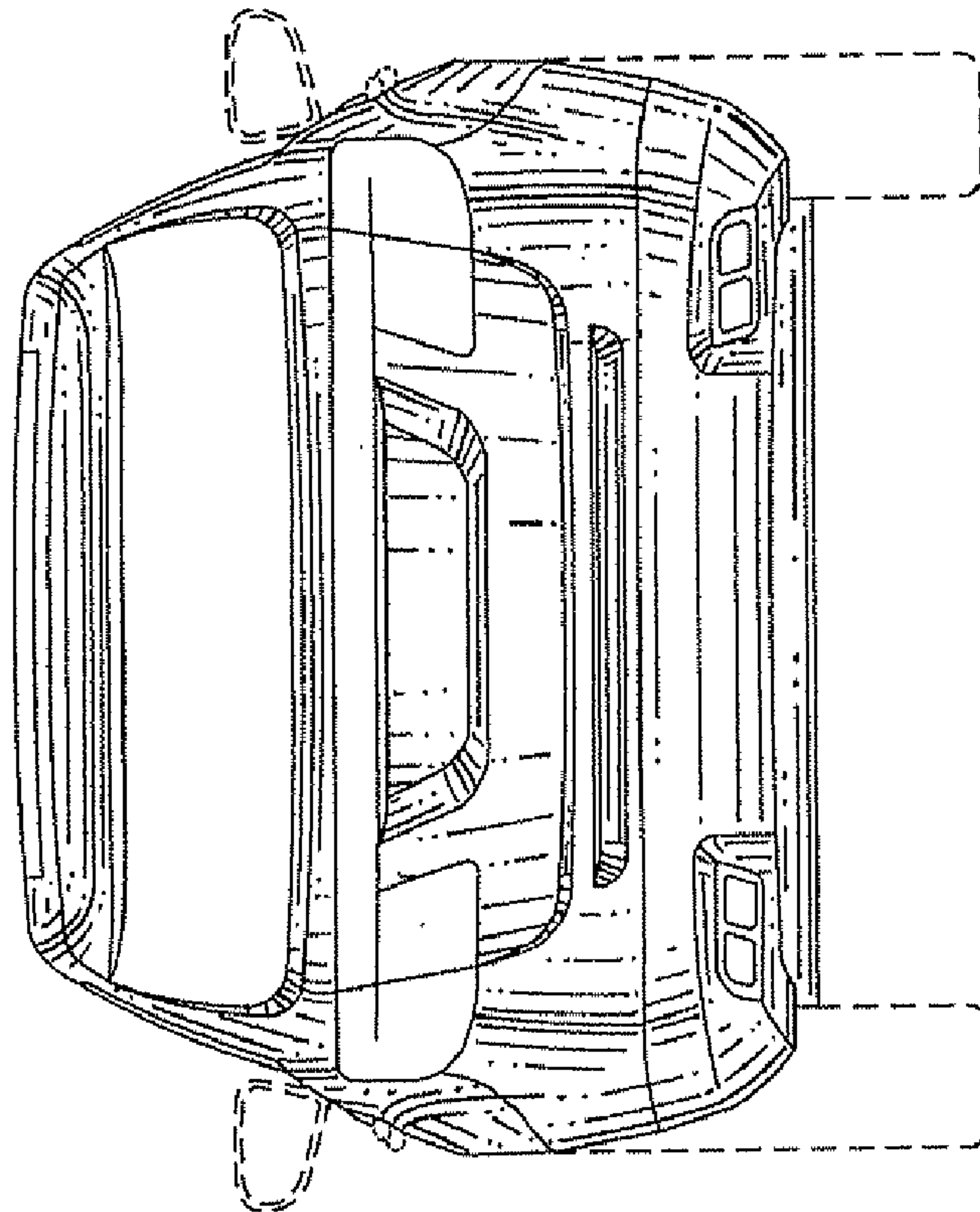

FIG. 7

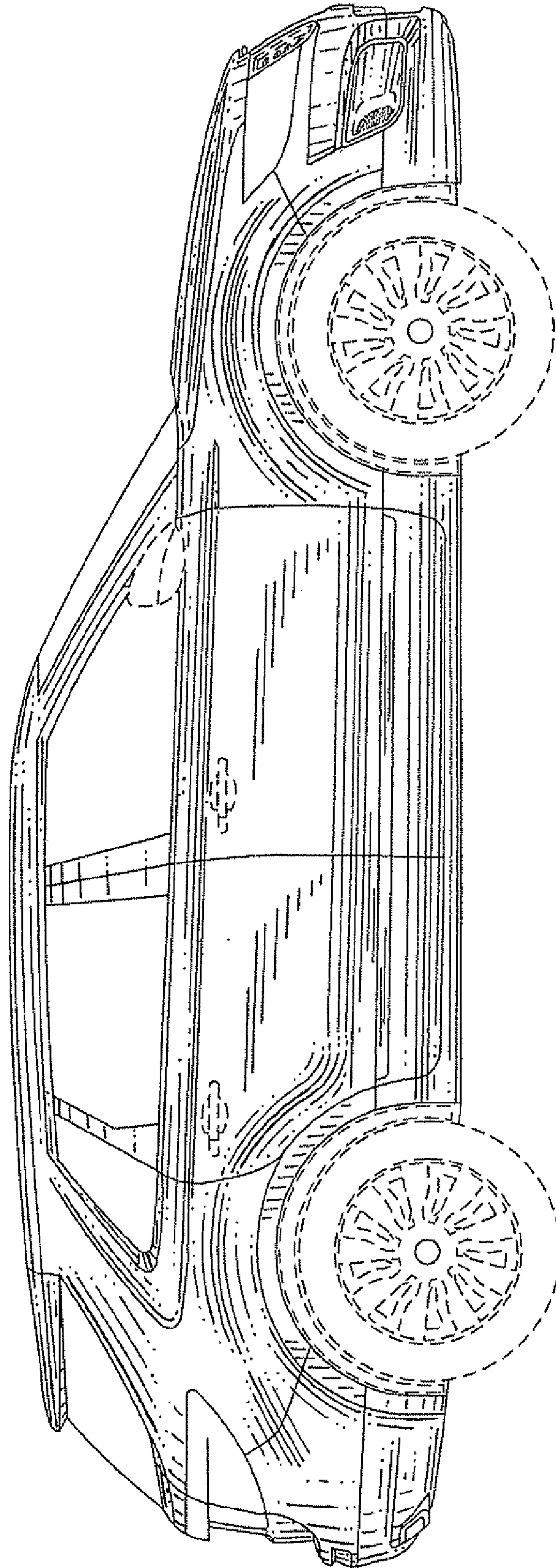

FIG. 8

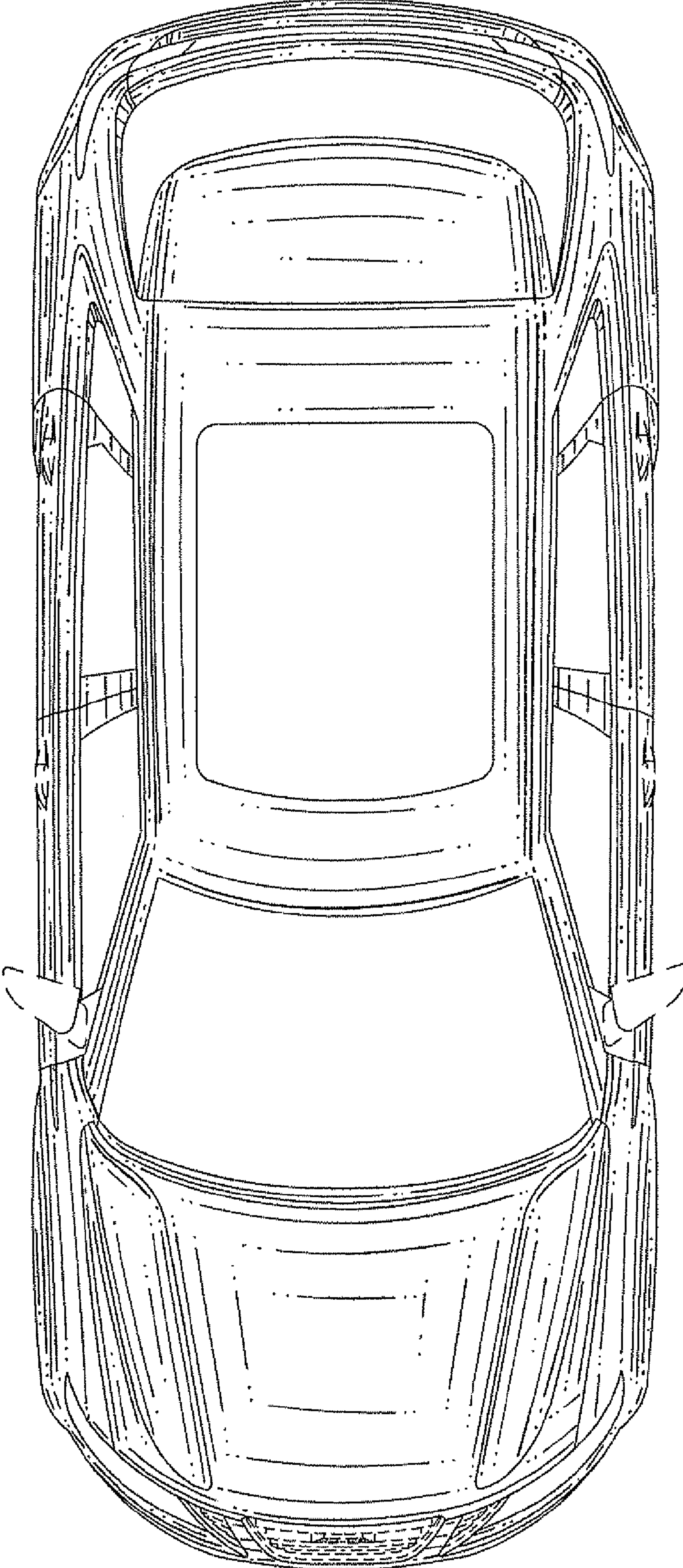

FIG. 9