



US00D630125S

(12) **United States Design Patent**
Vogt

(10) **Patent No.:** **US D630,125 S**
(45) **Date of Patent:** **** Jan. 4, 2011**

(54) **ROTARY PLANT BASKET HANGER**

(57) **CLAIM**

(76) **Inventor:** **Paul Andrew Vogt**, 1058 Ottawa Ave.,
W. St. Paul, MN (US) 55118

The ornamental design for rotary plant basket hanger, as shown and described.

(**) **Term:** **14 Years**

DESCRIPTION

(21) **Appl. No.:** **29/348,739**

(22) **Filed:** **Feb. 3, 2010**

(51) **LOC (9) Cl.** **11-02**

(52) **U.S. Cl.** **D11/164; D11/148**

(58) **Field of Classification Search** D6/403-405,
D6/556-558; D8/1; D11/143-156, 164;
D19/77, 80-82, 84; D25/100; D26/9-11,
D26/16-18, 20, 22; D34/1, 2, 4-6; D99/5,
D99/19; 47/32.7, 33, 39, 41.01, 41.1, 41.12,
47/41.13, 41.15, 44-47, 65.5, 65.9, 66.1,
47/66.3-66.6, 67-70; 248/318

See application file for complete search history.

FIG. 1 is a front perspective view of a rotary plant basket hanger, showing my new design, wherein the broken lines show a flower pot which forms no part of the claimed design;

FIG. 2 is an exploded front perspective view thereof, shown in an alternate position of use;

FIG. 3 is a top plan view thereof, shown at an enlarged scale;

FIG. 4 is a bottom plan view thereof, shown at an enlarged scale;

FIG. 5 is an exploded top plan view thereof, shown at an enlarged scale;

FIG. 6 is an exploded bottom plan view thereof, shown at an enlarged scale;

FIG. 7 is an exploded front perspective view of a second embodiment of a revolving plant basket hanger;

FIG. 8 is a top plan view thereof, shown at an enlarged scale;

FIG. 9 is a bottom plan view thereof, shown at an enlarged scale;

FIG. 10 is an exploded top plan view thereof, shown at an enlarged scale;

FIG. 11 is an exploded bottom plan view thereof, shown at an enlarged scale;

FIG. 12 is an exploded front perspective view of a third embodiment of a revolving plant basket hanger;

FIG. 13 is a top plan view thereof, shown at an enlarged scale;

FIG. 14 is a bottom plan view thereof, shown at an enlarged scale;

FIG. 15 is an exploded top plan view thereof, shown at an enlarged scale; and,

FIG. 16 is an exploded bottom plan view thereof, shown at an enlarged scale.

(56) **References Cited**

U.S. PATENT DOCUMENTS

3,943,661	A *	3/1976	DeVito et al.	47/67
4,440,371	A *	4/1984	Wijsman	47/67
D283,992	S *	5/1986	Tendrup et al.	D11/148
4,744,171	A *	5/1988	Hilliard	47/67
D351,571	S *	10/1994	Schmidt et al.	D11/148
5,779,210	A *	7/1998	Canson et al.	47/67
5,836,109	A *	11/1998	Kunz et al.	47/67
D436,840	S	1/2001	Vogt	
D566,615	S	4/2008	Vogt	

(Continued)

OTHER PUBLICATIONS

Pending U.S. Appl. No. 29/316,728 Applicant Paul A. Vogt.

Primary Examiner—Garth Rademaker

1 Claim, 6 Drawing Sheets

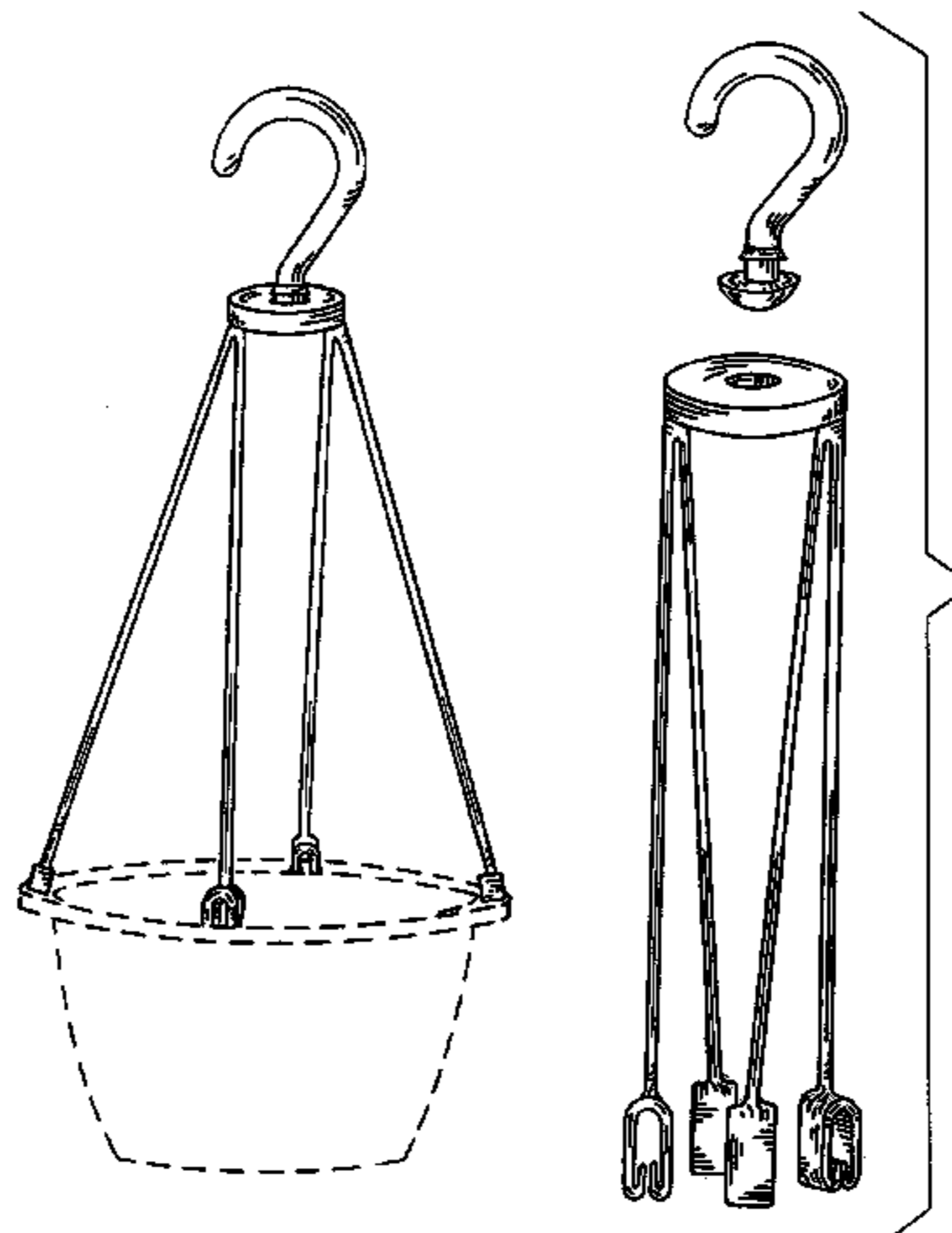

US D630,125 S

Page 2

U.S. PATENT DOCUMENTS				
				2006/0059776 A1* 3/2006 Luken et al. 47/67
D611,876 S *	3/2010	White D11/148	2006/0273230 A1* 12/2006 Logan et al. 47/67
D611,877 S *	3/2010	White D11/148	
2005/0077445 A1*	4/2005	Vogt 47/67	* cited by examiner

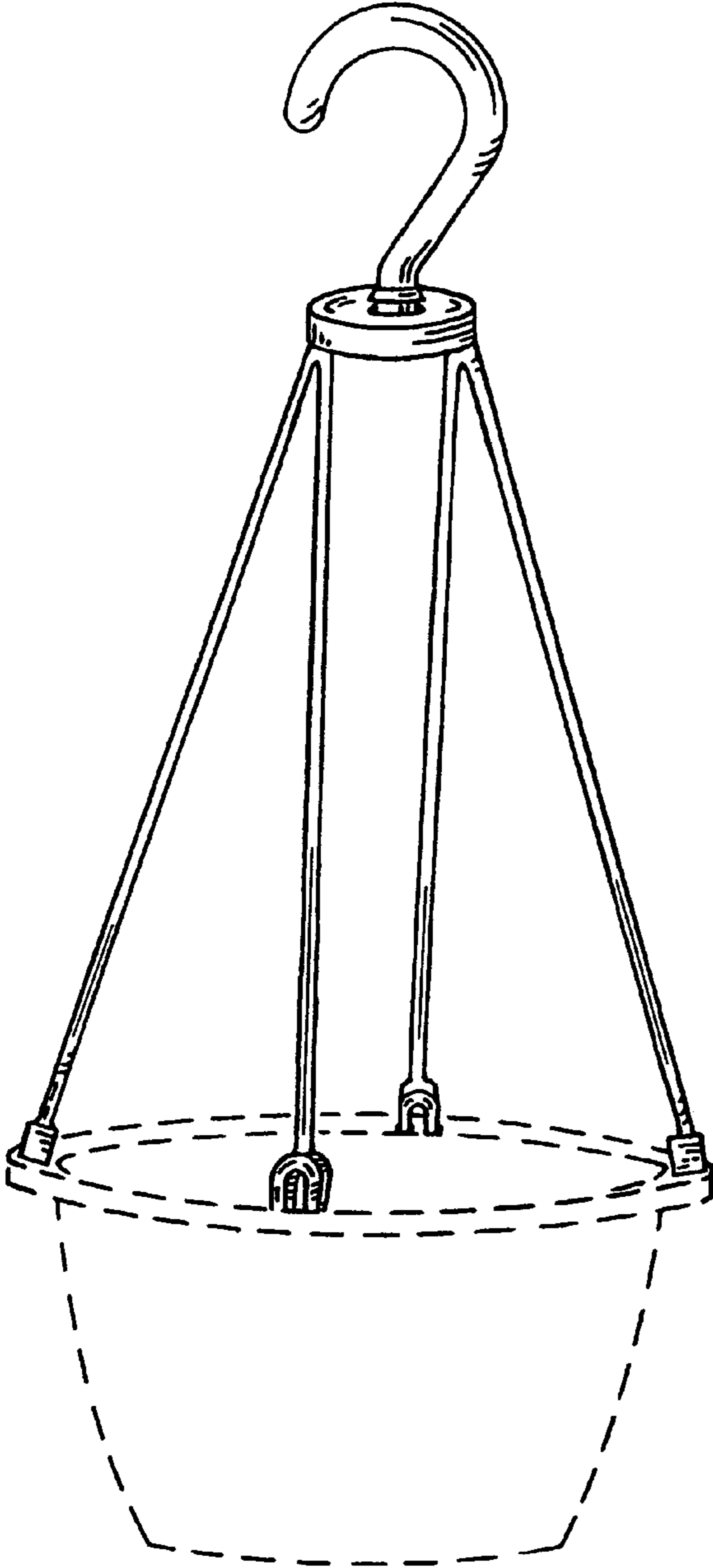

FIG. 1

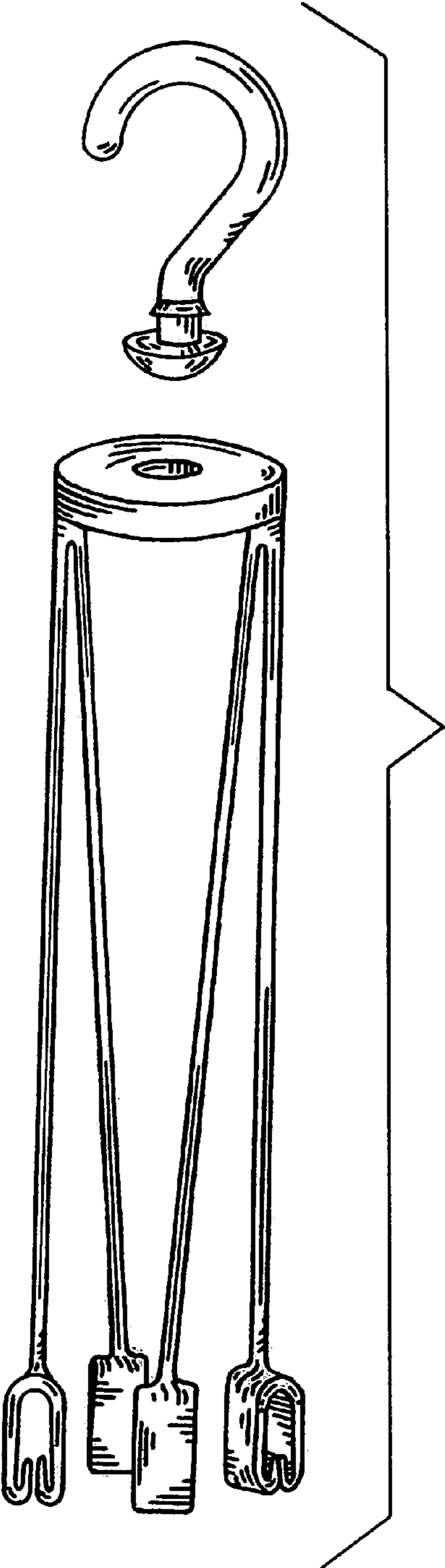

FIG. 2

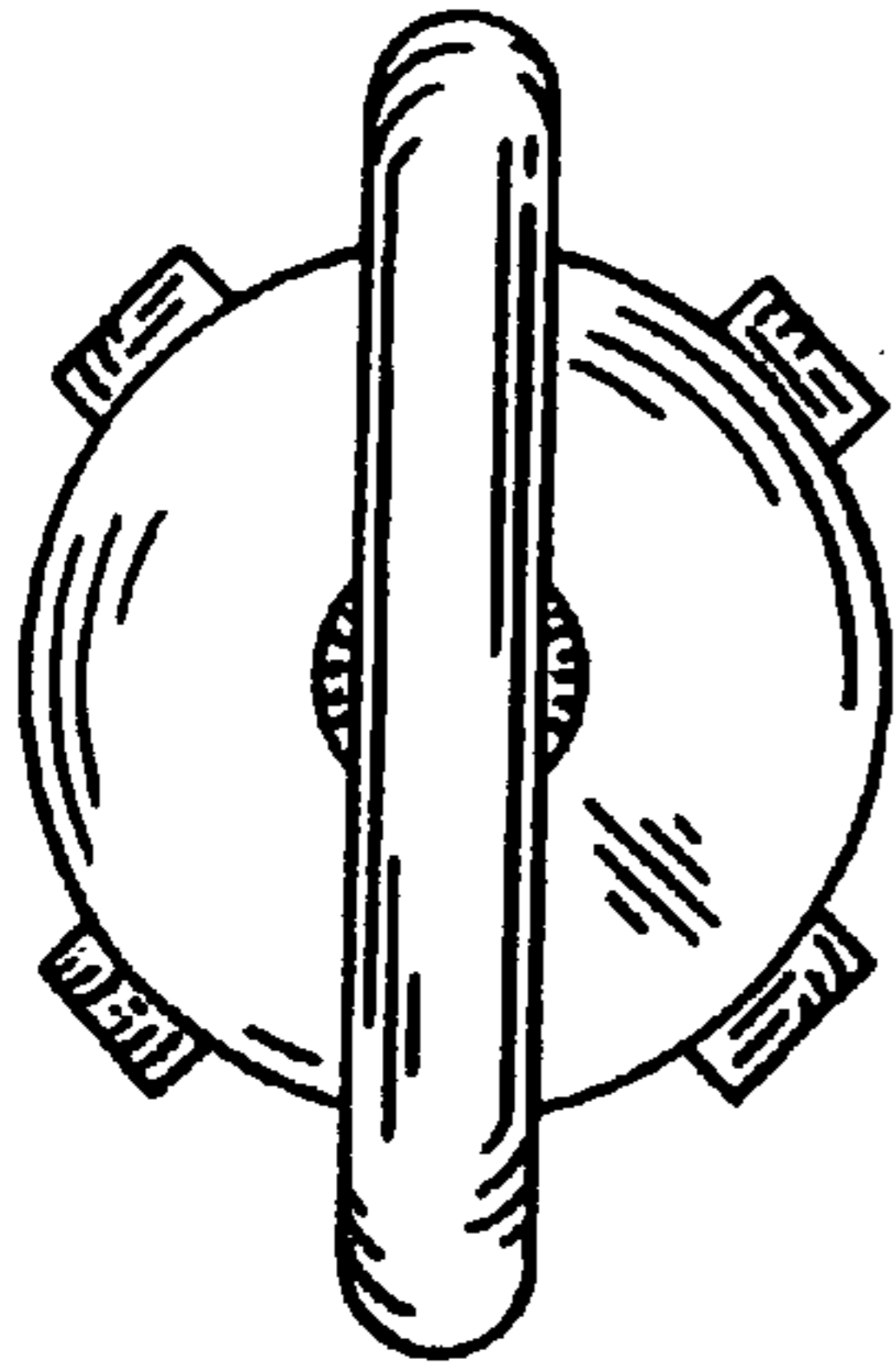

FIG. 3

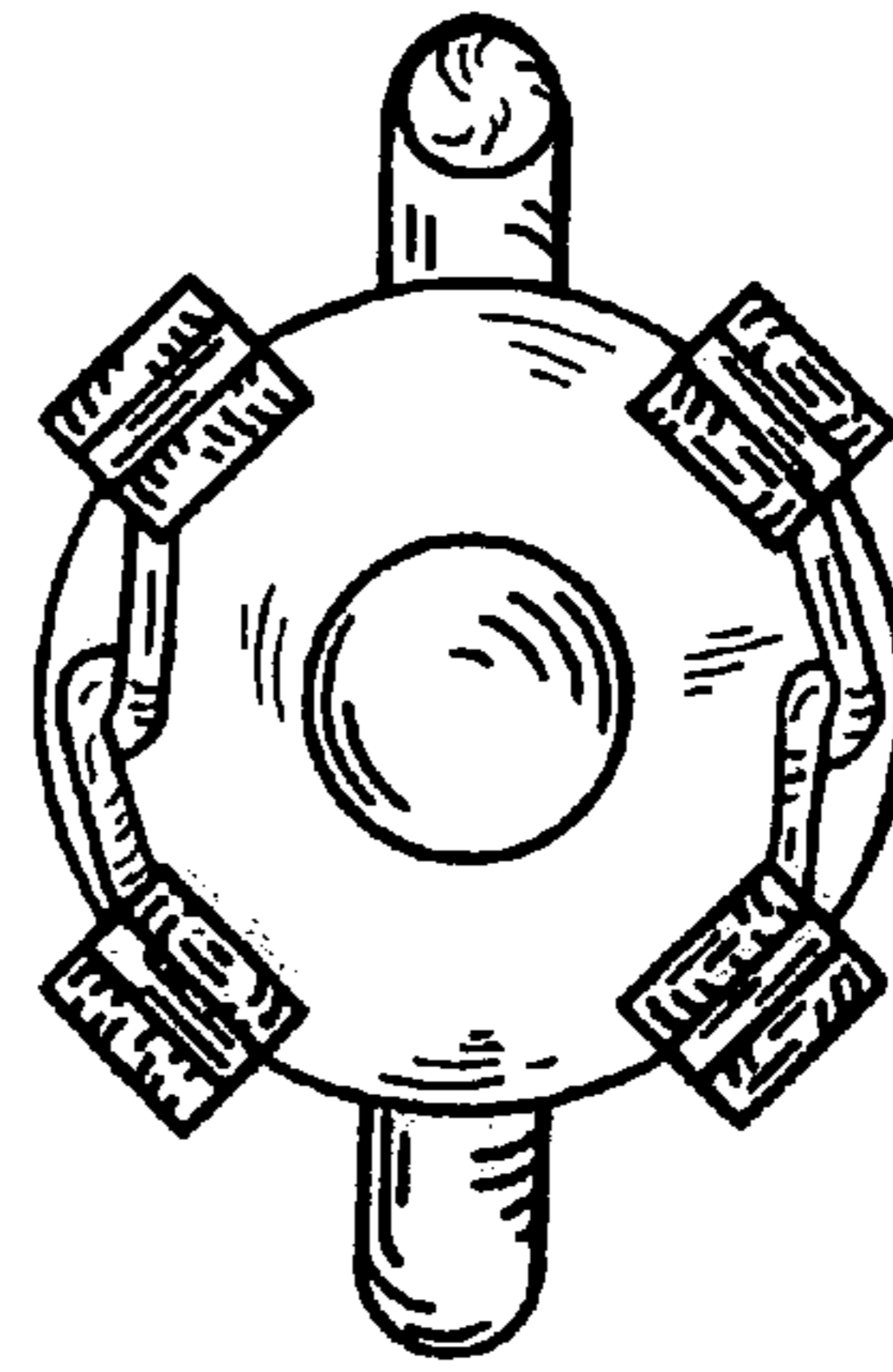

FIG. 4

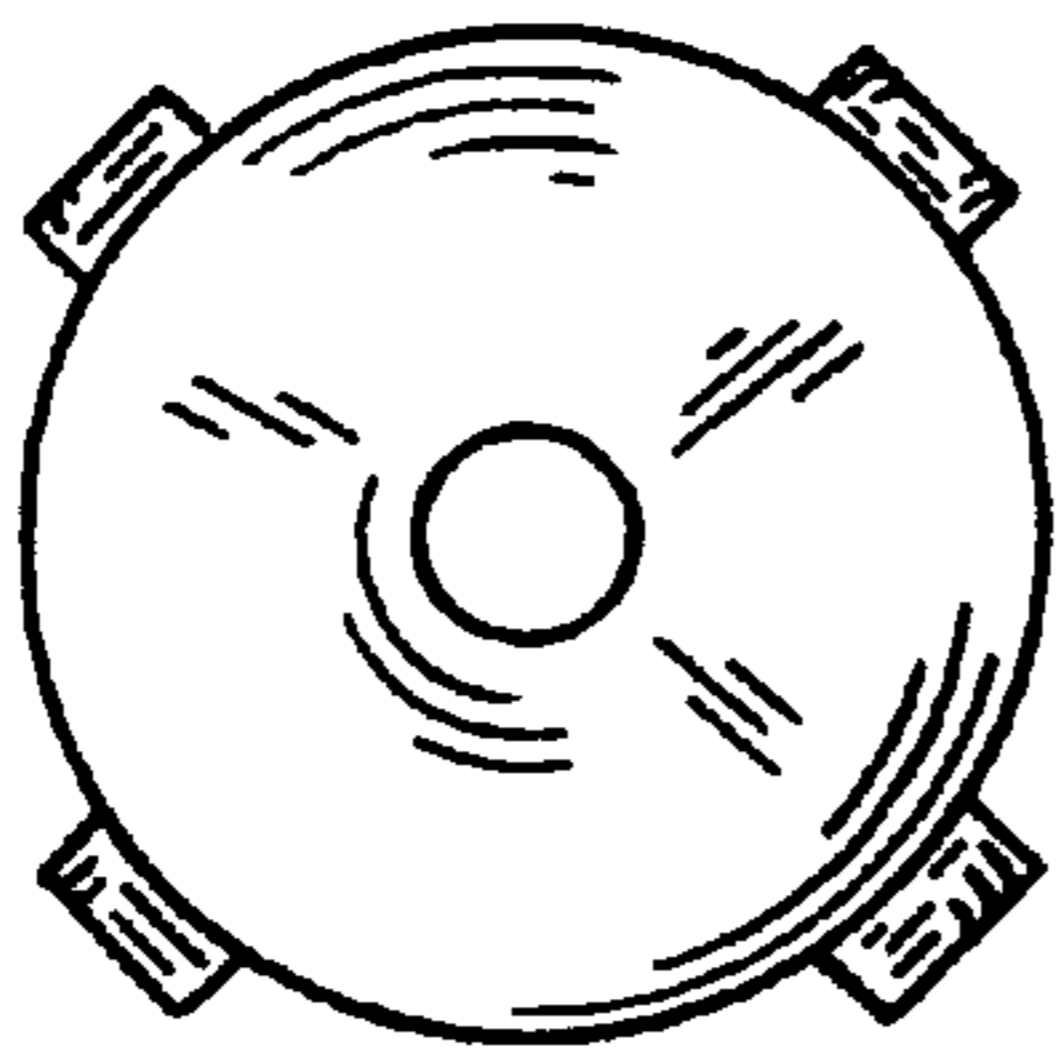

FIG. 5

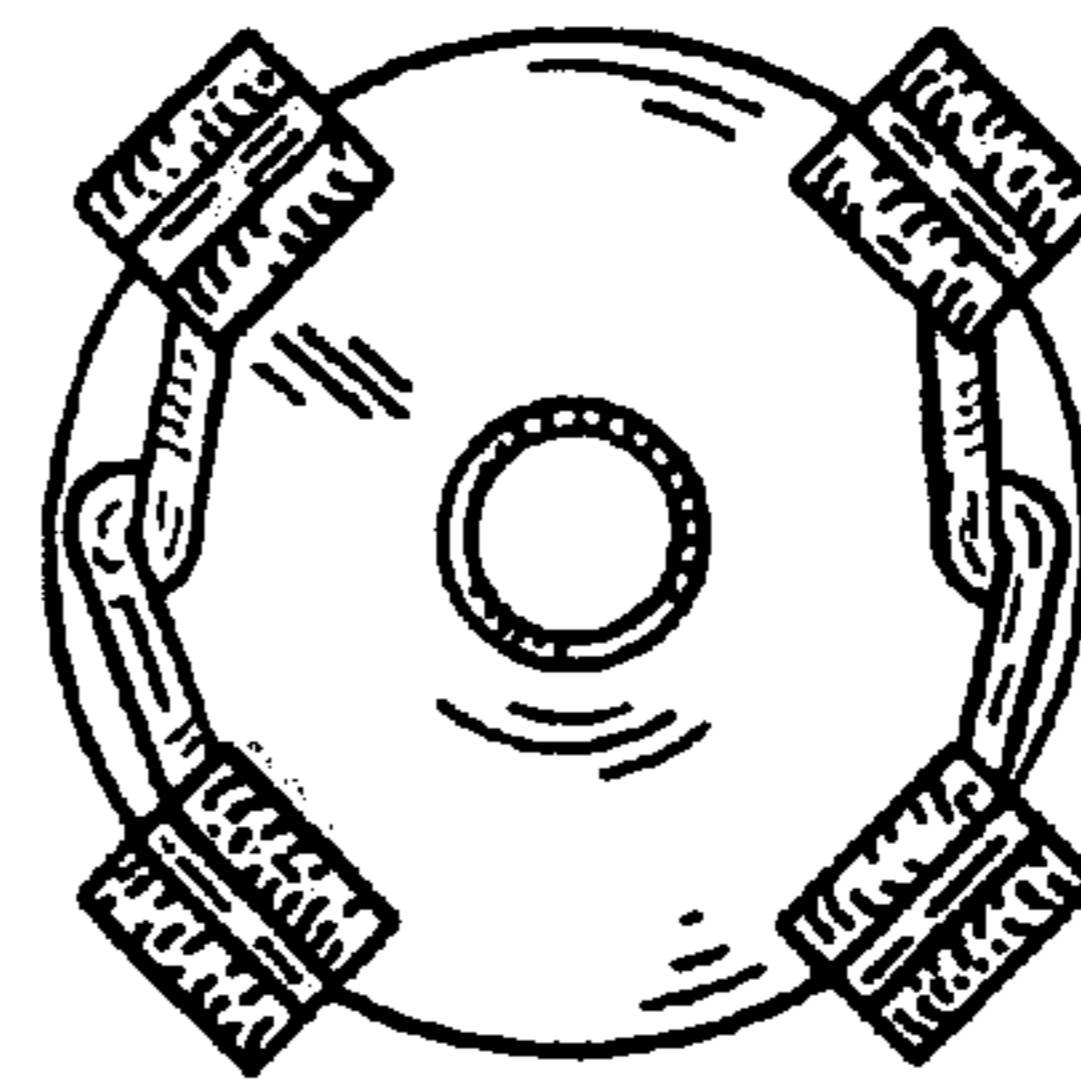
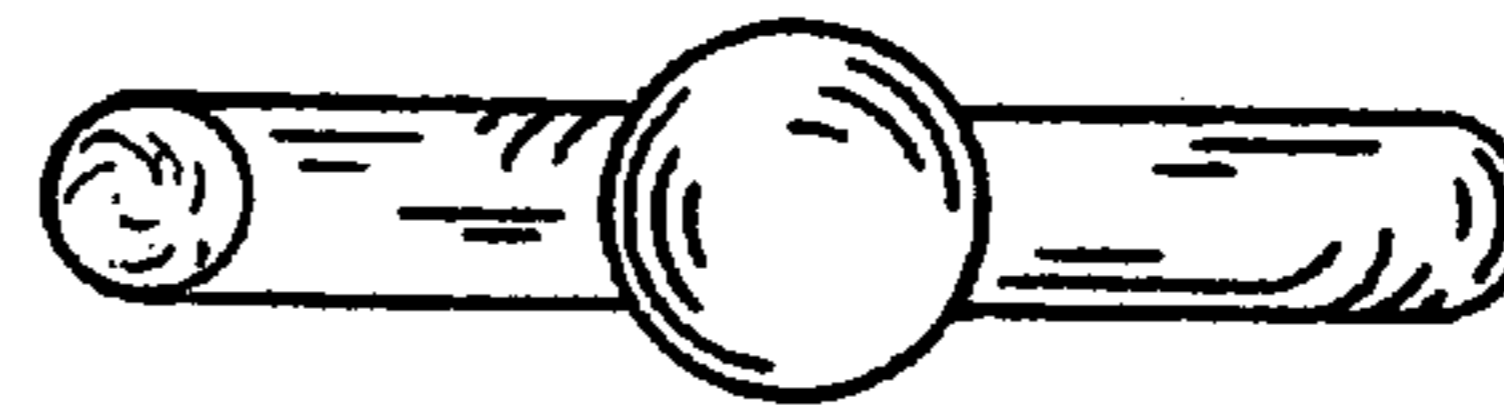

FIG. 6

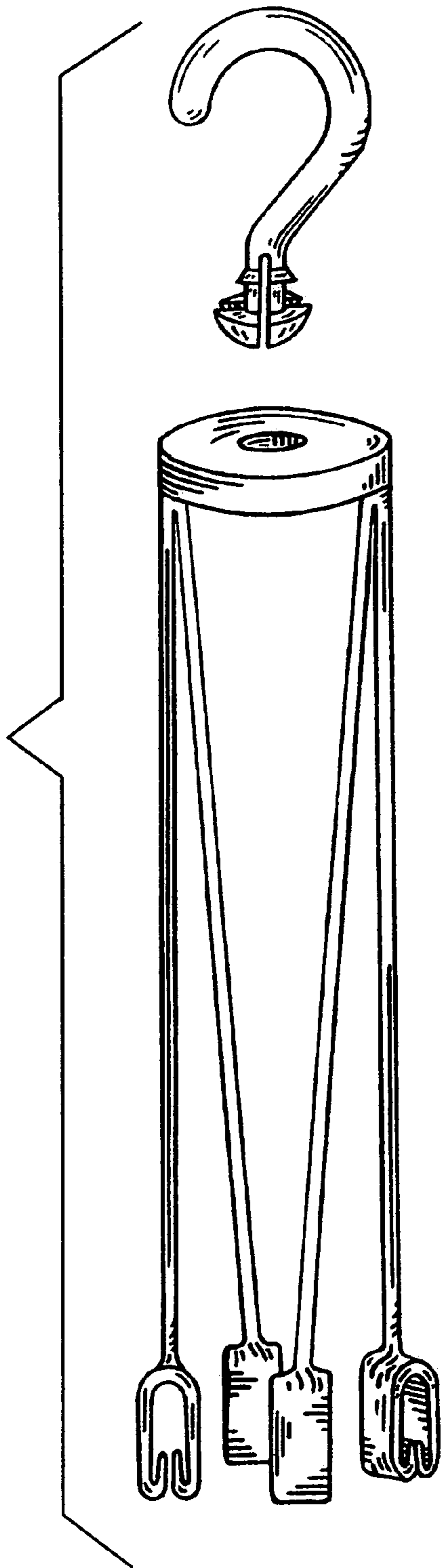

FIG. 7

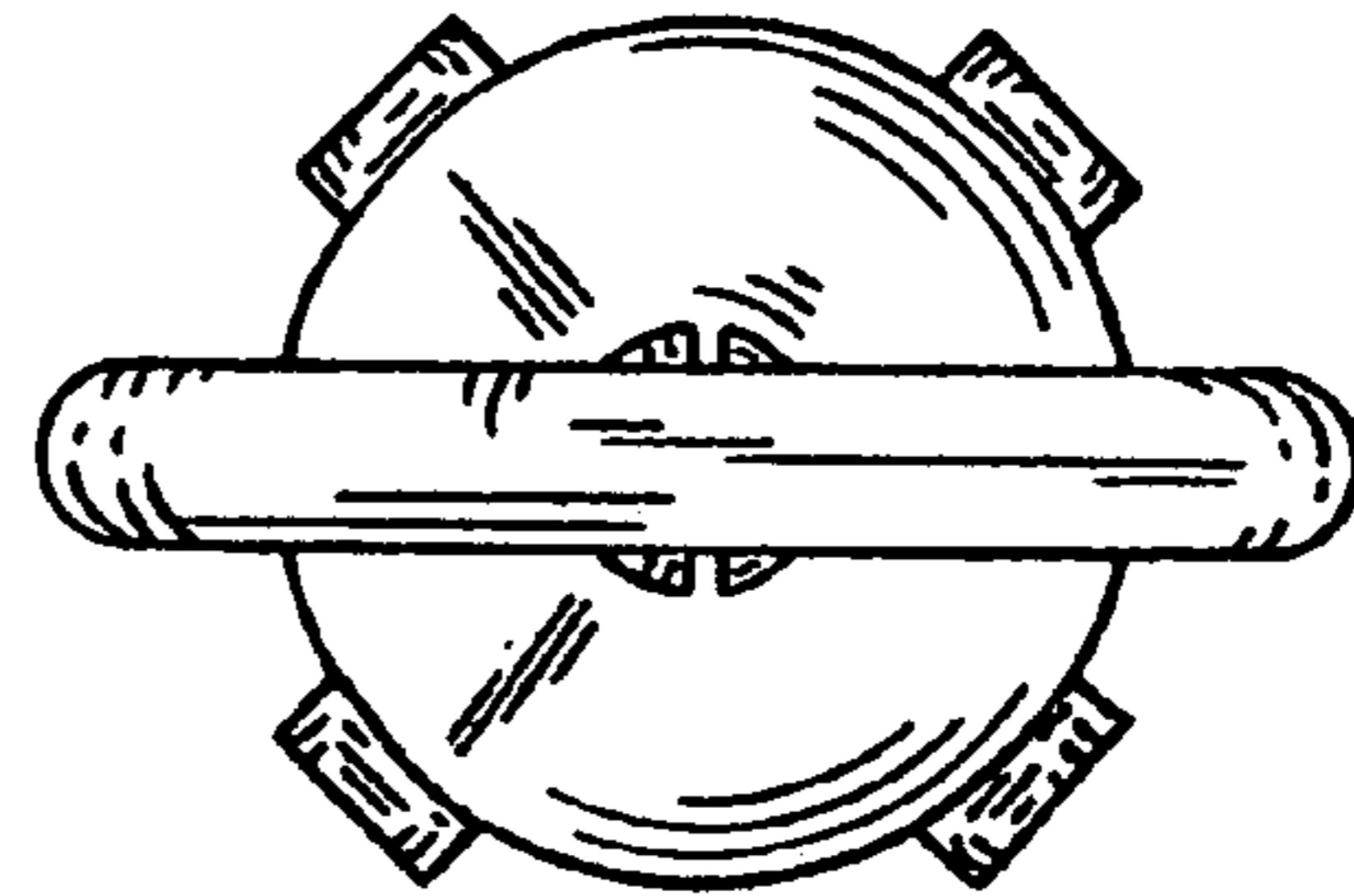

FIG. 8

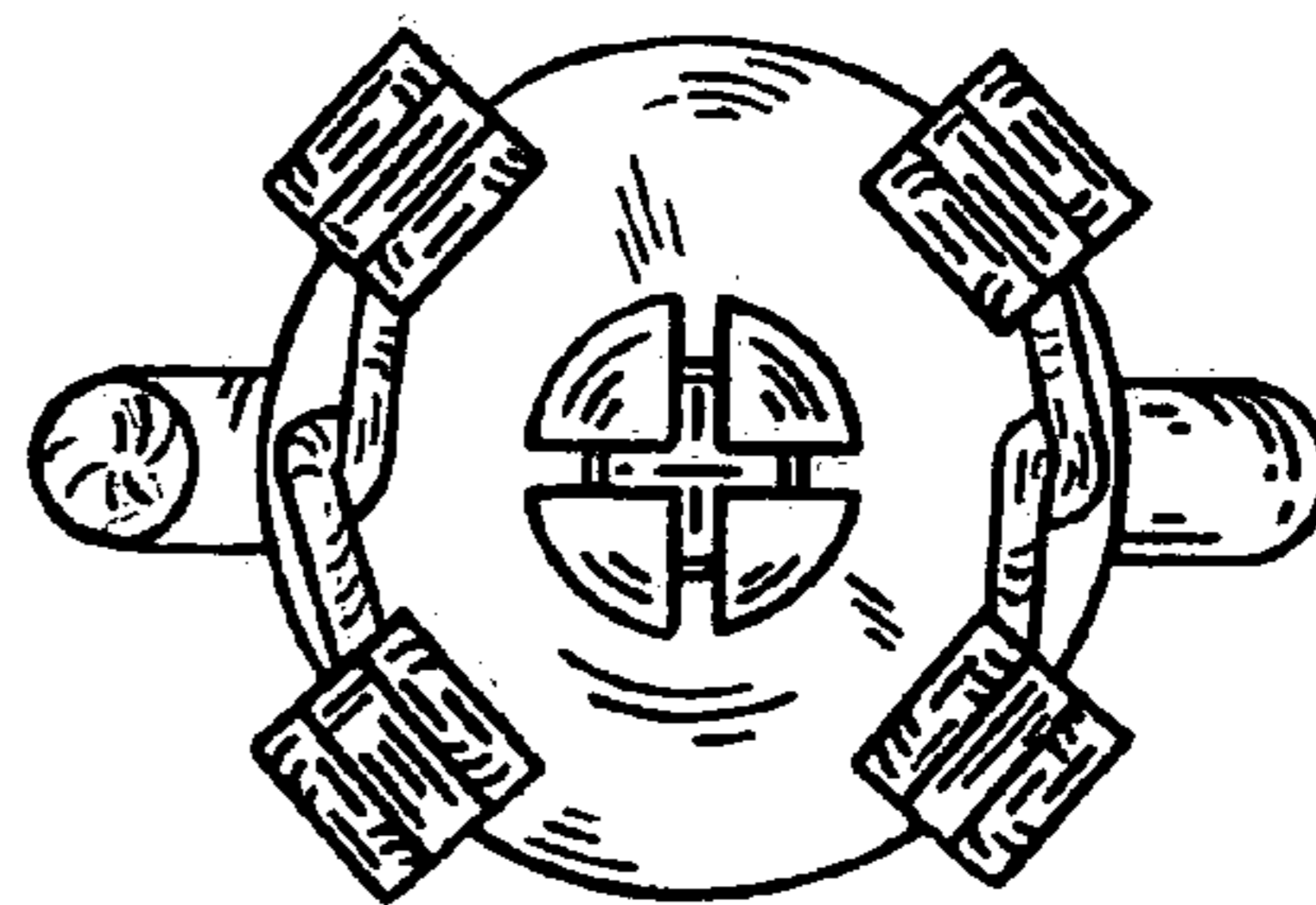

FIG. 9

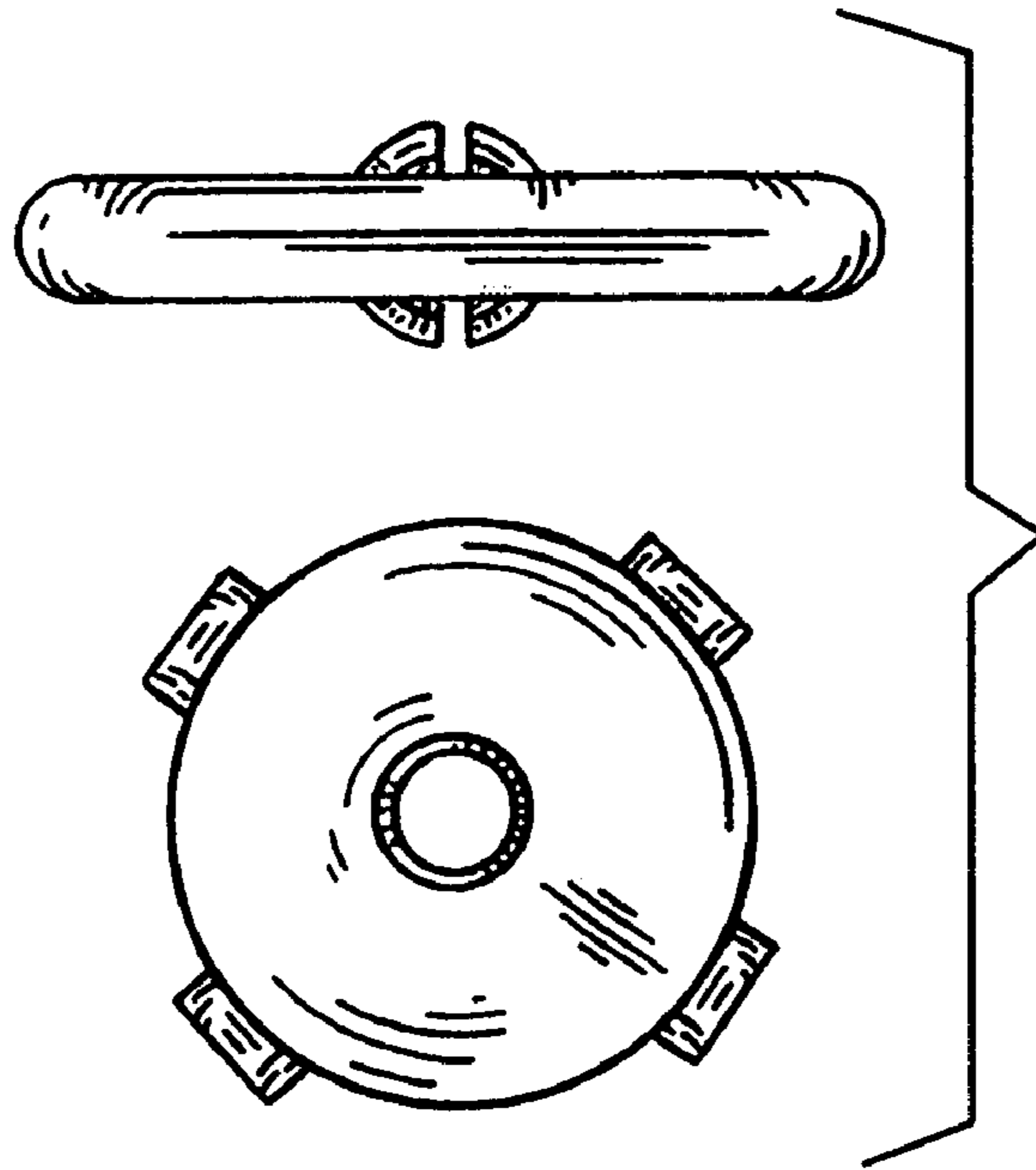

FIG. 10

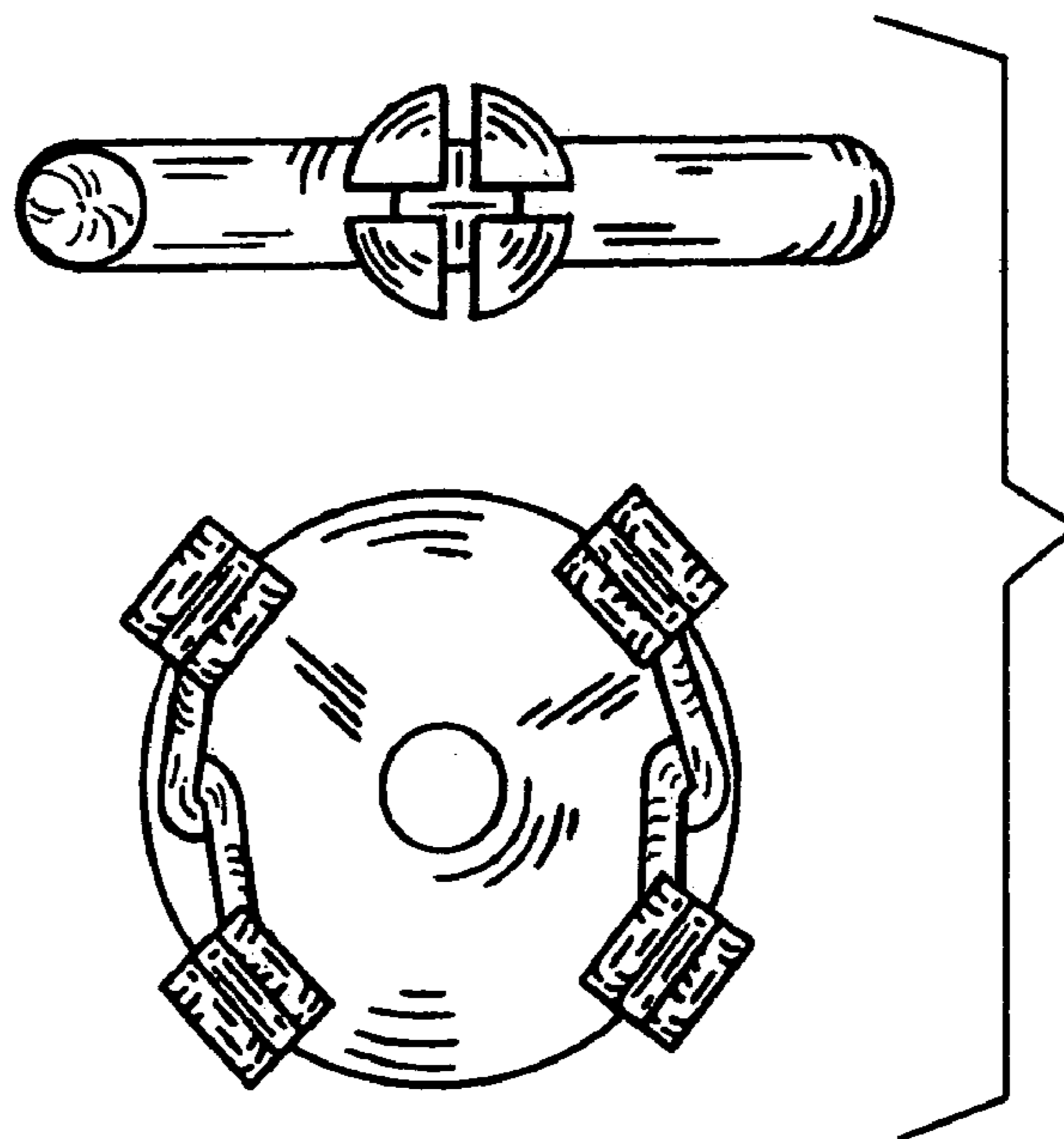

FIG. 11

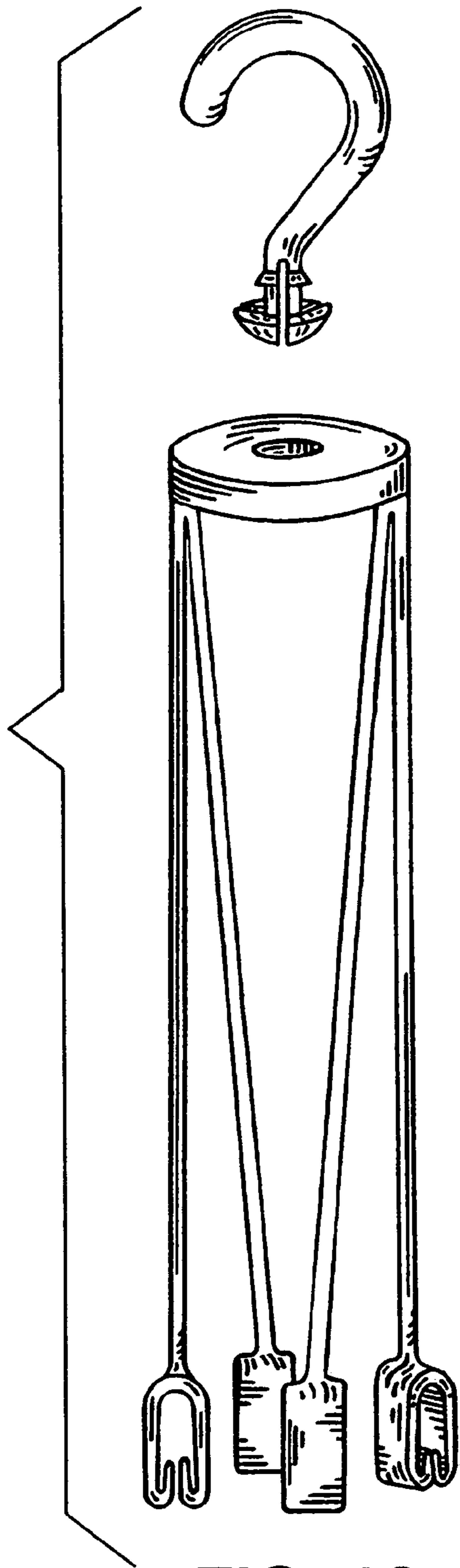

FIG. 12

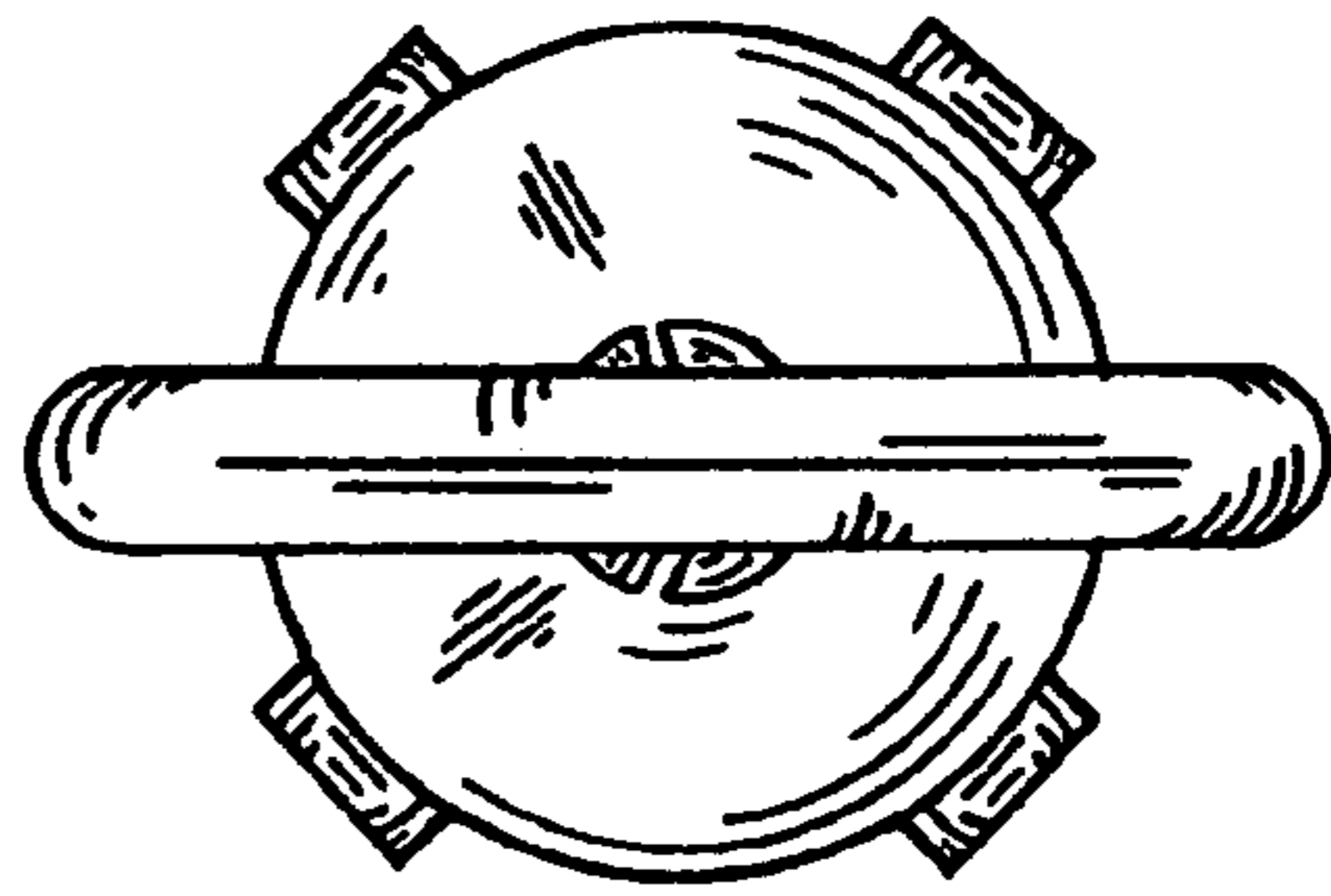

FIG. 13

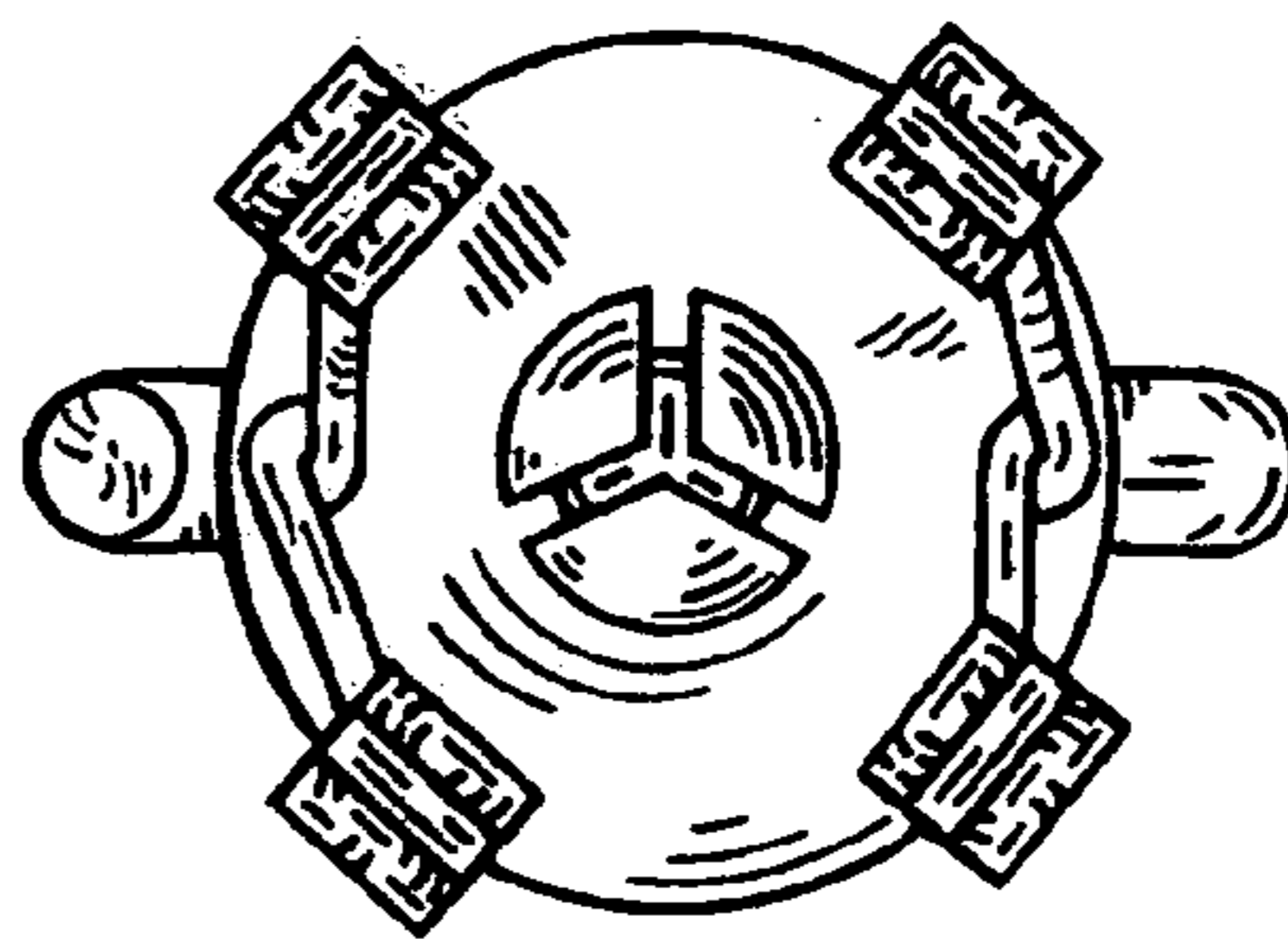

FIG. 14

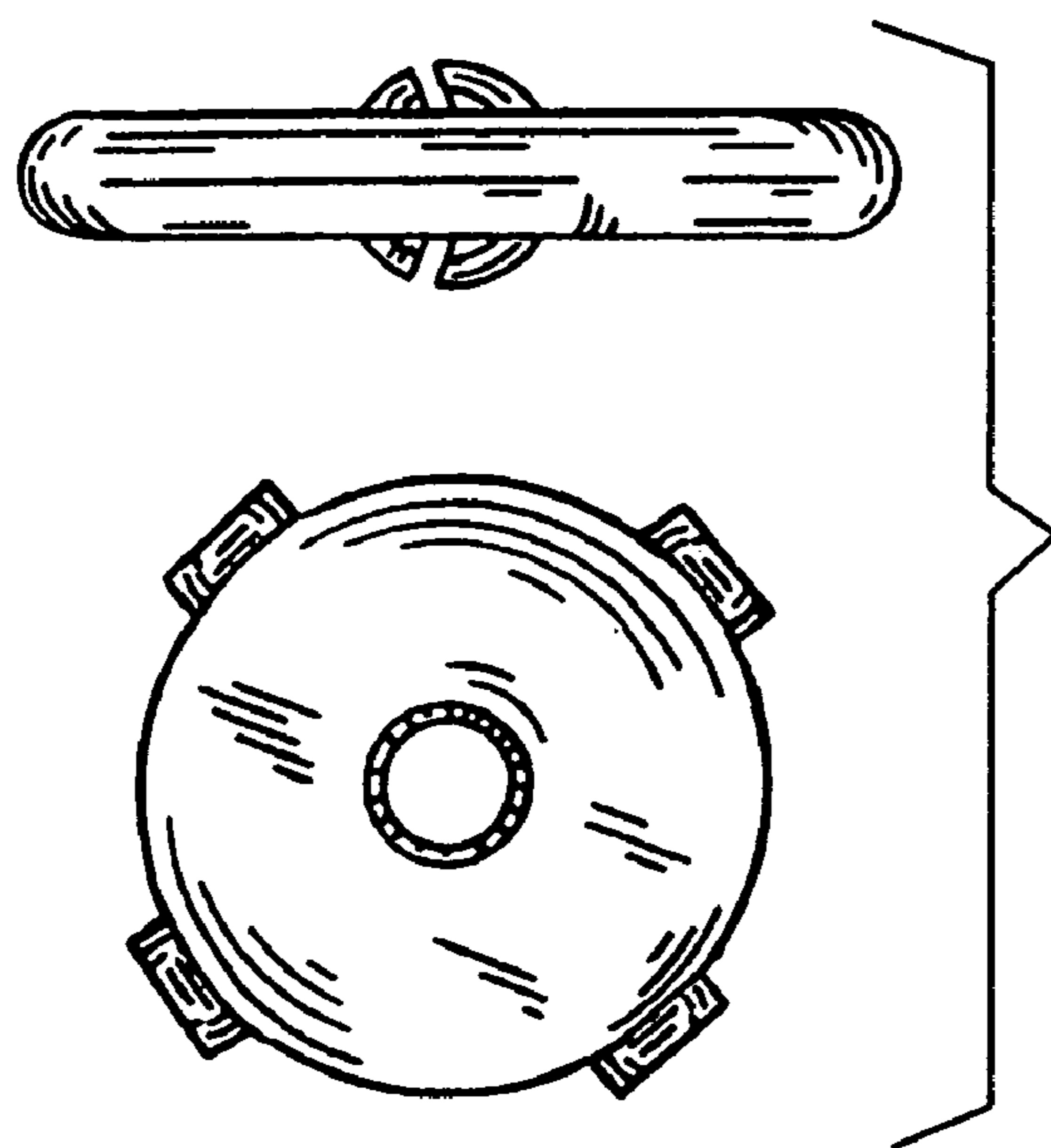

FIG. 15

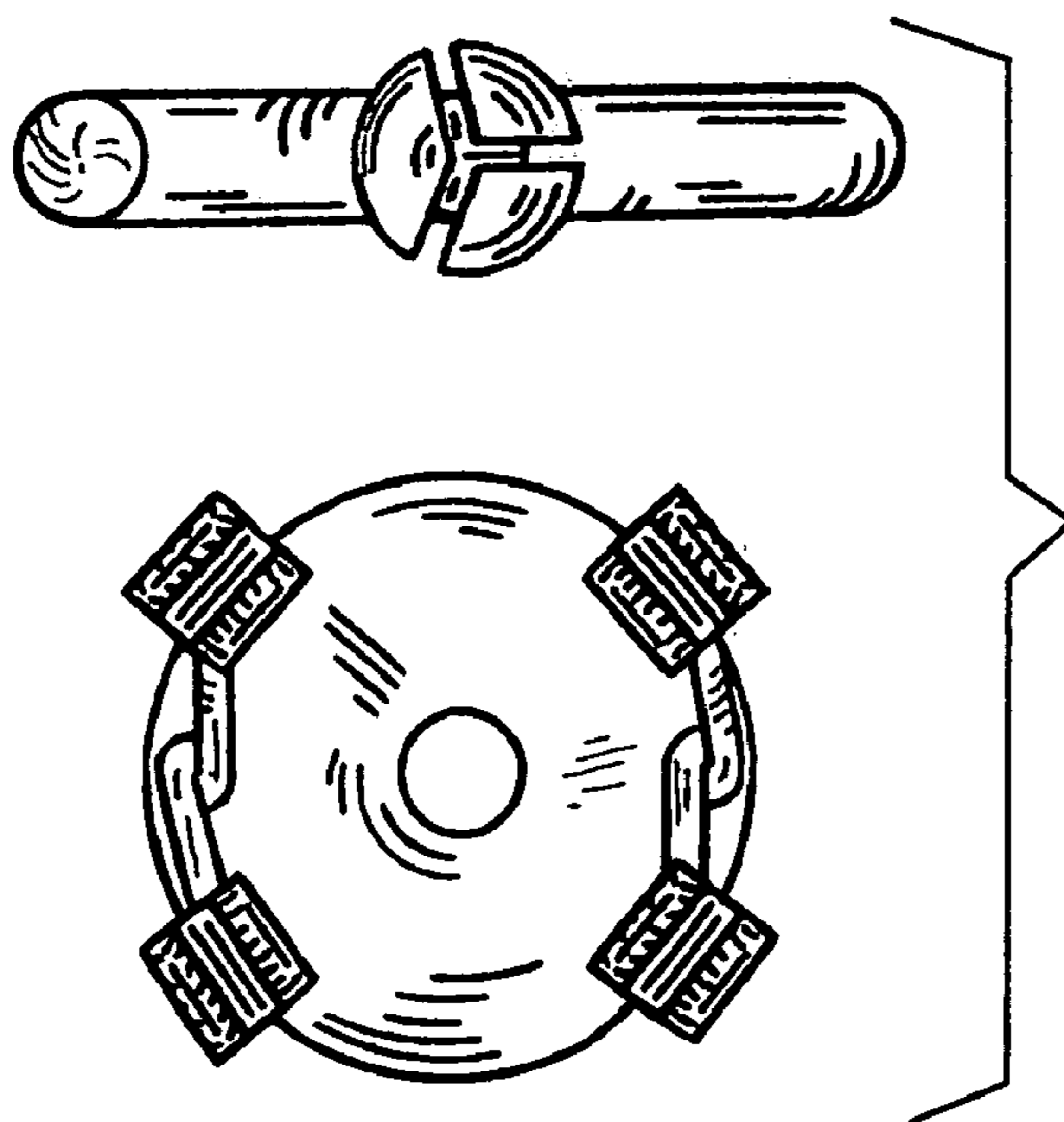

FIG. 16