



US00D630080S

(12) **United States Design Patent**  
**Seeds et al.**

(10) **Patent No.:** **US D630,080 S**  
(45) **Date of Patent:** **\*\* Jan. 4, 2011**

(54) **HANDLE FOR A MULTI-FUNCTION TOOL**

(75) Inventors: **Darrin Seeds**, Vancouver, WA (US);  
**John Nason**, Keizer, OR (US); **Hal Hardinge**, Tigard, OR (US)  
(73) Assignee: **Fiskars Brands, Inc.**, Madison, WI (US)  
(\*\*) Term: **14 Years**  
(21) Appl. No.: **29/362,615**  
(22) Filed: **May 27, 2010**

(51) **LOC (9) Cl.** ..... **08-03**  
(52) **U.S. Cl.** ..... **D8/105; D8/107**  
(58) **Field of Classification Search** ..... D8/99,  
D8/58, 55, 21, 356, 367, 52, 107, 105, 331,  
D8/4; D3/210; 81/440, 437, 124.4, 177.4,  
81/9.4; 7/138, 129, 128, 127, 125, 118; 30/155,  
30/161, 169, 236; 16/430, 429  
See application file for complete search history.

(56) **References Cited**

**U.S. PATENT DOCUMENTS**

2,478,696	A	8/1949	Isele	
4,238,862	A	12/1980	Leatherman	
4,744,272	A	5/1988	Leatherman	
D309,409	S *	7/1990	Kiernan	D8/4
4,942,637	A *	7/1990	Yeang-Yai	7/135
5,142,721	A	9/1992	Sessions et al.	
5,212,844	A	5/1993	Sessions et al.	
D367,807	S	3/1996	Hung	
5,564,318	A	10/1996	Pail	
5,664,274	A	9/1997	Collins	
5,697,114	A	12/1997	McIntosh et al.	

(Continued)

**FOREIGN PATENT DOCUMENTS**

EP 0 653 975 B1 10/2001

**OTHER PUBLICATIONS**

Gerber MP700, printed from website www.swords24, available at least as early as Aug. 6, 2009, 1 page.

(Continued)

*Primary Examiner*—Austin Murphy  
(74) *Attorney, Agent, or Firm*—Foley & Lardner LLP

(57) **CLAIM**

We claim the ornamental design for a handle for a multi-function tool, as shown and described.

**DESCRIPTION**

FIG. 1 is a perspective view of the claimed design.  
FIG. 2 is a right side view thereof.  
FIG. 3 is a left side view thereof.  
FIG. 4 is a front view thereof.  
FIG. 5 is a rear view thereof.  
FIG. 6 is a top view thereof.  
FIG. 7 is a bottom view thereof.  
FIG. 8 is a perspective view of the claimed design with a tool extended.  
FIG. 9 is a right side view thereof.  
FIG. 10 is a left side view thereof.  
FIG. 11 is a front view thereof.  
FIG. 12 is a rear view thereof.  
FIG. 13 is a top view thereof; and,  
FIG. 14 is a bottom view thereof.

The broken lines shown in the drawings represent unclaimed portions of the handle for a multi-function tool and unclaimed portions of the environment that form no part of the claimed design.

**1 Claim, 6 Drawing Sheets**

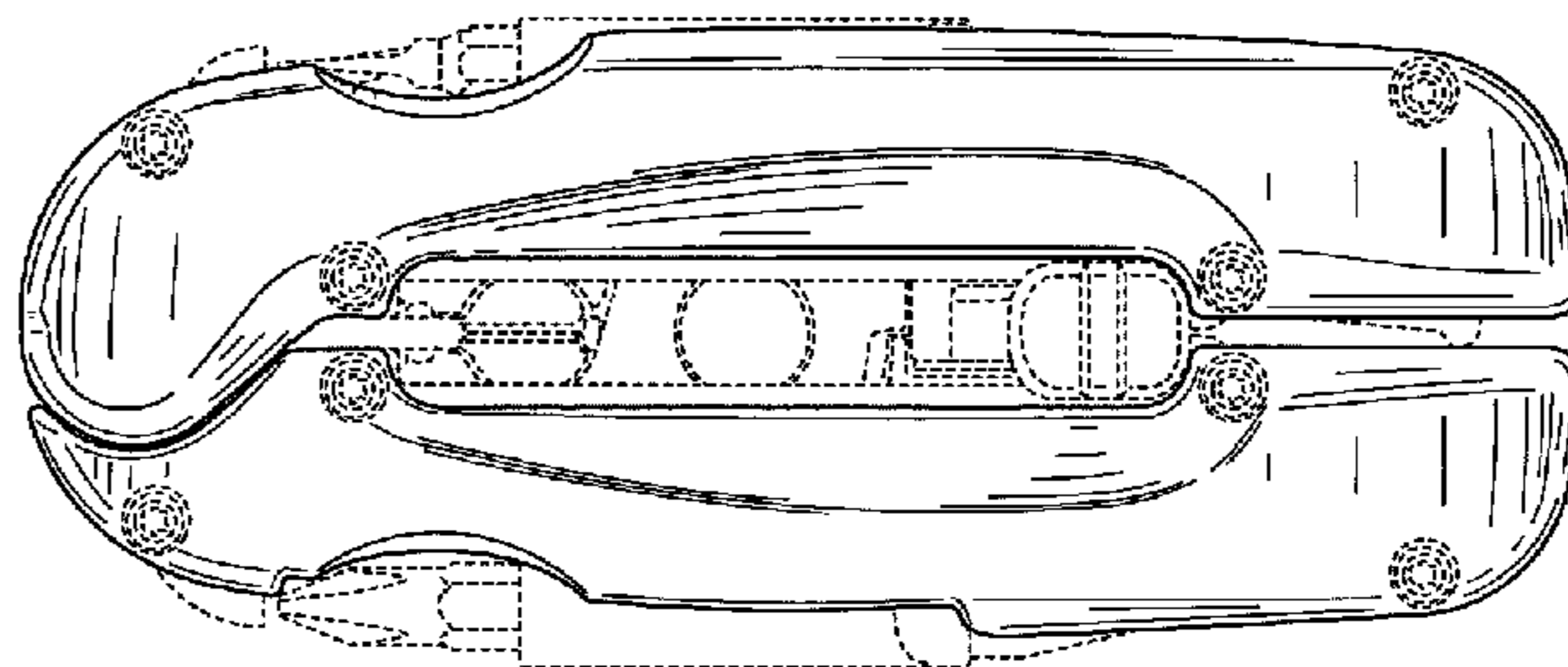
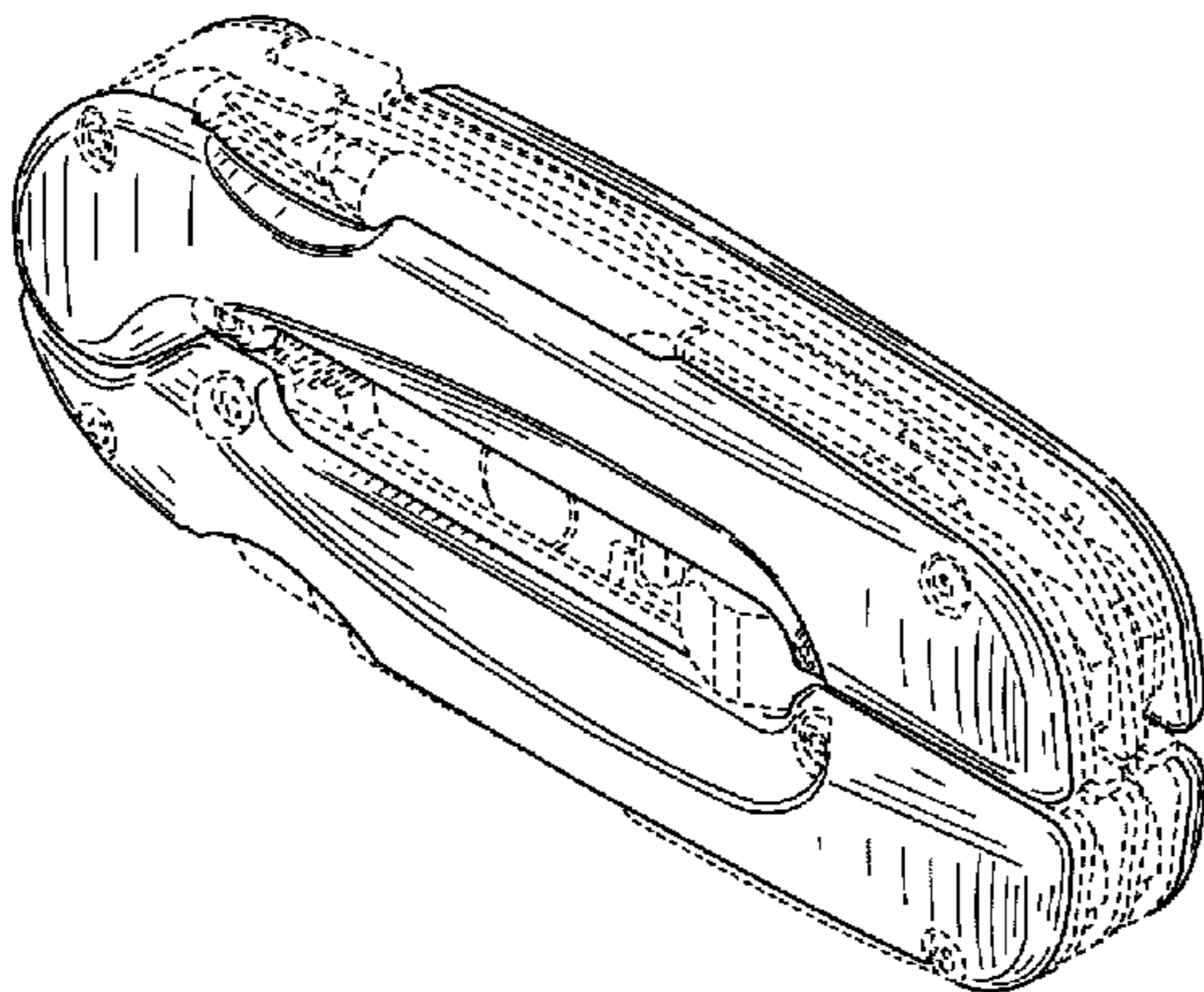

# US D630,080 S

## U.S. PATENT DOCUMENTS

D389,030	S	1/1998	Wensley		7,039,974	B2	5/2006	Berg
5,781,950	A	7/1998	Swinden et al.		7,063,435	B2	6/2006	Dallas et al.
5,916,277	A	6/1999	Dallas		D530,180	S *	10/2006	Klecker et al. .... D8/99
5,963,999	A	10/1999	Gardiner et al.		7,150,210	B2	12/2006	Berg et al.
D416,186	S *	11/1999	Balolia .....	D8/107	D535,171	S	1/2007	Ping
6,003,180	A	12/1999	Frazer		D541,618	S *	5/2007	Klecker .....
6,006,385	A	12/1999	Kershaw et al.		D551,050	S *	9/2007	Ping .....
6,009,582	A	1/2000	Harrison et al.		D553,467	S	10/2007	Ryan
6,023,805	A	2/2000	Lin		D555,455	S *	11/2007	Cheng .....
6,038,723	A	3/2000	Nabors et al.		D557,100	S	12/2007	Stokes et al.
D423,893	S *	5/2000	Mackin et al. ....	D8/52	7,347,128	B2	3/2008	Rivera et al.
6,088,860	A	7/2000	Poehlmann et al.		7,363,669	B2	4/2008	Berg et al.
6,108,845	A	8/2000	Hung et al.		D568,710	S	5/2008	Klecker et al.
D433,608	S	11/2000	Poehlmann et al.		D569,212	S *	5/2008	Hawk et al. ....
6,145,144	A	11/2000	Poehlmann et al.		D571,181	S	6/2008	Klecker et al.
6,185,771	B1	2/2001	Trusty, Sr.		D573,437	S	7/2008	Nenadic
6,219,870	B1	4/2001	Swinden et al.		D573,865	S	7/2008	Klecker et al.
6,223,374	B1	5/2001	Lin		7,406,896	B2 *	8/2008	Rivera .....
D445,326	S	7/2001	Alfaro		D592,931	S	5/2009	Nenadic
6,276,063	B1	8/2001	Chen		D595,103	S *	6/2009	Goodrich .....
6,282,996	B1	9/2001	Berg et al.		D600,527	S	9/2009	Nyssen et al.
D448,636	S *	10/2001	Yeh .....	D8/55	D600,528	S	9/2009	Nyssen et al.
6,305,041	B1	10/2001	Montague et al.		7,596,870	B2 *	10/2009	Klecker et al. ....
6,341,423	B1	1/2002	Taggart et al.		7,607,231	B2 *	10/2009	Klecker et al. ....
D454,044	S	3/2002	Alfaro		7,665,389	B2 *	2/2010	Frazer .....
6,405,395	B1	6/2002	Poehlmann et al.		7,712,399	B2 *	5/2010	Nenadic .....
D467,783	S	12/2002	Onion		7,730,811	B2 *	6/2010	Robinson et al. ....
6,487,941	B1	12/2002	Ping		2001/0014986	A1 *	8/2001	Harrison .....
D469,328	S *	1/2003	Ping .....	D8/107	2002/0023302	A1 *	2/2002	Montague et al. ....
6,523,203	B2	2/2003	Harrison		2004/0000058	A1 *	1/2004	Shyr .....
6,594,906	B1	7/2003	Sakai et al.		2004/0003472	A1	1/2004	Dallas et al.
6,622,328	B2	9/2003	Rivera		2004/0019974	A1 *	2/2004	Montague et al. ....
6,625,832	B2	9/2003	Montague et al.		2004/0031105	A1 *	2/2004	Berg .....
D480,940	S	10/2003	Dallas		2005/0193498	A1 *	9/2005	Klecker et al. ....
D480,941	S	10/2003	Dallas		2010/0122420	A1 *	5/2010	Nason et al. ....
D481,289	S	10/2003	Dallas					
6,643,877	B1	11/2003	Antenbrink et al.					
6,691,357	B2	2/2004	Rivera					
D488,700	S	4/2004	Montague					
6,721,984	B1	4/2004	Harrison					
D493,685	S	8/2004	Dallas					
D505,057	S	5/2005	Ralph					
D515,903	S	2/2006	Kelleghan					
7,000,323	B1	2/2006	Hatcher et al.					
7,028,591	B2	4/2006	Dallas et al.					

## OTHER PUBLICATIONS

Skeletool® CX, printed from website [www.leatherman.com](http://www.leatherman.com), available at least as early as Aug. 6, 2009, 1 page.  
 Freestyle™ CX, printed from website [www.leatherman.com](http://www.leatherman.com), available at least as early as Aug. 6, 2009, 1 page.  
 SL™ Plier, Toollogic, Built for Life, printed from website [www.toollogic.com](http://www.toollogic.com), available at least as early as Aug. 6, 2009, 1 page.  
 U.S. Appl. No. 29/335,234, filed Apr. 10, 2009, Freeman et al.  
 U.S. Appl. No. 12/274,850, filed Nov. 20, 2008, Nason et al.

\* cited by examiner

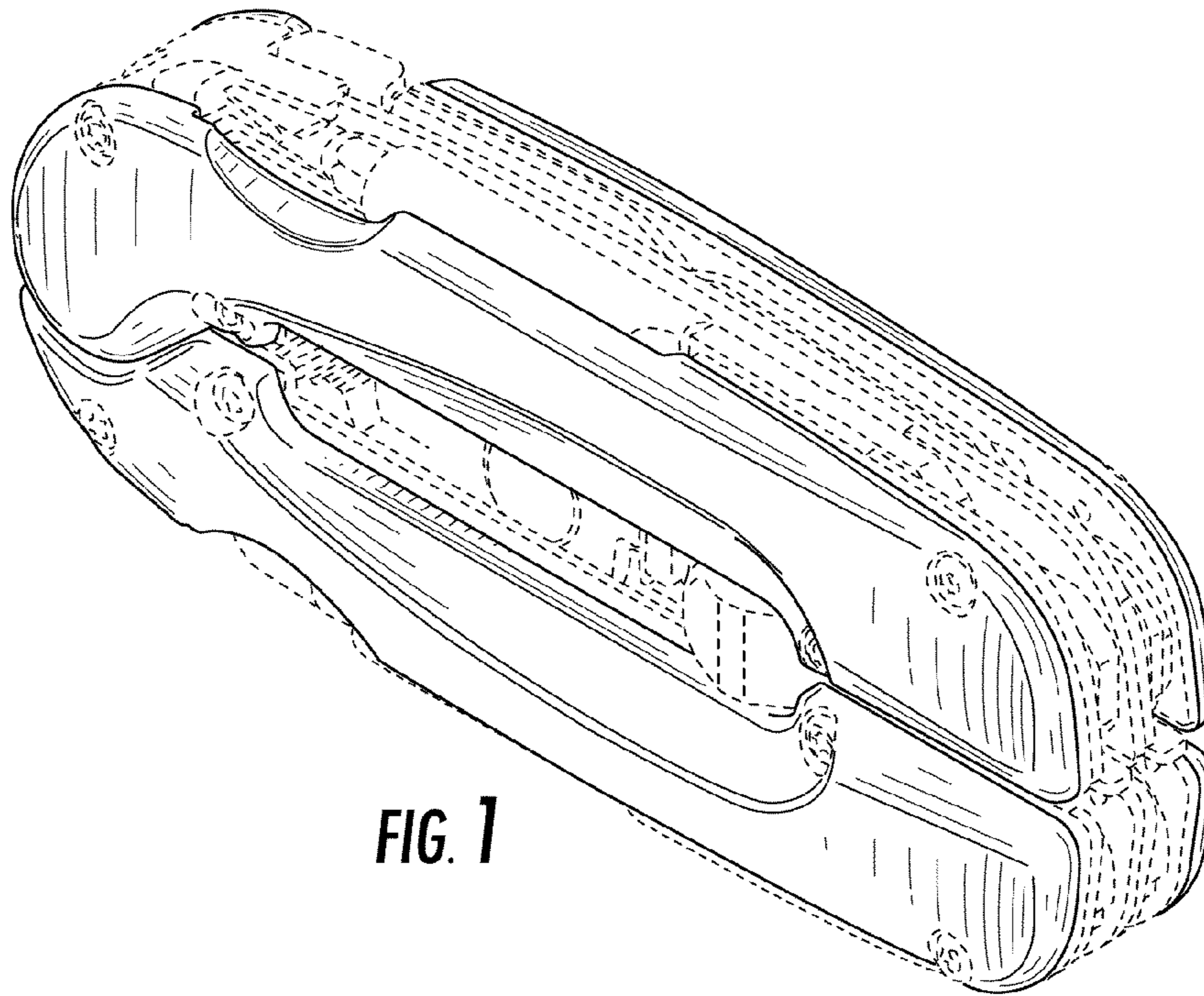

**FIG. 1**

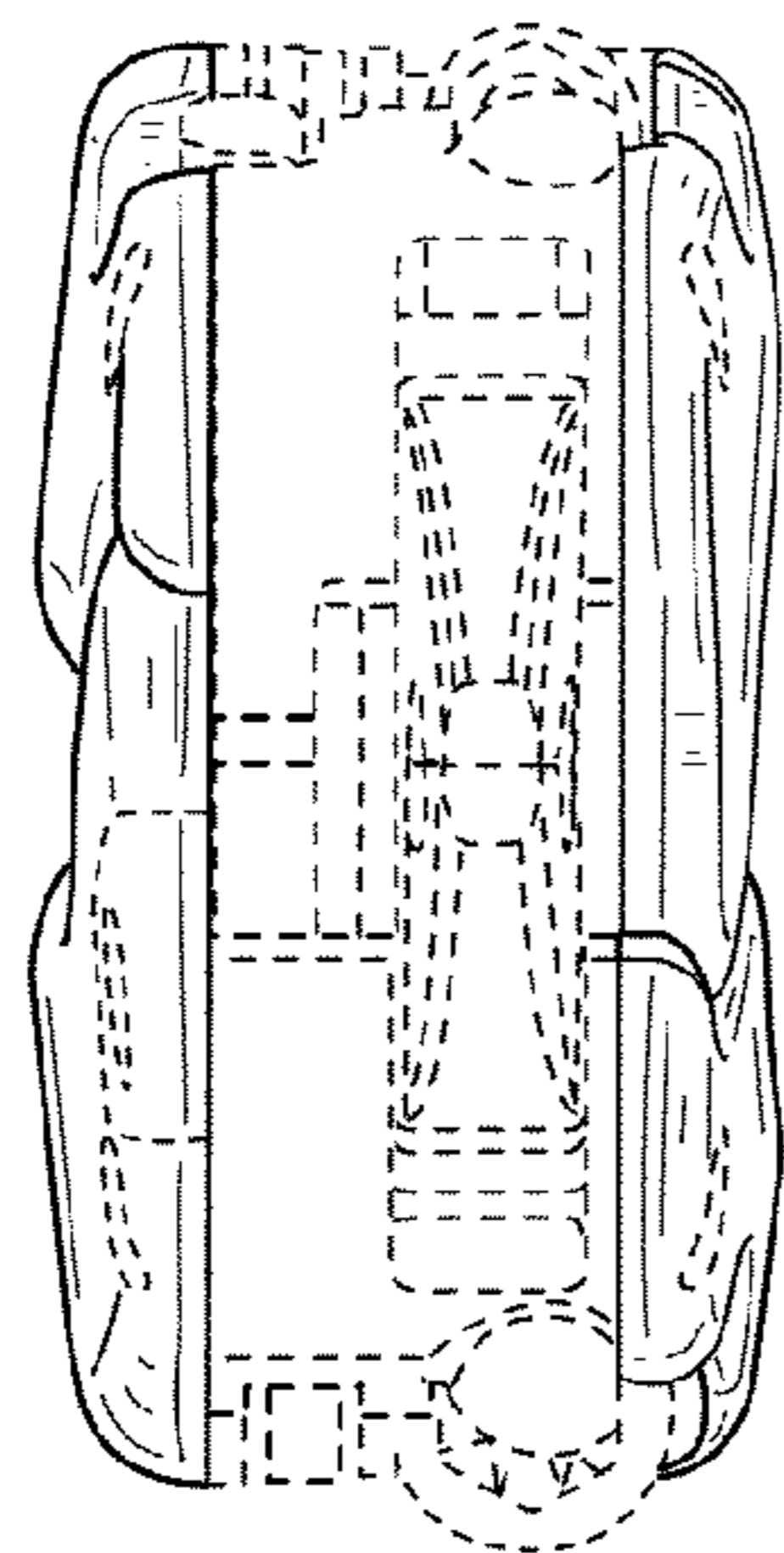

**FIG. 4**

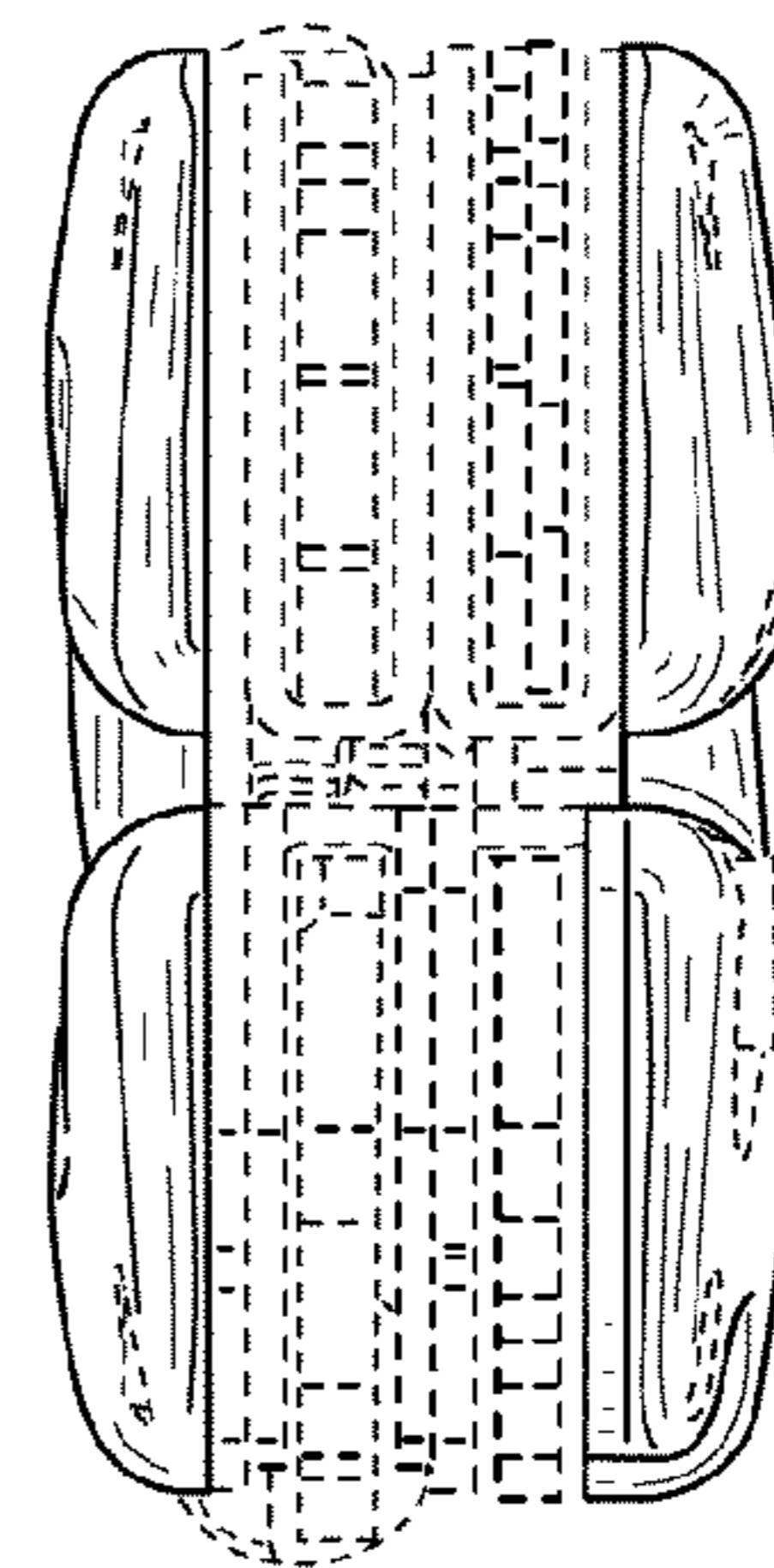

**FIG. 5**

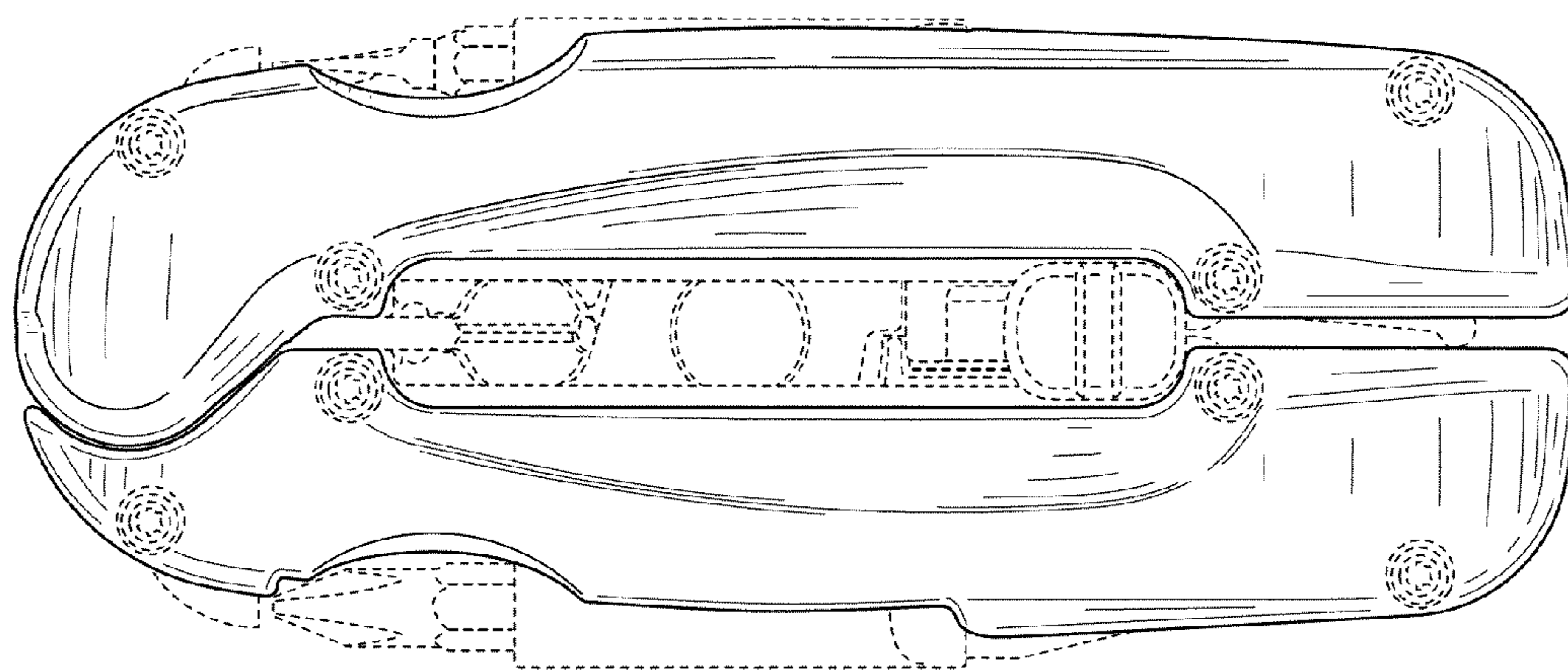

FIG. 2

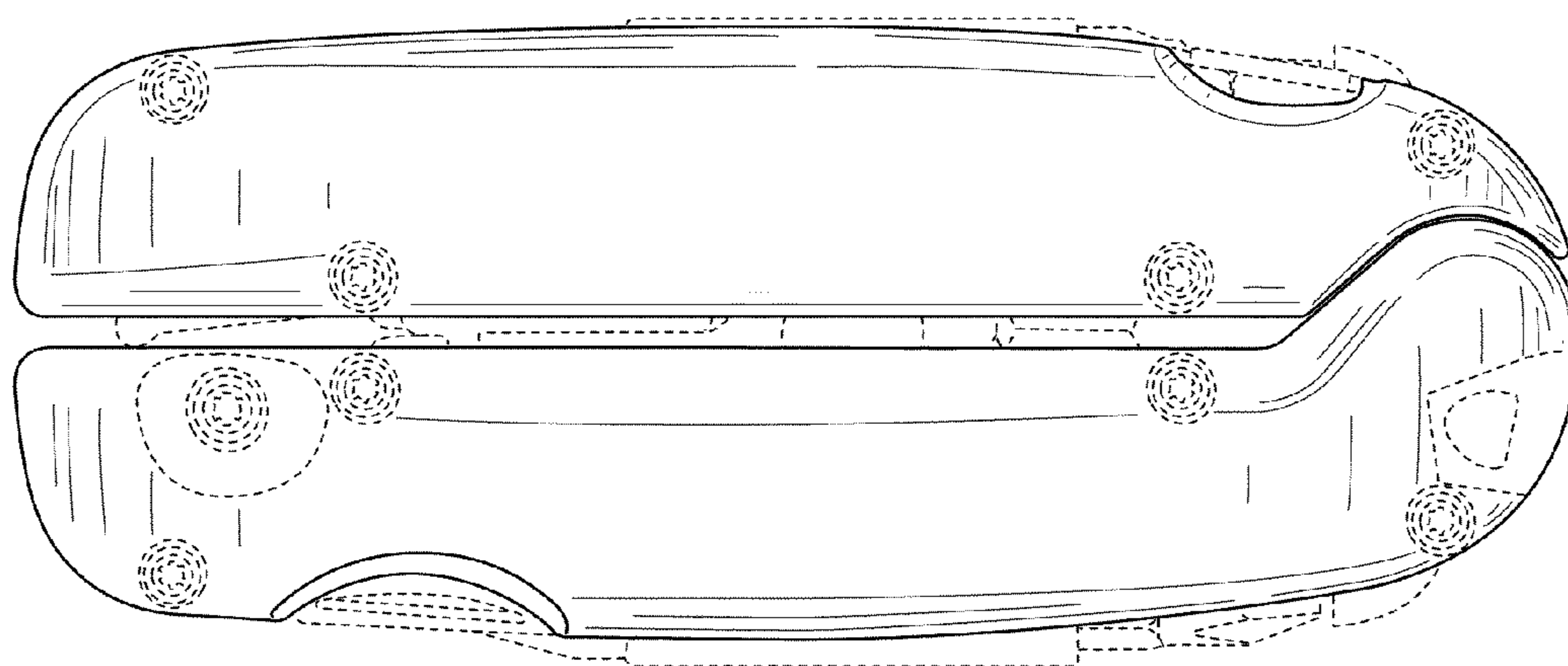

FIG. 3

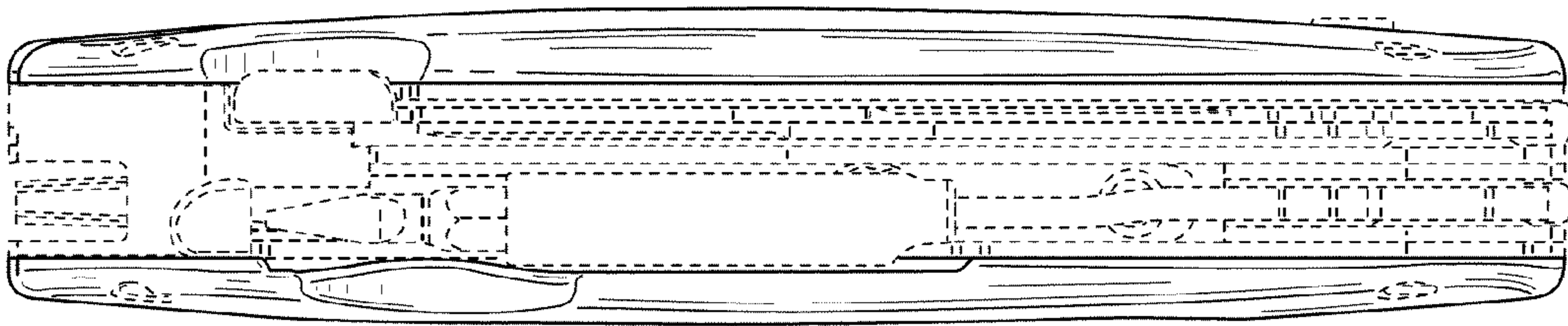

FIG. 6

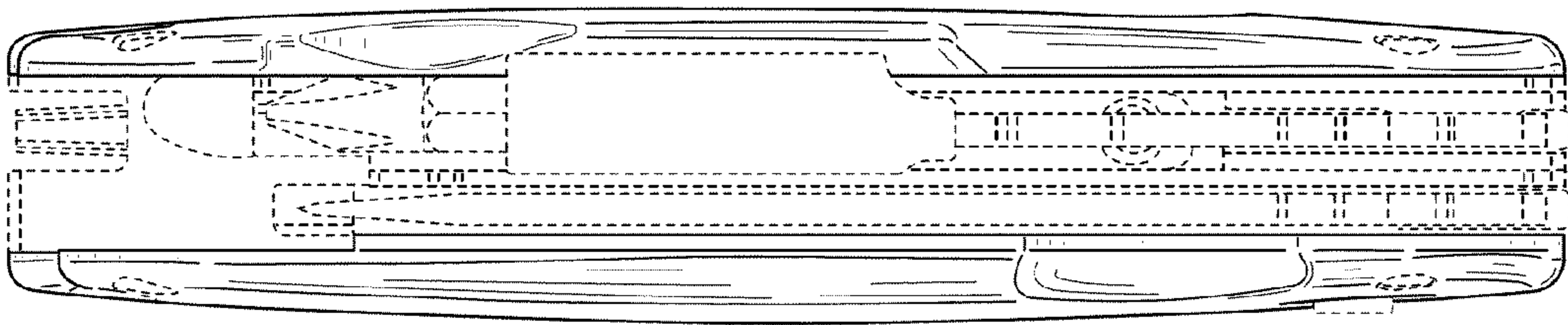
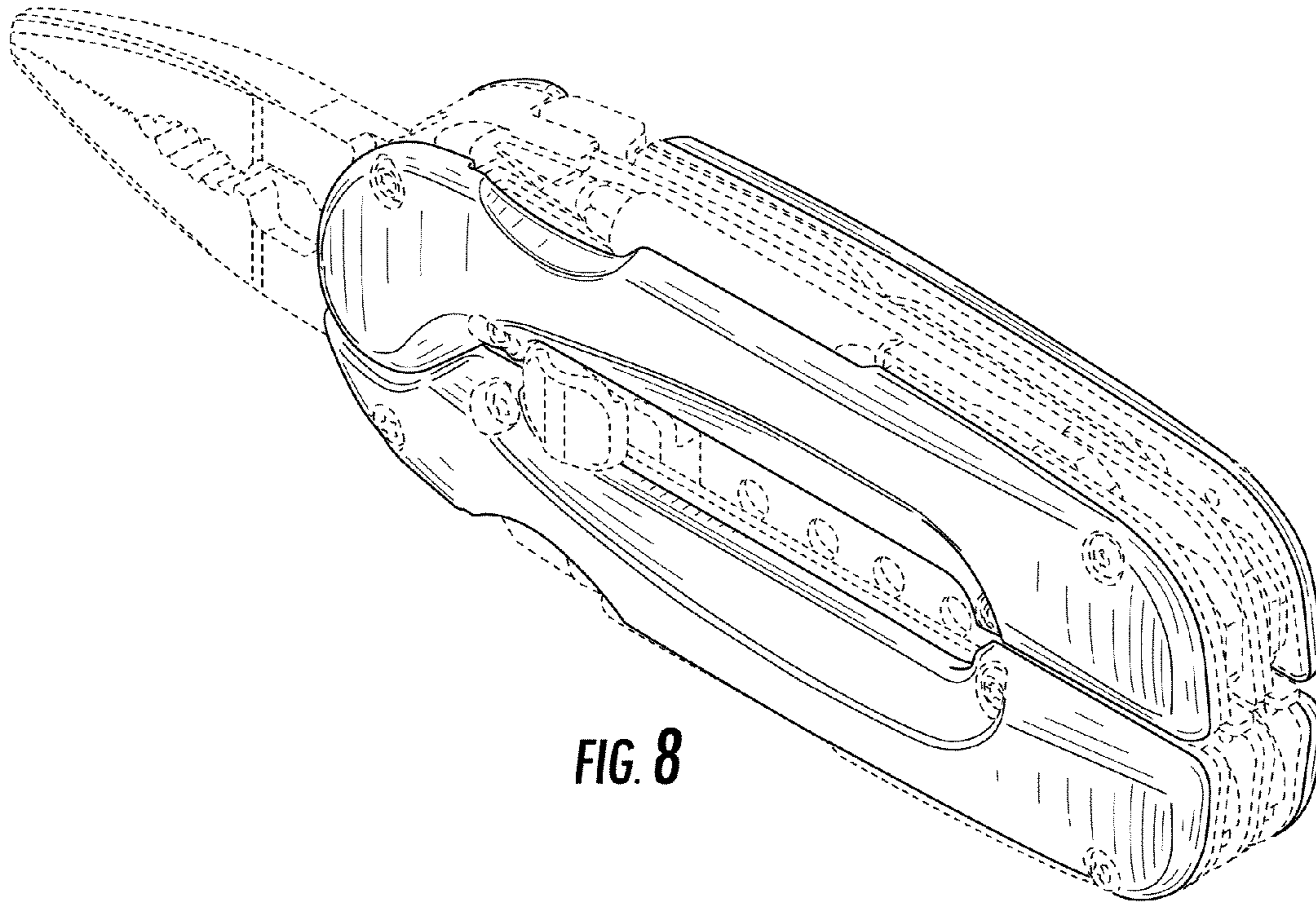
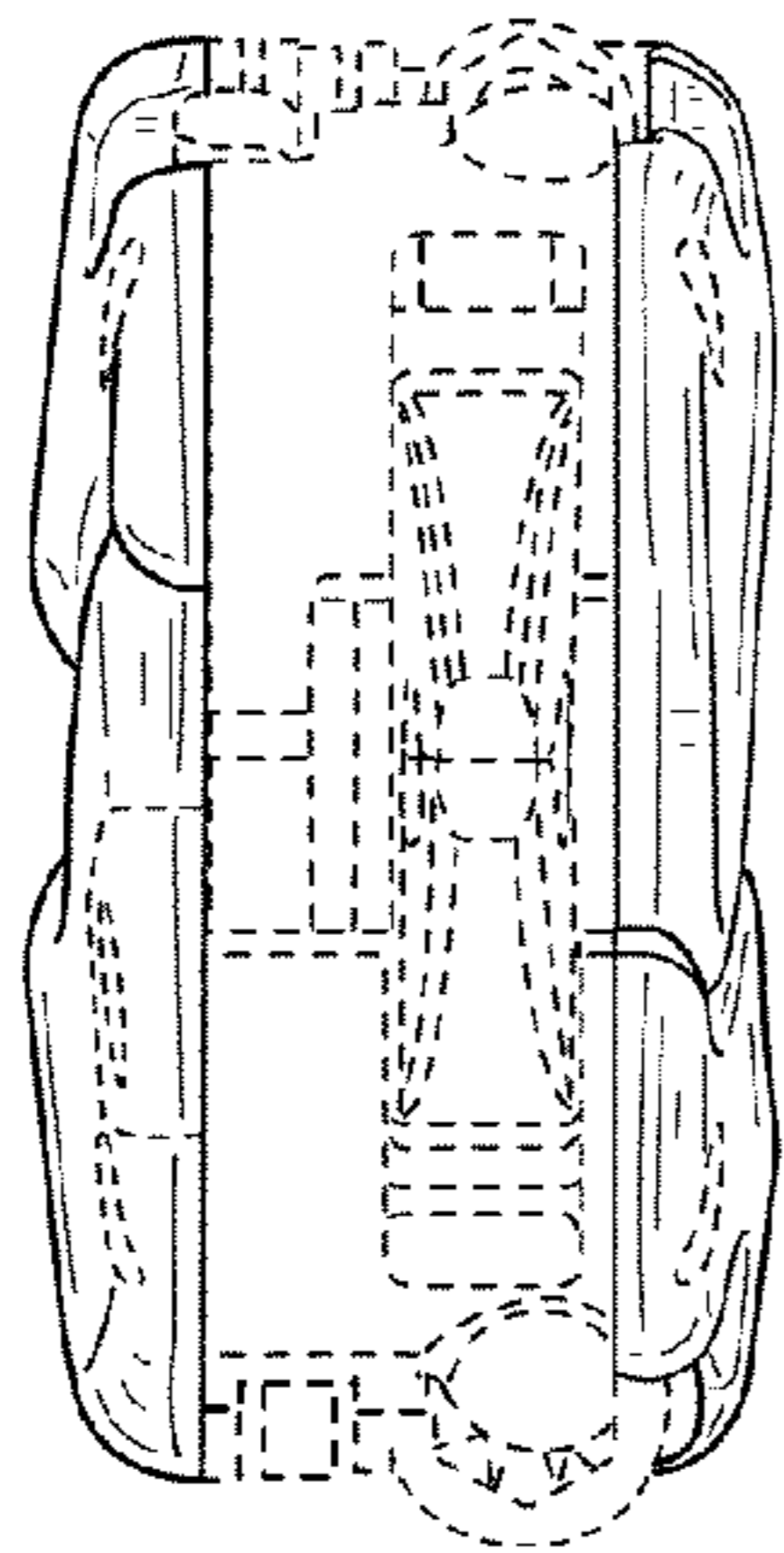

FIG. 7



**FIG. 8**



**FIG. 11**

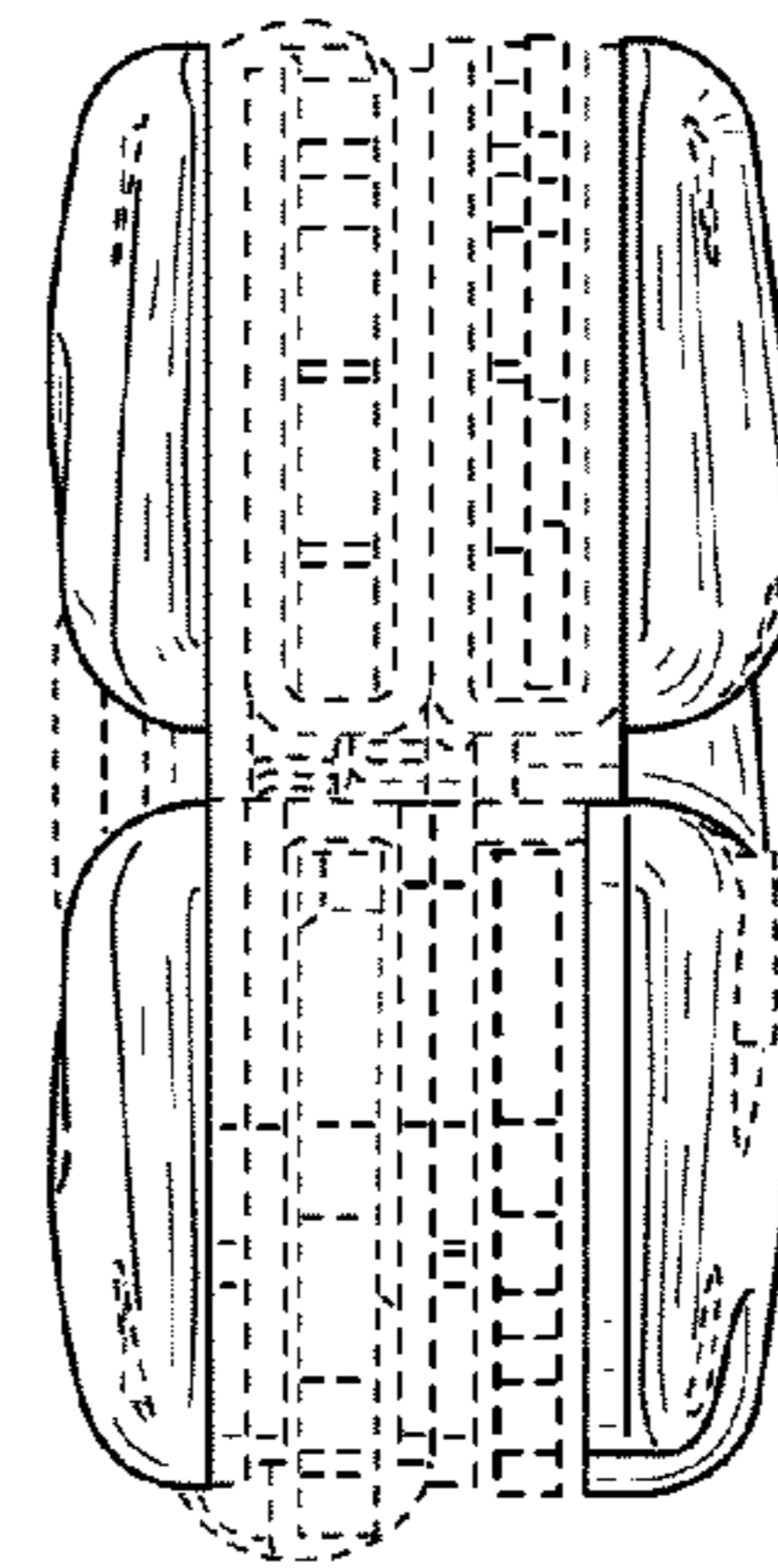

**FIG. 12**

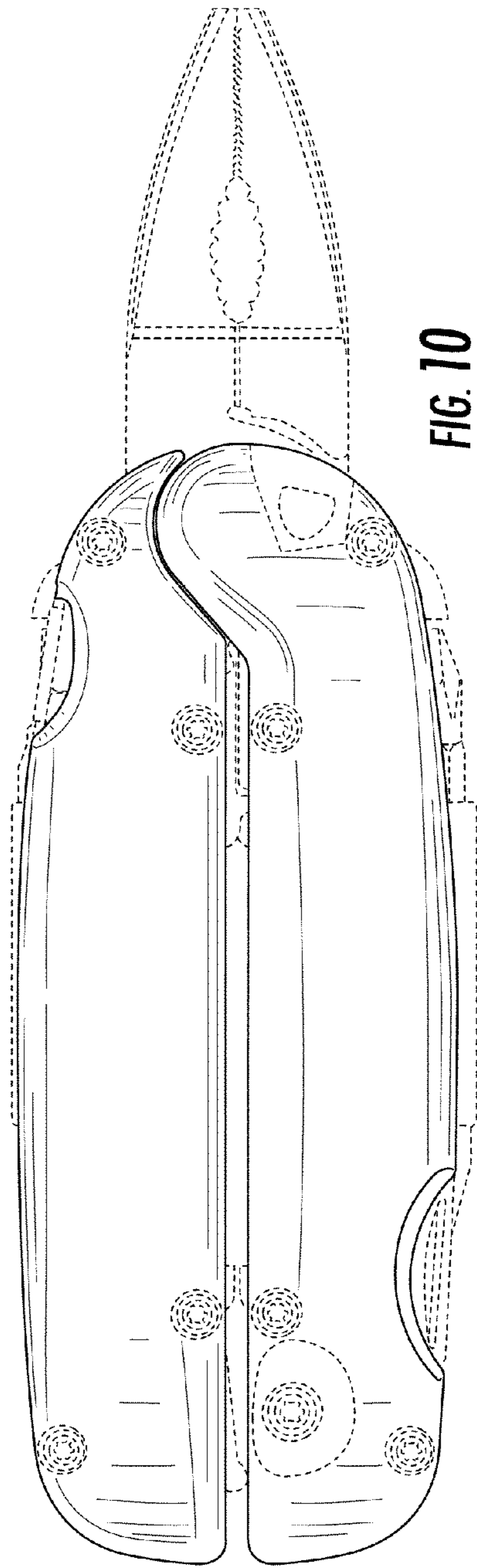
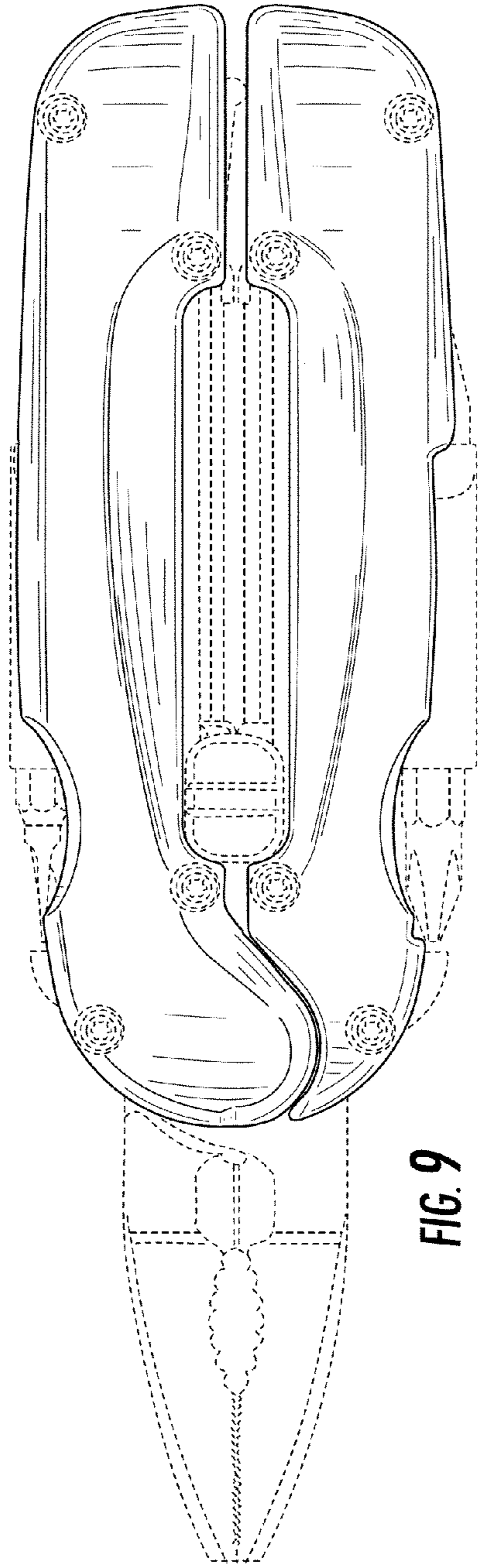

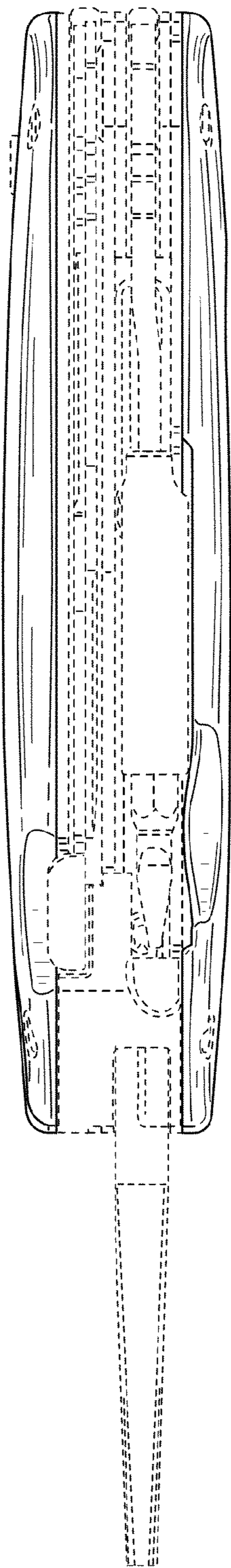

FIG. 13

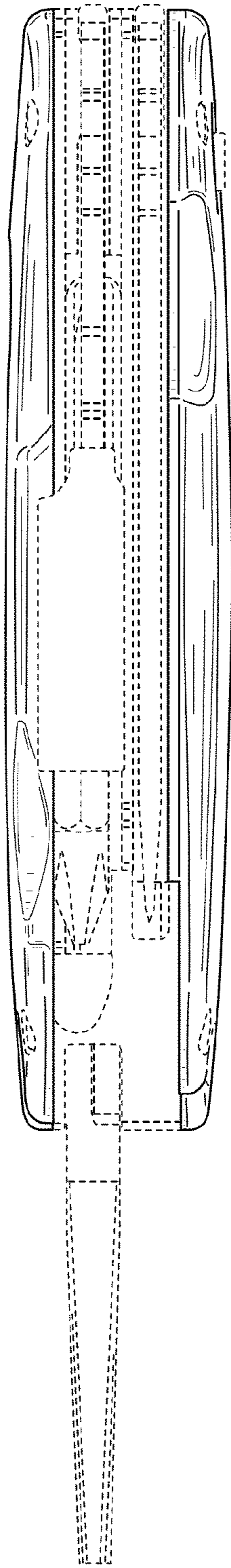

FIG. 14