



US00D629991S

(12) **United States Design Patent**
Day et al.

(10) **Patent No.:** **US D629,991 S**
(45) **Date of Patent:** **** Dec. 28, 2010**

(54) **IRON**

(75) Inventors: **Adam Day**, Boynton Beach, FL (US);
Raul Chinda, Fort Lauderdale, FL (US)

(73) Assignee: **Sunbeam Products, Inc.**, Boca Raton,
FL (US)

(**) Term: **14 Years**

(21) Appl. No.: **29/369,353**

(22) Filed: **Sep. 7, 2010**

(51) **LOC (9) Cl.** **07-05**

(52) **U.S. Cl.** **D32/70**

(58) **Field of Classification Search** D32/73,
D32/72, 71, 70, 69, 68, 35; 392/404; 38/97,
38/96, 93, 88, 77.9, 77.83, 77.82, 77.81,
38/77.8, 77.7, 77.6, 77.5, 77.3, 77.1; 219/251,
219/245

See application file for complete search history.

(56) **References Cited**

U.S. PATENT DOCUMENTS

- D388,920 S * 1/1998 Nitsch D32/70
- D393,509 S * 4/1998 Gudfin D32/70
- D413,005 S * 8/1999 Taylor D32/70
- D428,541 S * 7/2000 Bas D32/70
- D434,197 S * 11/2000 Perko et al. D32/70
- D441,930 S * 5/2001 Choi D32/70
- D464,779 S * 10/2002 Garman D32/70
- D470,636 S * 2/2003 Bas D32/70
- D476,124 S * 6/2003 Garman D32/70
- D476,453 S * 6/2003 Garman D32/70
- D478,401 S * 8/2003 Lee D32/70

- D509,936 S * 9/2005 Barquin Santillan D32/70
- D516,764 S * 3/2006 Kihara D32/70
- D530,474 S * 10/2006 Barquin Santillan D32/70
- D530,872 S * 10/2006 Barquin Santillan et al. . D32/70
- D530,873 S * 10/2006 Poon D32/70
- D531,369 S * 10/2006 Archer et al. D32/70
- D531,371 S * 10/2006 Barquin Santillan et al. . D32/70
- D531,775 S * 11/2006 Barquin Santillan D32/70
- D537,595 S * 2/2007 Picozza et al. D32/70
- D538,498 S * 3/2007 Picozza et al. D32/70
- D555,314 S * 11/2007 Leslie et al. D32/70
- D580,119 S * 11/2008 Pino et al. D32/70
- D594,165 S * 6/2009 Mizoguchi D32/70
- D594,166 S * 6/2009 Mizoguchi D32/70

* cited by examiner

Primary Examiner—Austin Murphy

(74) *Attorney, Agent, or Firm*—Michael J. Corrigan

(57) **CLAIM**

The ornamental design for an iron, as shown and described.

DESCRIPTION

FIG. 1 is a front perspective view of an iron;

FIG. 2 is left side view thereof;

FIG. 3 is a right side view thereof;

FIG. 4 is a front side view thereof;

FIG. 5 is a rear side view thereof;

FIG. 6 is a top plan view thereof; and,

FIG. 7 is a bottom plan view thereof.

The broken lines shown in the drawings represent portions of the iron that form no part of the claimed design.

1 Claim, 7 Drawing Sheets

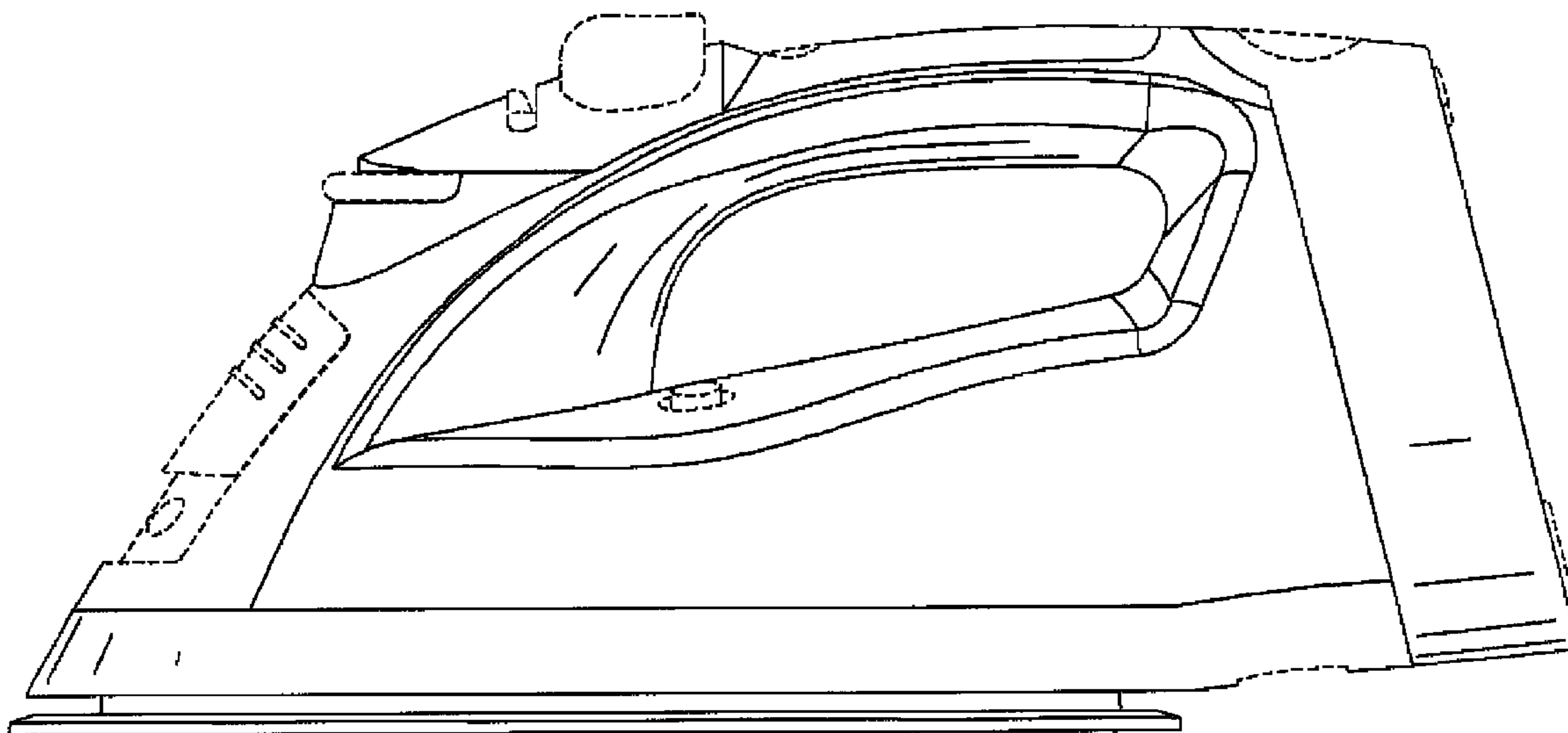

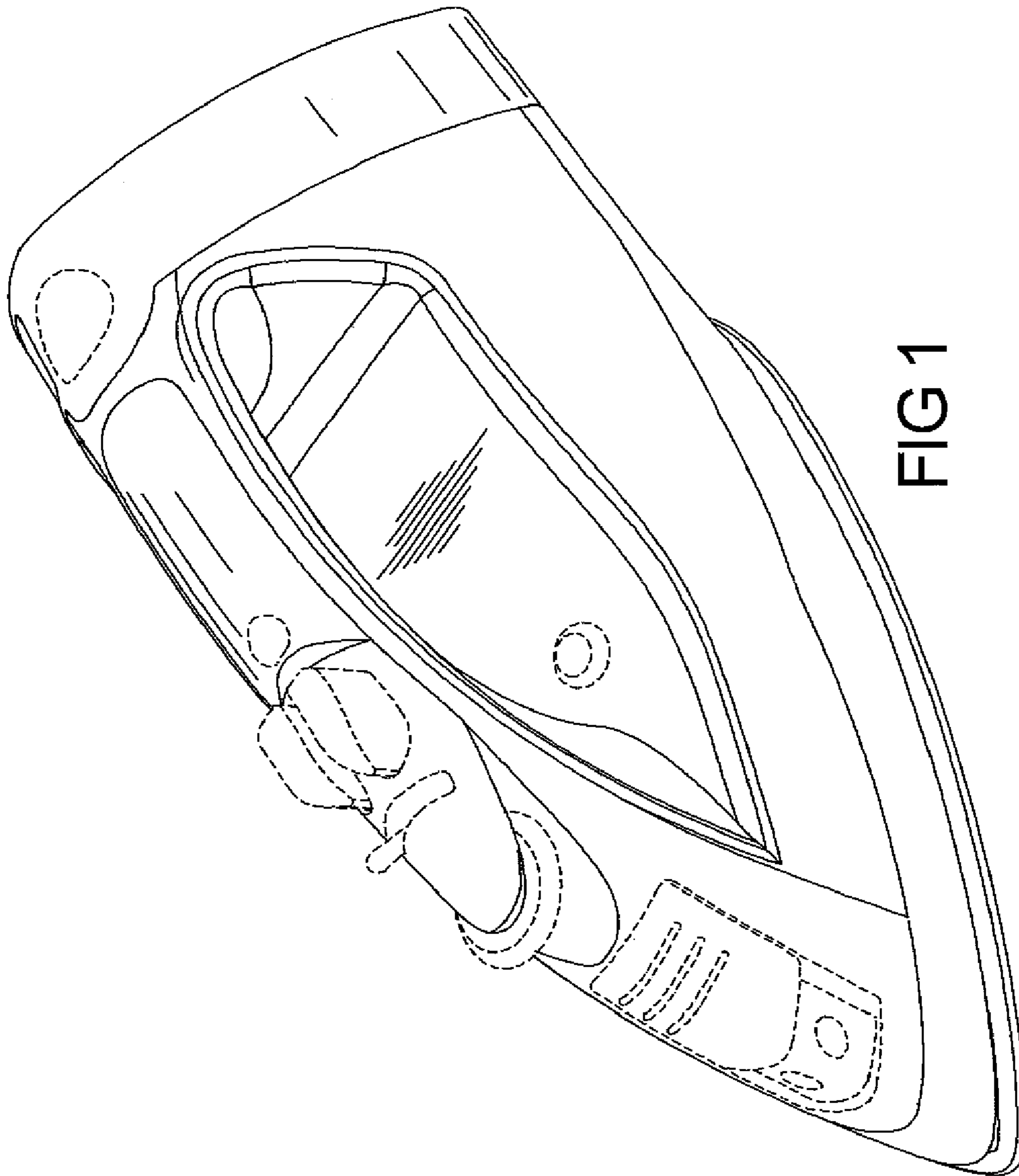

FIG 1

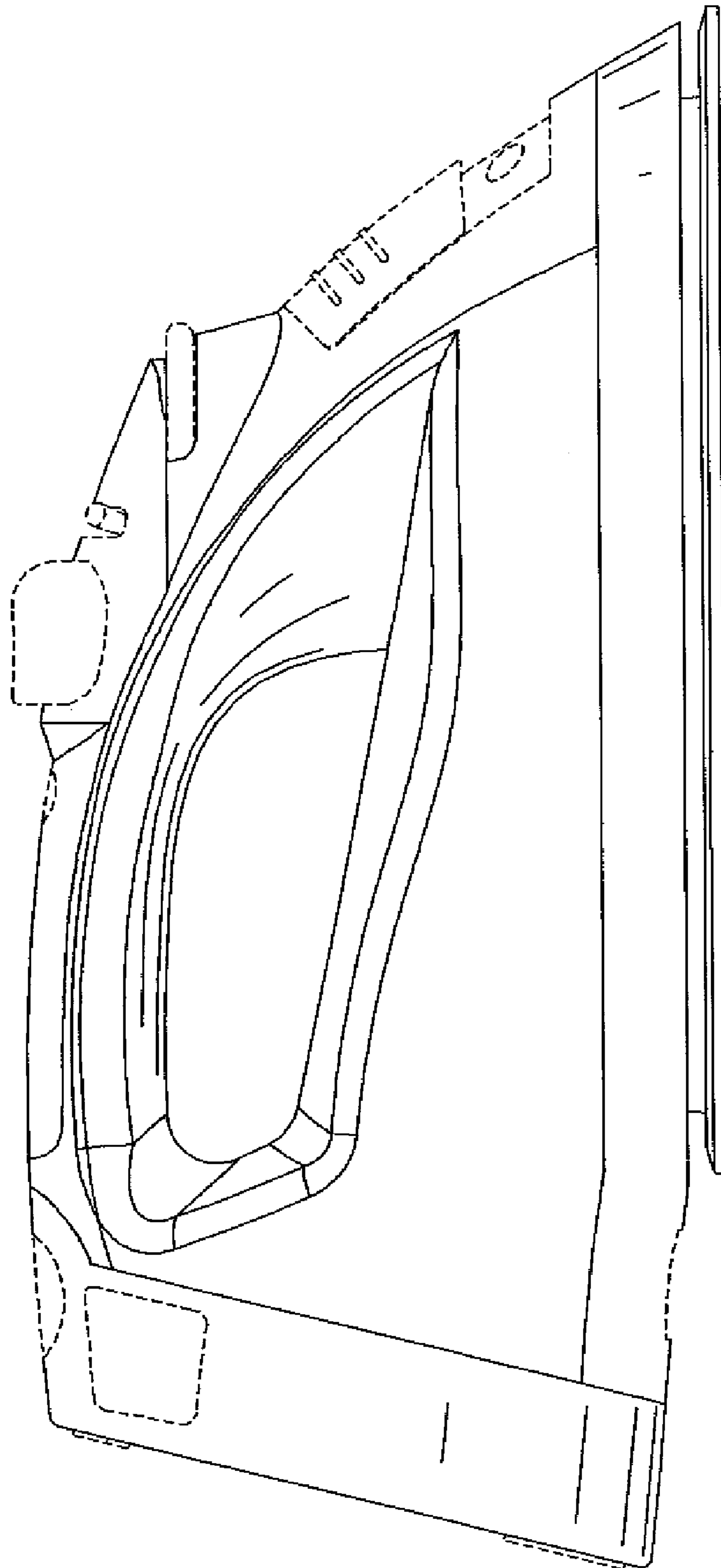

FIG 2

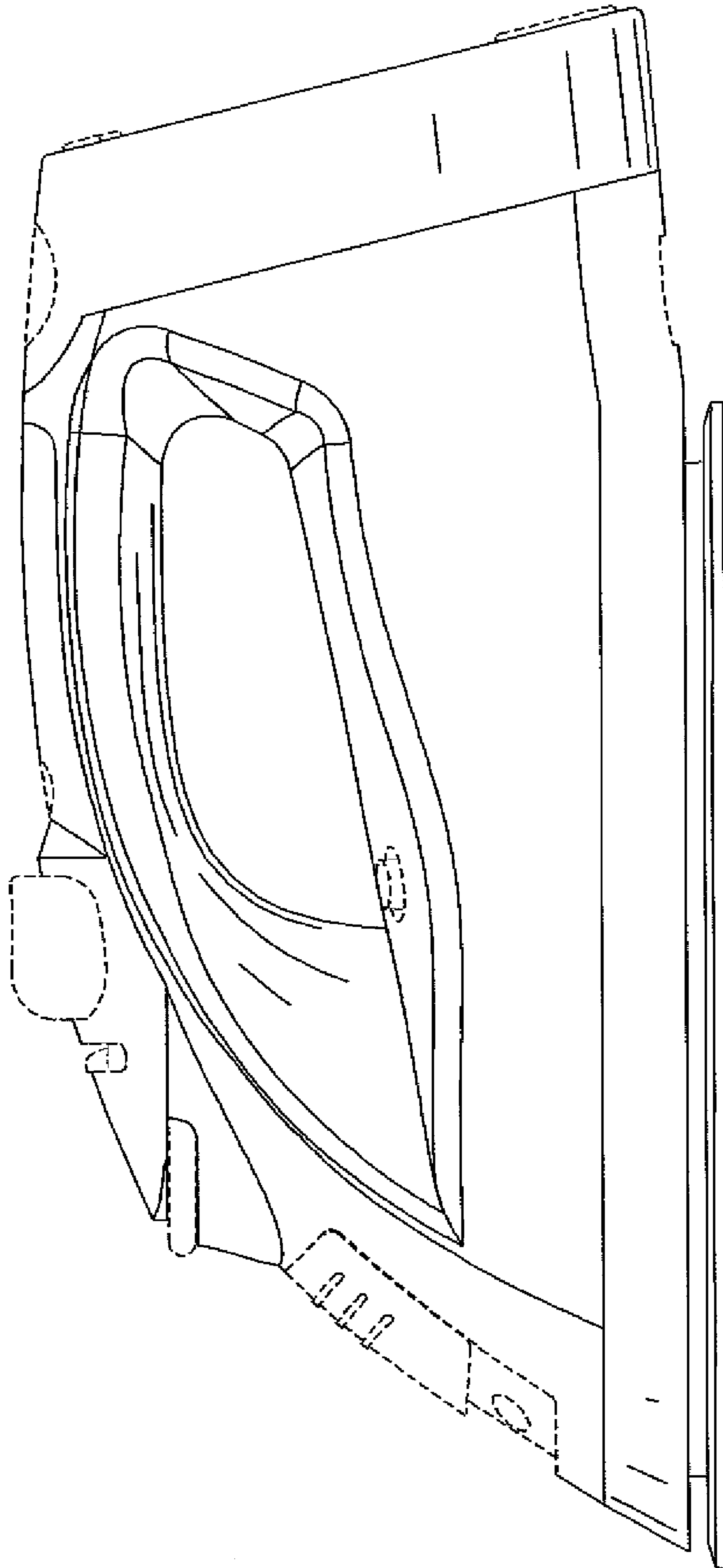

FIG 3

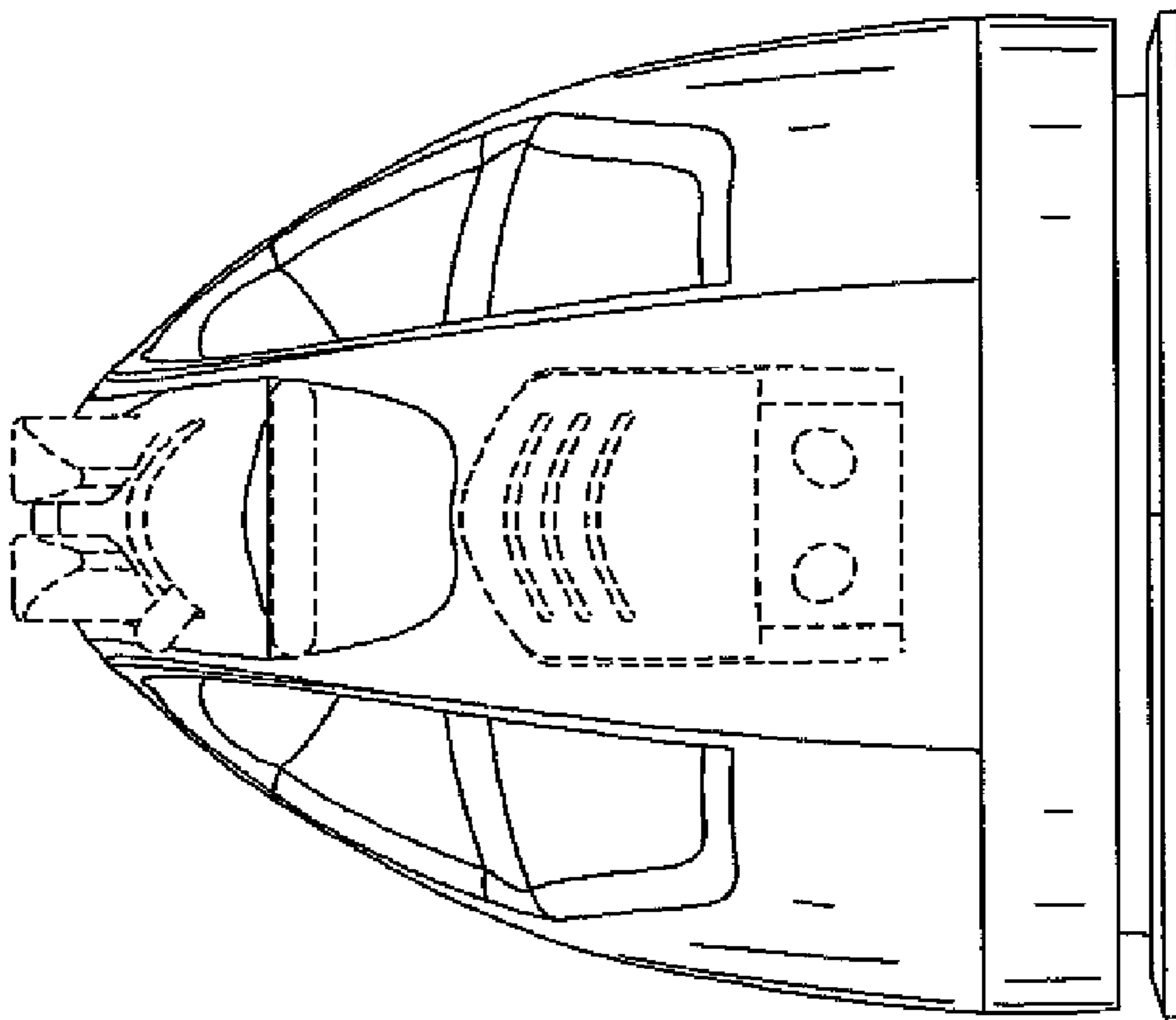

FIG 4

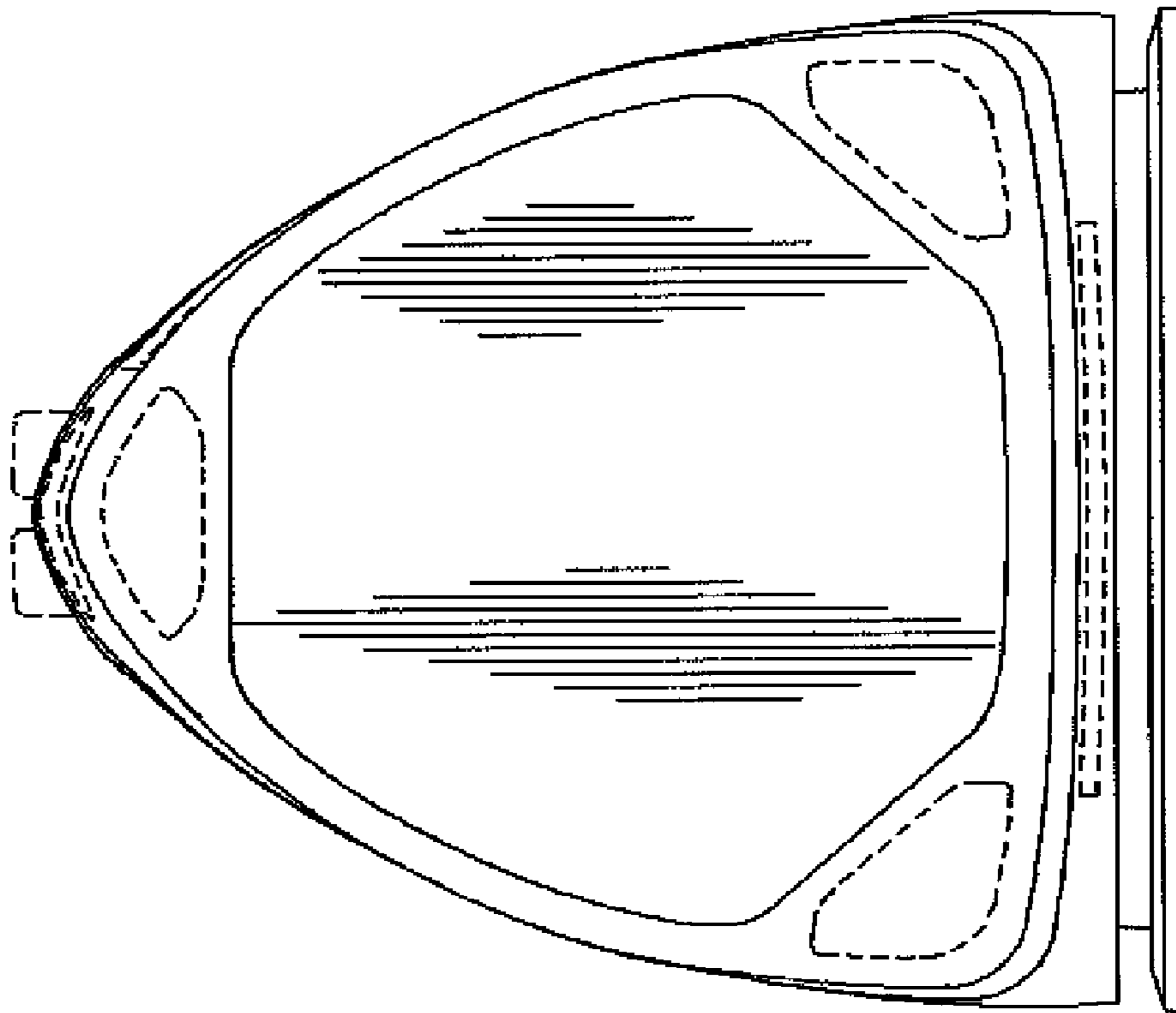

FIG 5

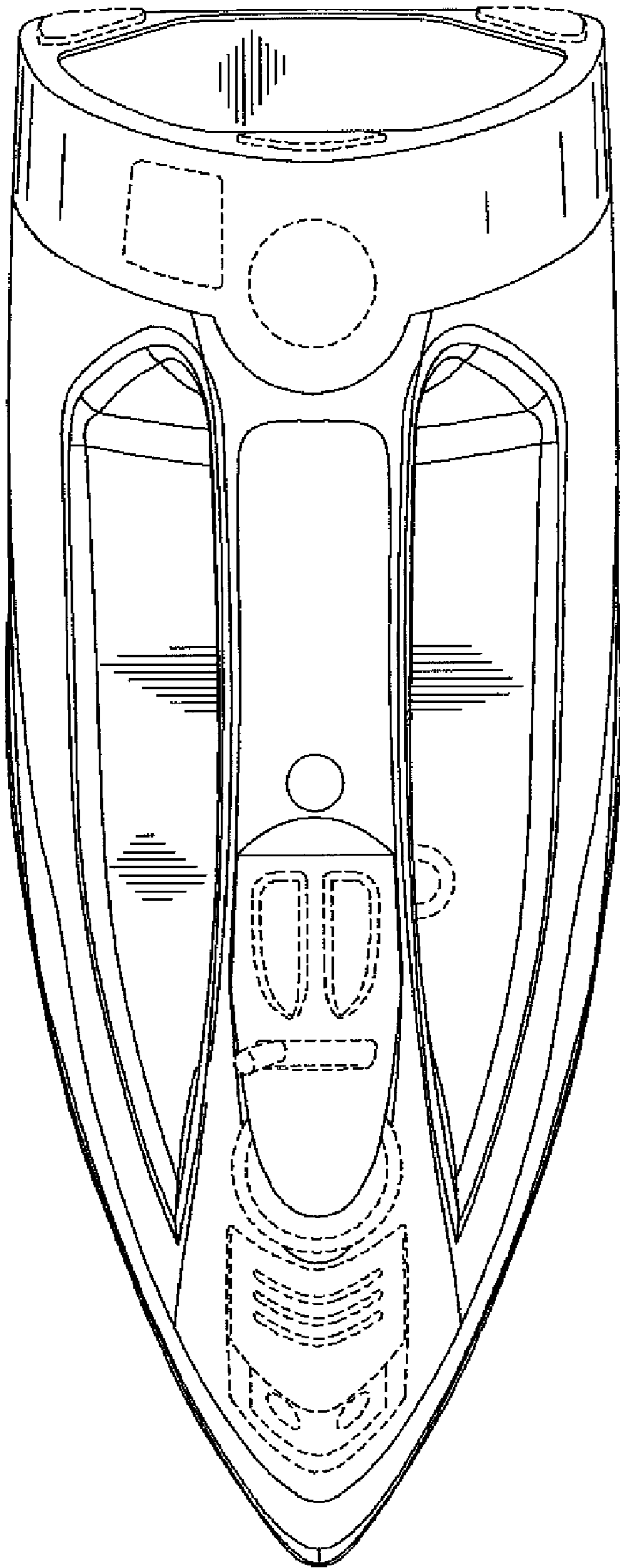

FIG 6

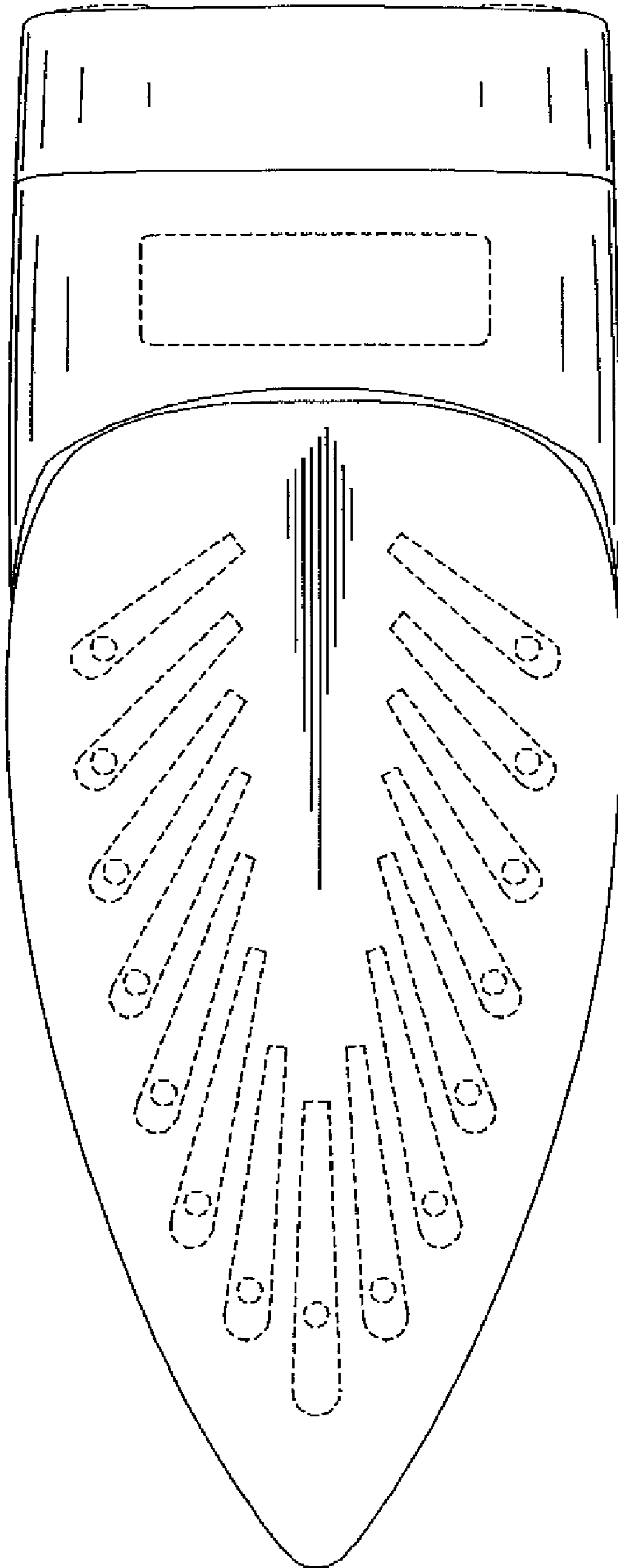

FIG 7