



US00D629970S

(12) **United States Design Patent**
Volpenhein et al.

(10) **Patent No.:** **US D629,970 S**
(45) **Date of Patent:** **** Dec. 28, 2010**

(54) **DENTAL FLOSS PICK**

(75) Inventors: **Daniel William Volpenhein**, Mason, OH (US); **Douglas Craig Hardesty**, Amelia, OH (US); **David Eric Dintenfass**, Cincinnati, OH (US); **Sarah T. Irizarry**, Fort Thomas, KY (US); **Alexander King**, Cincinnati, OH (US)

(73) Assignee: **The Procter & Gamble Company**, Cincinnati, OH (US)

(**) Term: **14 Years**

(21) Appl. No.: **29/361,962**

(22) Filed: **May 18, 2010**

(51) **LOC (9) Cl.** **28-03**

(52) **U.S. Cl.** **D28/68**

(58) **Field of Classification Search** D28/31,
D28/56, 65-68, 73; D24/152; 433/141,
433/146-147; 132/322-329

See application file for complete search history.

(56) **References Cited**

U.S. PATENT DOCUMENTS

1,414,604 A 5/1922 Thum

(Continued)

FOREIGN PATENT DOCUMENTS

DE 4439931 9/1996

(Continued)

OTHER PUBLICATIONS

Floss Accessories from <https://cart.jbutler.com/store.php?cm=223>, Feb. 11, 2009, 13 pages, GUM®.

(Continued)

Primary Examiner—Janice E Seeger

Assistant Examiner—Zenia I Bennett

(74) *Attorney, Agent, or Firm*—James E. Oehlenschlager

(57) **CLAIM**

The ornamental design for a dental floss pick, as shown and described.

DESCRIPTION

FIG. 1 is a perspective view of a dental floss pick, embodying the new design;

FIG. 2 is a right side elevational view of the dental floss pick of FIG. 1;

FIG. 3 is a left side elevational view of the dental floss pick of FIG. 1;

FIG. 4 is a front elevational view of the dental floss pick of FIG. 1;

FIG. 5 is a rear elevational view of the dental floss pick of FIG. 1;

FIG. 6 is a top planar view of the dental floss pick of FIG. 1;

FIG. 7 is a bottom planar view of the dental floss pick of FIG. 1;

FIG. 8 is a perspective view of another alternative embodiment of the present invention;

FIG. 9 is a right side elevational view of the dental floss pick of FIG. 8;

FIG. 10 is a left side elevational view of the dental floss pick of FIG. 8;

FIG. 11 is a front elevational view of the dental floss pick of FIG. 8;

FIG. 12 is a rear elevational view of the dental floss pick of FIG. 8;

FIG. 13 is a top planar view of the dental floss pick of FIG. 8; and,

FIG. 14 is a bottom planar view of the dental floss pick of FIG. 8.

The broken lines shown in the drawings are for illustrative purposes only and form no part of the claimed design. The stippling in FIGS. 1 to 14 represents glitter.

1 Claim, 8 Drawing Sheets

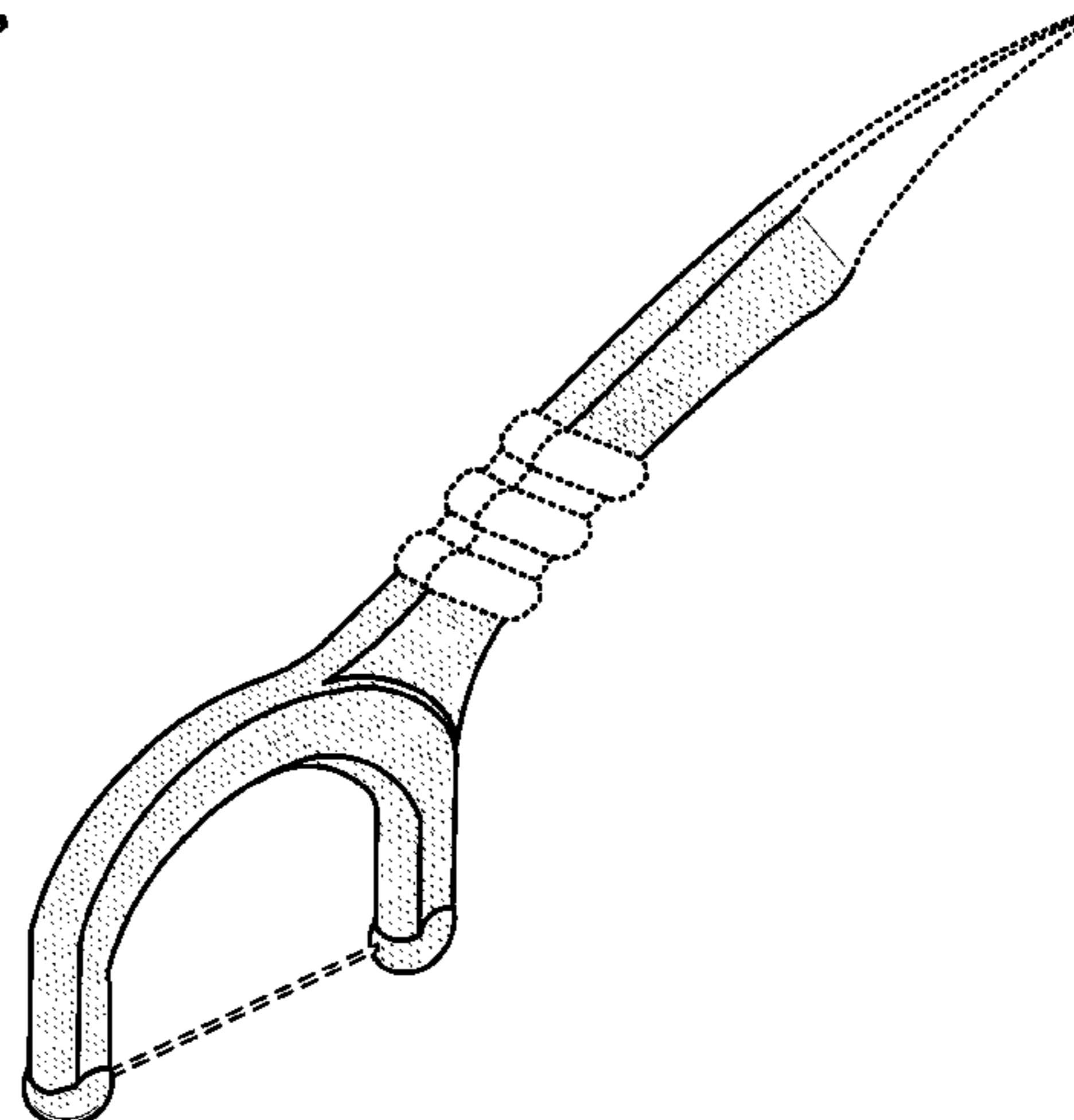
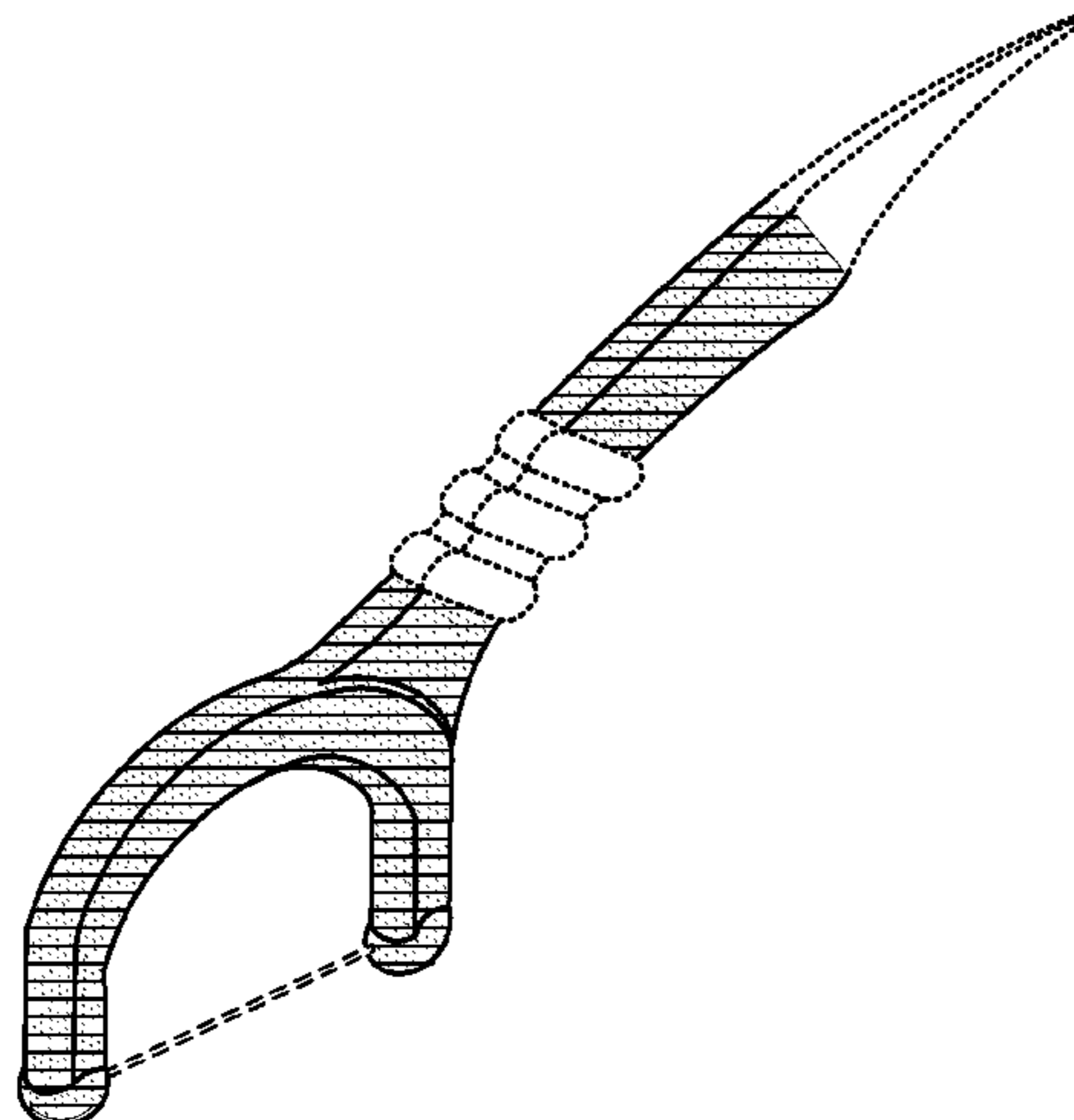

US D629,970 S

Page 2

U.S. PATENT DOCUMENTS

D274,375 S 6/1984 Tomlin et al.
D276,088 S 10/1984 Fong
D279,826 S 7/1985 Schindler
D301,071 S 5/1989 Franchi
D309,041 S 7/1990 Schneider
D309,803 S 8/1990 Potter
D316,617 S 4/1991 Cheung
5,388,600 A 2/1995 Hart
D357,551 S 4/1995 Schindler
5,538,023 A 7/1996 Oczkowski et al.
D374,744 S 10/1996 Dolan et al.
5,692,531 A 12/1997 Chodorow
D398,076 S 9/1998 Hafkin
D401,701 S 11/1998 Chodorow
5,829,458 A 11/1998 Chodorow
D403,120 S 12/1998 Enriquez
D410,115 S 5/1999 Chodorow
D412,043 S 7/1999 Dolan et al.
5,975,296 A 11/1999 Dolan et al.
D424,748 S 5/2000 Dolan et al.
D481,829 S 11/2003 Gwen
D484,643 S 12/2003 Nanda
D489,490 S 5/2004 Chodorow
D497,222 S 10/2004 Ochs et al.
D503,496 S 3/2005 Nanda

6,973,933 B2* 12/2005 Gwen 132/323
D523,934 S 6/2006 Schaffeld et al.
D525,392 S 7/2006 Crossman
D531,756 S 11/2006 Yost et al.
D531,758 S 11/2006 Jansheski et al.
D532,160 S 11/2006 Jansheski et al.
D532,934 S 11/2006 Crossman
D533,965 S* 12/2006 Chodorow et al. D28/68
D545,499 S 6/2007 Xu
7,370,658 B2 5/2008 Chodorow et al.
2007/0017546 A1 1/2007 Brown
2007/0157946 A1 7/2007 Lui et al.
2008/0185016 A1 8/2008 Jansheski et al.

FOREIGN PATENT DOCUMENTS

GB 2003250 5/1990
WO WO 00/36993 6/2000
WO WO 01/12100 2/2001

OTHER PUBLICATIONS

Floss Accessories from <http://ranir.com/travel-12.html>, Feb. 11, 2009, 10 pages, © Johnson and Johnson Corporation.
Plackers® Dental Products From Placontrol from <http://www.dentist.net/plackers.asp>, Feb. 11, 2009, 8 pages.

* cited by examiner

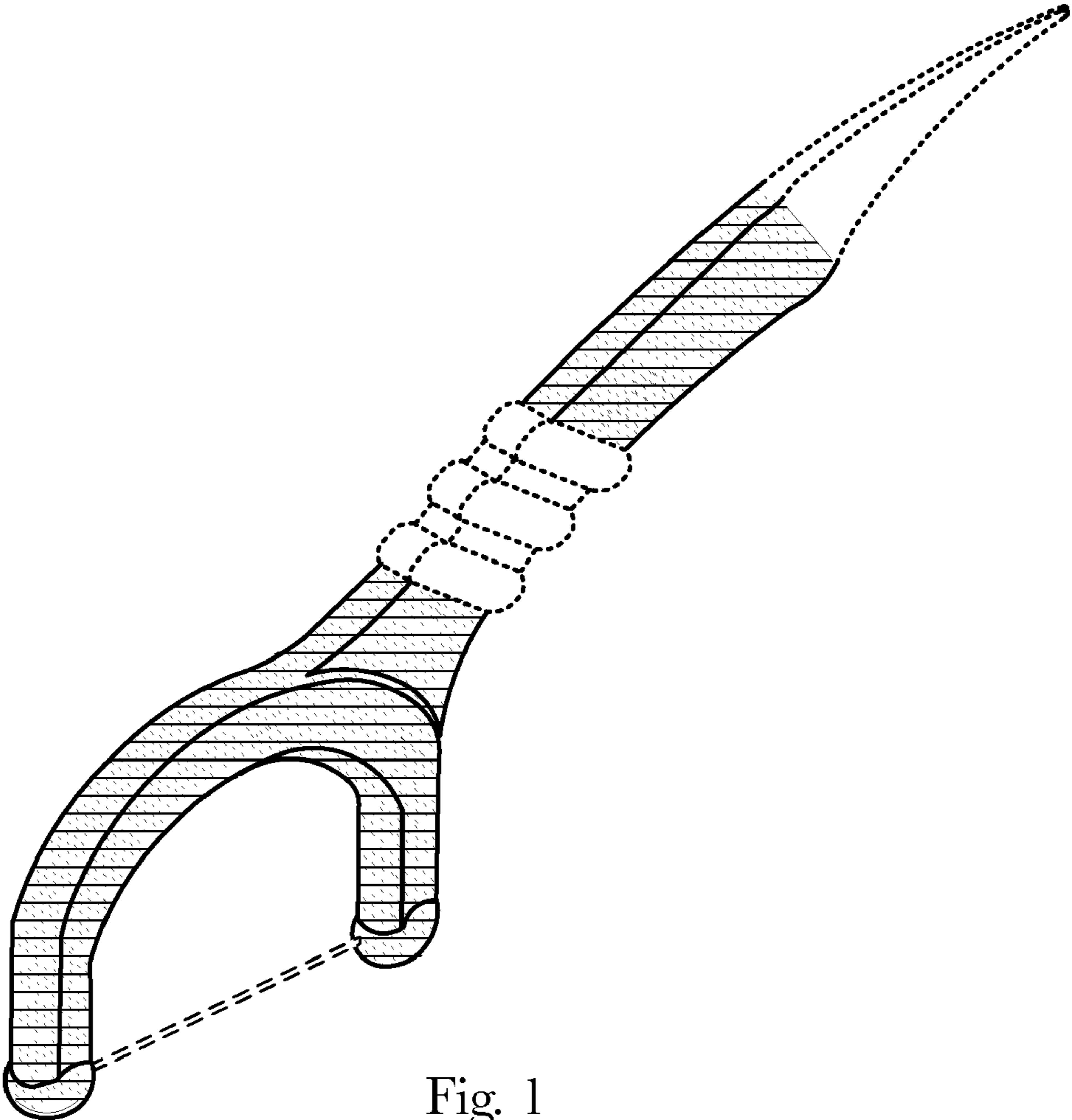

Fig. 1

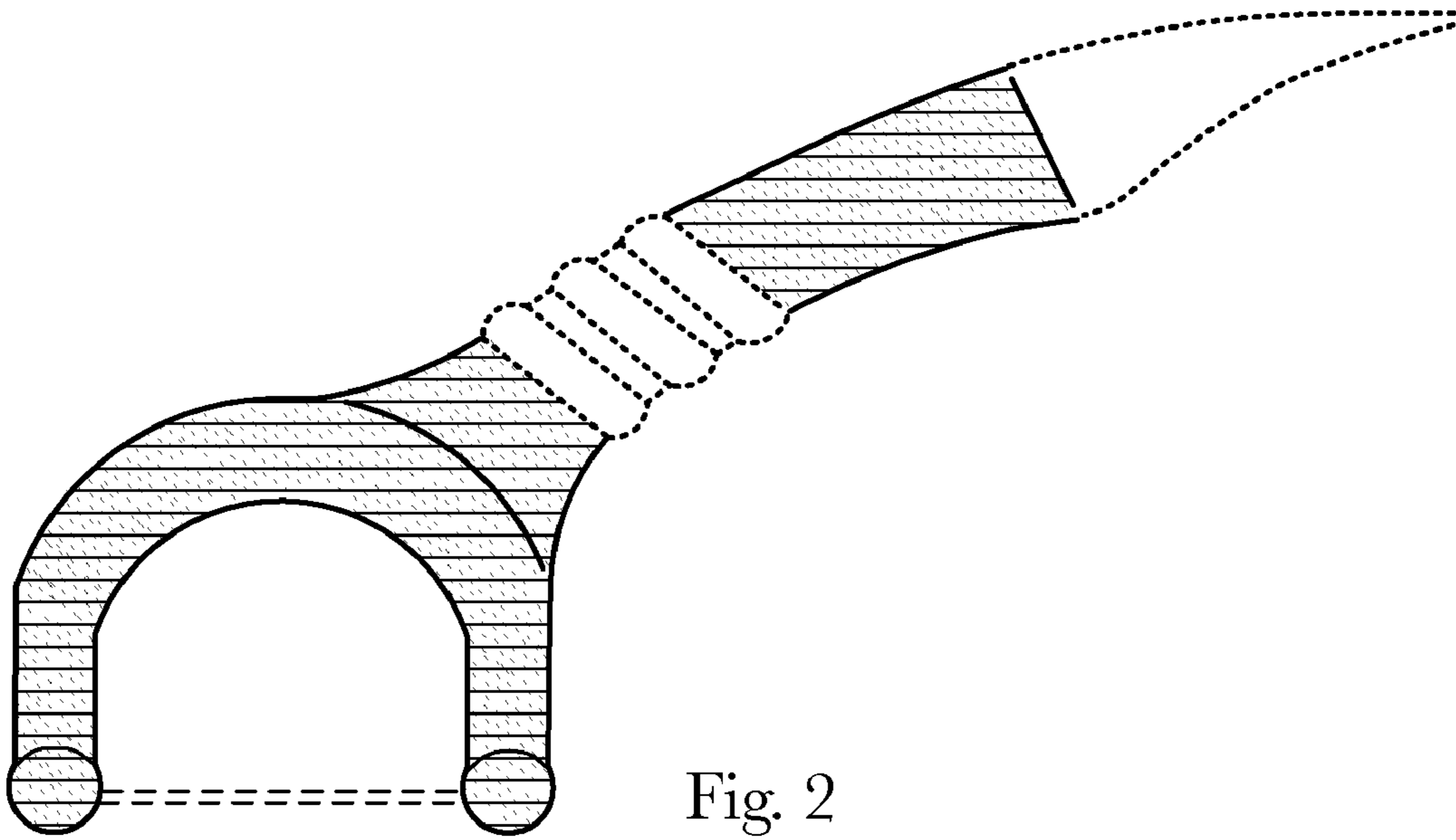

Fig. 2

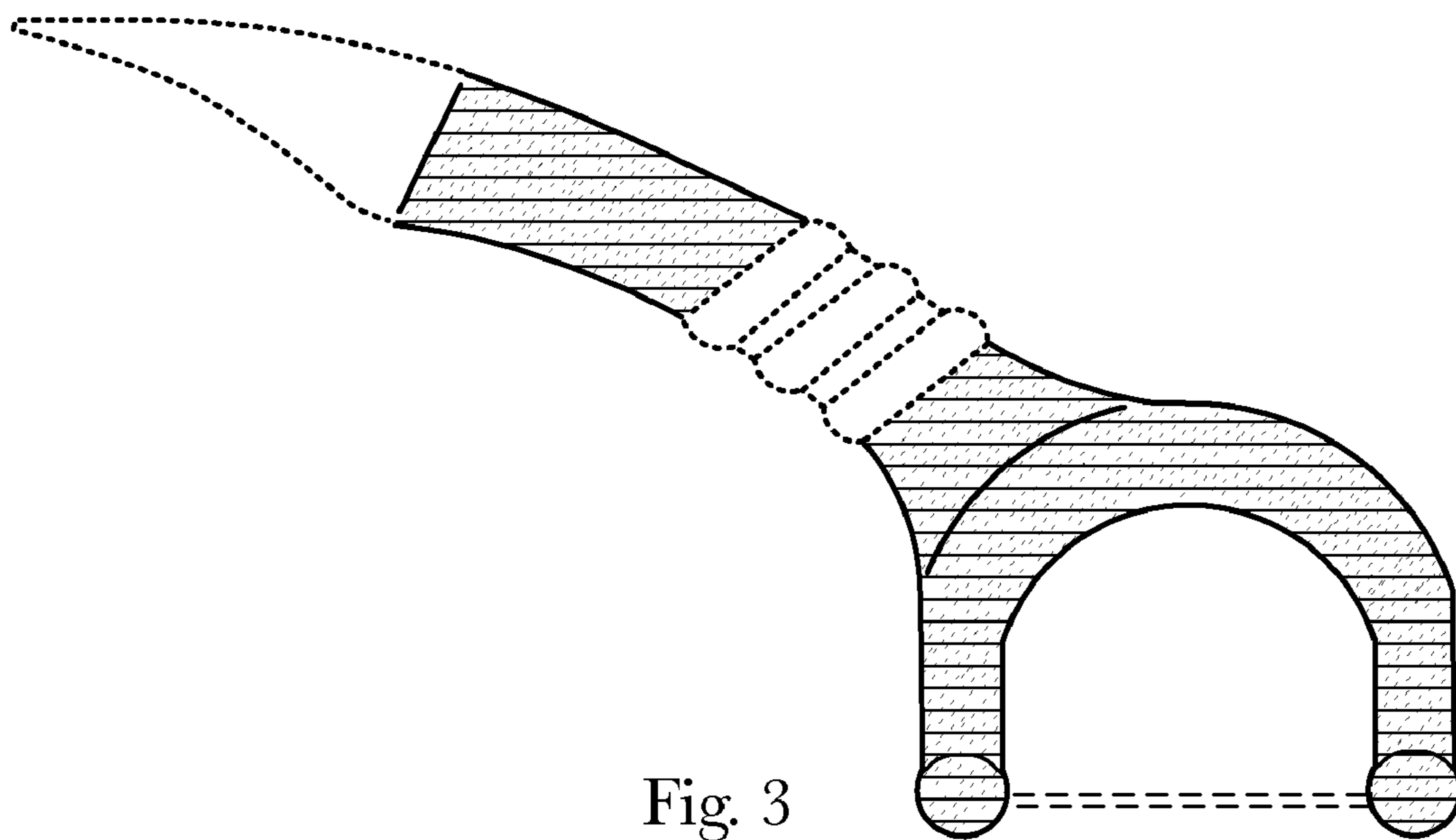

Fig. 3

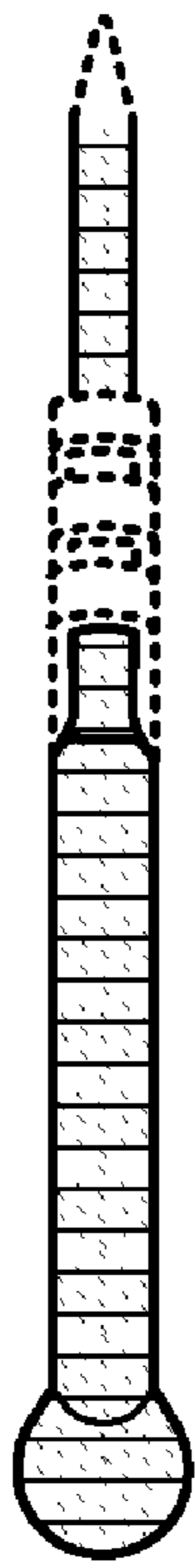

Fig. 4

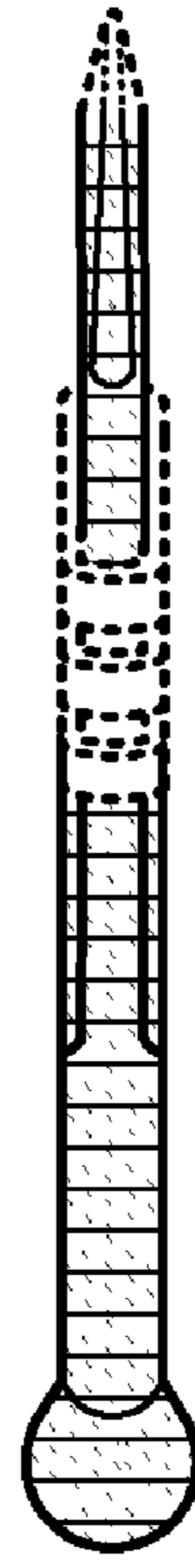

Fig. 5

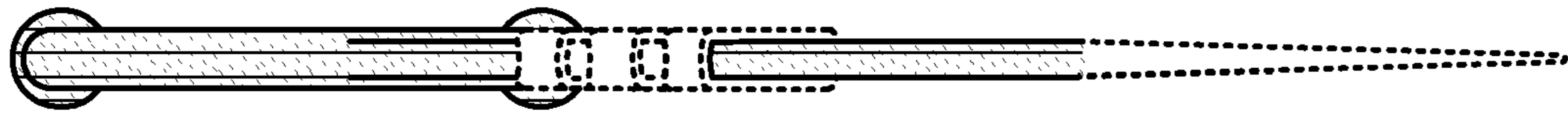

Fig. 6



Fig. 7

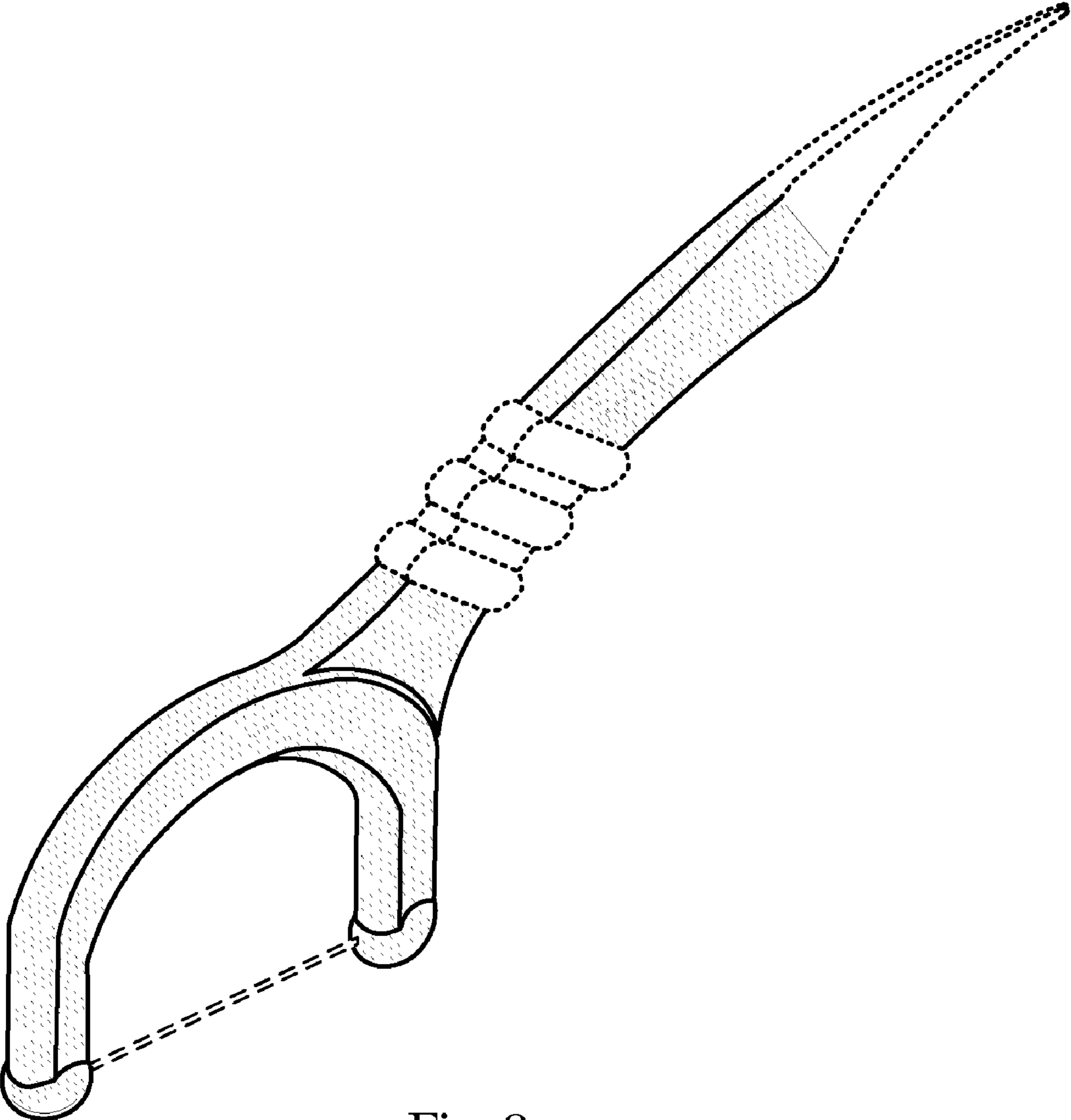

Fig. 8

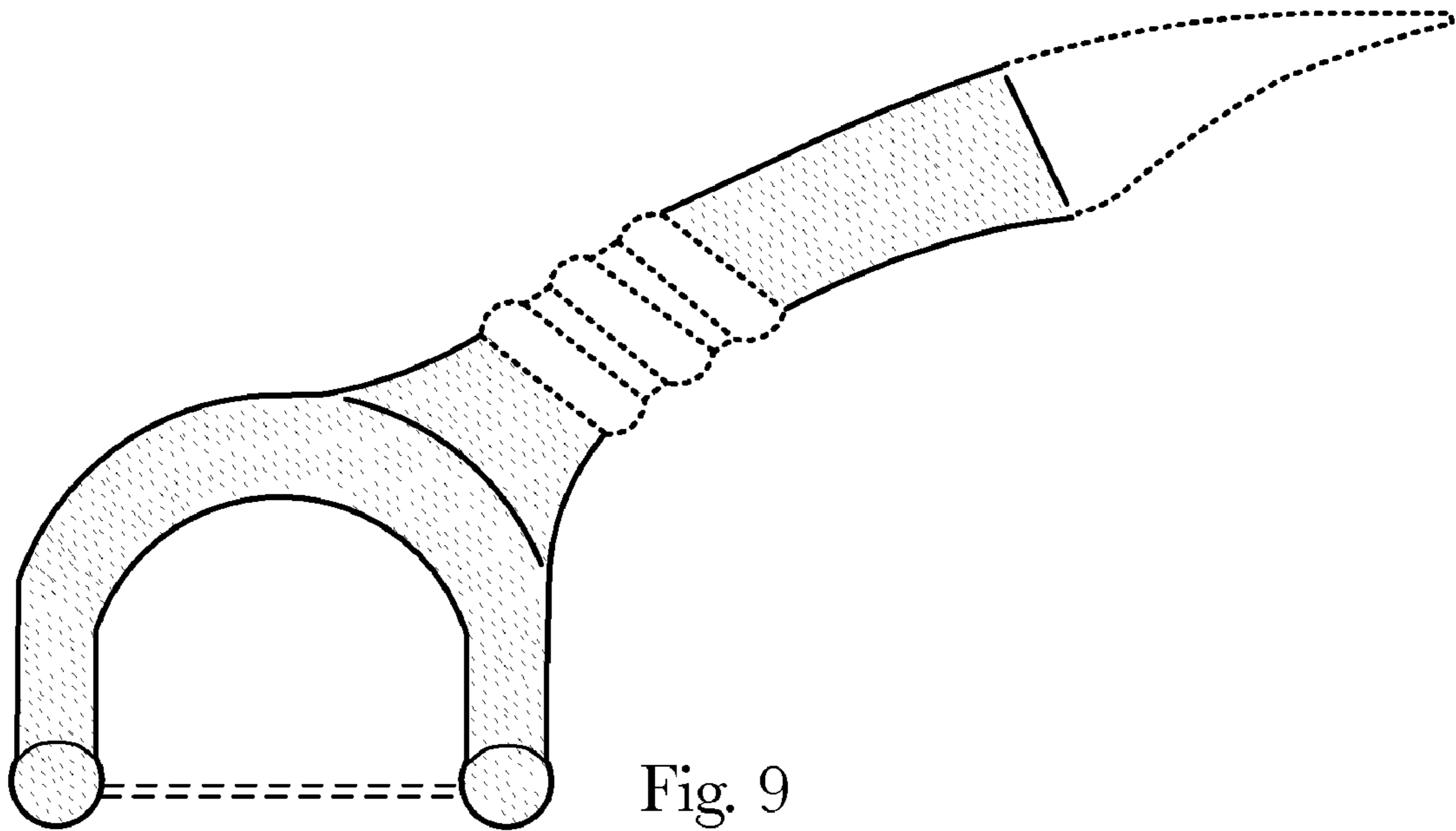

Fig. 9

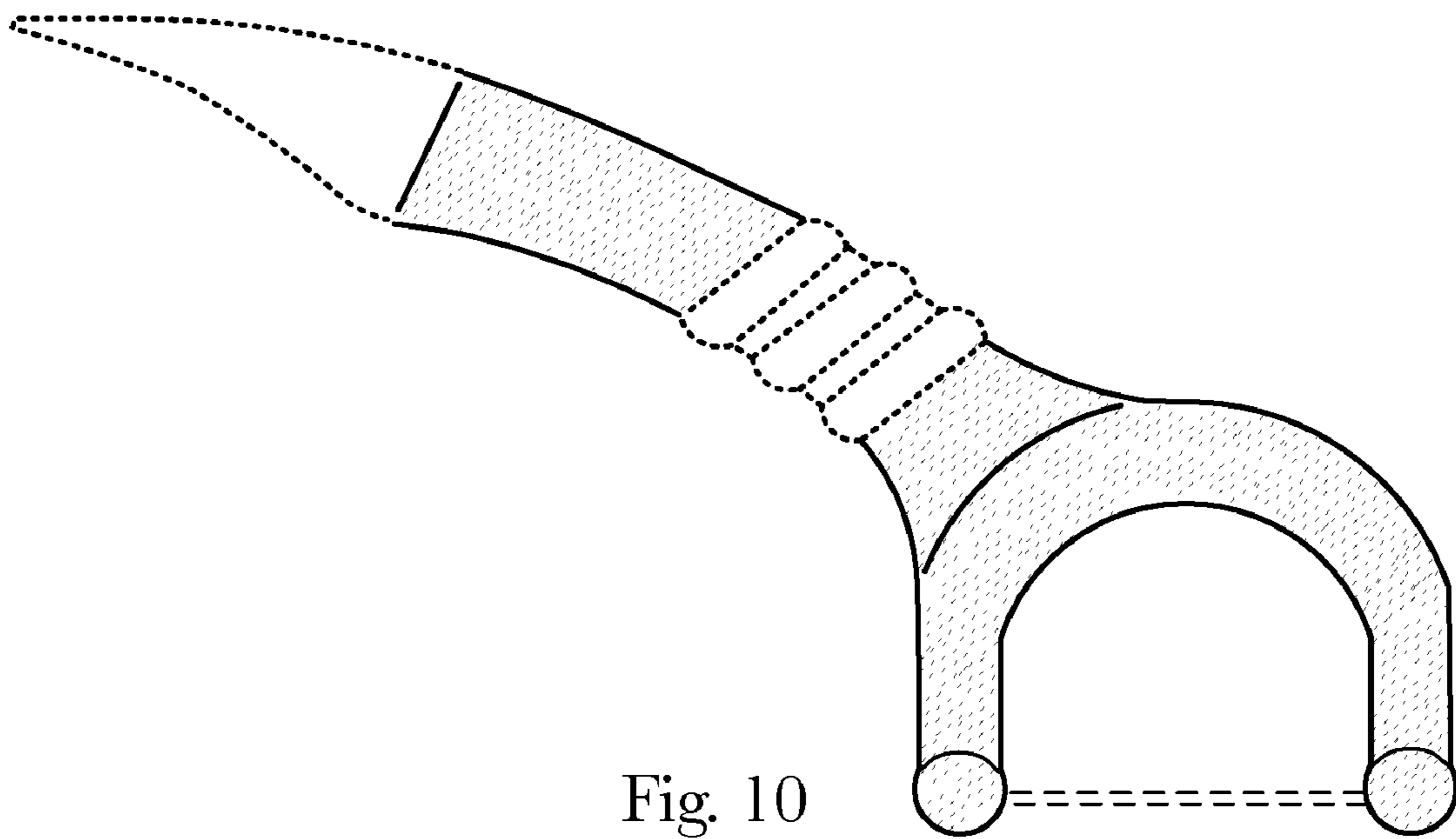

Fig. 10

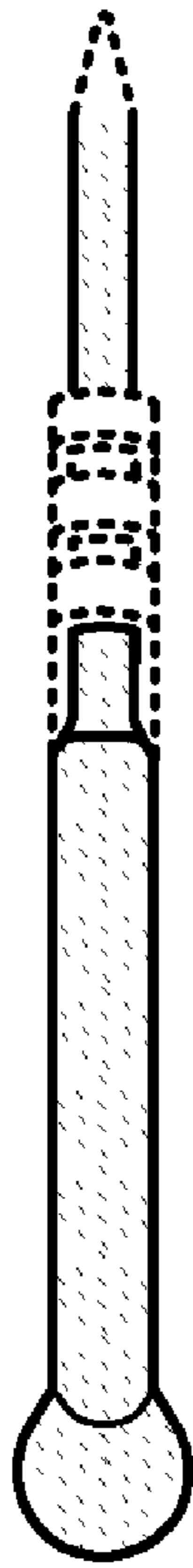

Fig. 11

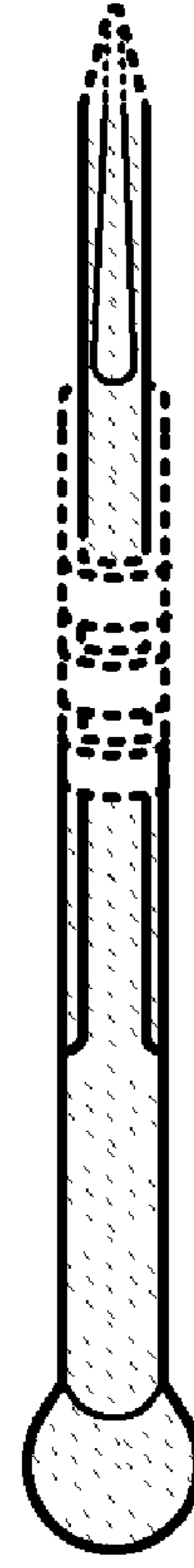

Fig. 12

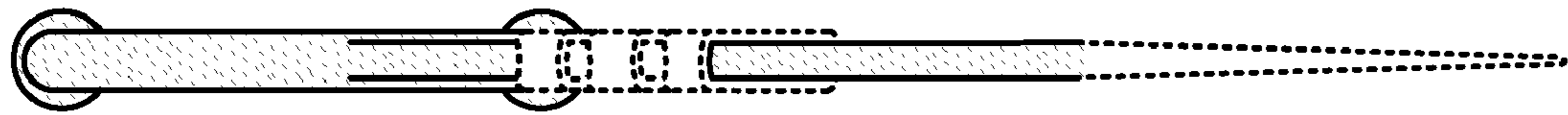

Fig. 13



Fig. 14