



US00D629705S

(12) **United States Design Patent**  
**Furetta**

(10) **Patent No.:** **US D629,705 S**

(45) **Date of Patent:** **\*\* Dec. 28, 2010**

(54) **WRIST WATCH**

(75) Inventor: **Alessandra Furetta**, Evillard (CH)

(73) Assignee: **Rado Uhren AG (Rado Watch Co. Ltd.) (Montres Rado SA)**, Lengnau (CH)

(\*\*) Term: **14 Years**

(21) Appl. No.: **29/365,055**

(22) Filed: **Jul. 2, 2010**

(30) **Foreign Application Priority Data**

Jan. 22, 2010 (WO) ..... DM/072 950

(51) **LOC (9) Cl.** ..... **10-02**

(52) **U.S. Cl.** ..... **D10/32**

(58) **Field of Classification Search** ..... D10/30-39,  
D10/122-132; 368/276, 281, 282, 285, 80,  
368/223, 228, 232; D11/3, 12

See application file for complete search history.

(56) **References Cited**

**U.S. PATENT DOCUMENTS**

- 2,461,693 A \* 2/1949 McAloon ..... 24/265 B
- 3,359,718 A \* 12/1967 Nydegger ..... 368/37
- D215,112 S \* 9/1969 Meylan ..... D10/38
- 3,735,585 A \* 5/1973 Takagi ..... 368/281
- 3,748,849 A \* 7/1973 Takagi ..... 368/292
- D320,358 S \* 10/1991 Bulgari ..... D10/32
- D320,946 S \* 10/1991 Crocco ..... D10/32
- D331,884 S \* 12/1992 Wunderman ..... D10/32
- D336,440 S \* 6/1993 Favre ..... D10/32
- D405,016 S \* 2/1999 Bach ..... D10/32
- D405,375 S \* 2/1999 Chodat ..... D10/39
- D411,806 S \* 7/1999 Rousseau ..... D10/32
- D420,920 S \* 2/2000 Bach ..... D10/32
- D436,046 S \* 1/2001 Giardiello ..... D10/32

- D436,047 S \* 1/2001 Giardiello ..... D10/32
- 6,200,019 B1 \* 3/2001 Latini ..... 368/289
- D447,700 S \* 9/2001 Glauser ..... D10/32
- D451,820 S \* 12/2001 Sugisawa ..... D10/30
- D453,299 S \* 2/2002 Bach et al. .... D10/39
- D465,422 S \* 11/2002 Mantovani ..... D10/30
- D466,031 S \* 11/2002 Mantovani ..... D10/30
- D471,126 S \* 3/2003 Calvani ..... D11/3
- D471,482 S \* 3/2003 Calvani ..... D11/3
- D487,229 S \* 3/2004 Monachon ..... D10/32
- D493,729 S \* 8/2004 Monachon ..... D10/32
- D525,537 S \* 7/2006 Monachon ..... D10/32
- D533,088 S \* 12/2006 Bedat ..... D10/39
- D538,182 S \* 3/2007 Lalo ..... D10/32
- D555,518 S \* 11/2007 Borraccino et al. .... D10/39
- D577,297 S \* 9/2008 Lalo ..... D10/32
- D584,644 S \* 1/2009 De Givenchy ..... D10/39
- D596,049 S \* 7/2009 Jorst et al. .... D10/32
- D598,789 S \* 8/2009 Jorst et al. .... D10/38

\* cited by examiner

*Primary Examiner*—Lucy Lieberman

(74) *Attorney, Agent, or Firm*—Collen IP; Donald J. Ranft

(57) **CLAIM**

The ornamental design for a wrist watch, as shown and described.

**DESCRIPTION**

FIG. 1 is a front view of my new, original and ornamental design for a wrist watch;

FIG. 2 is a rear view thereof;

FIG. 3 is a bottom view thereof;

FIG. 4 is a top view thereof;

FIG. 5 is a right side view thereof;

FIG. 6 is a left side view thereof; and,

FIG. 7 is a front perspective view thereof.

**1 Claim, 4 Drawing Sheets**

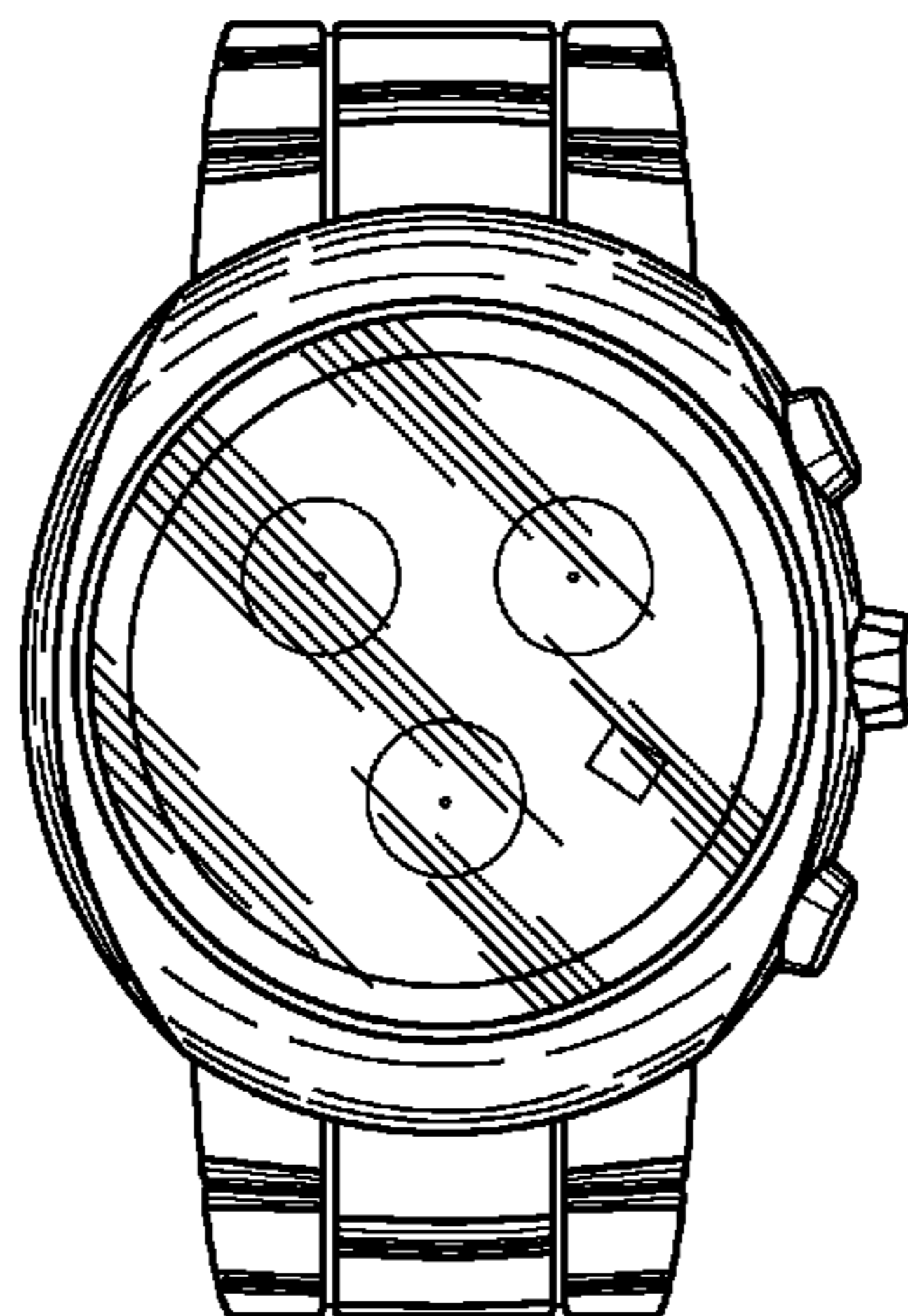

Fig. 1

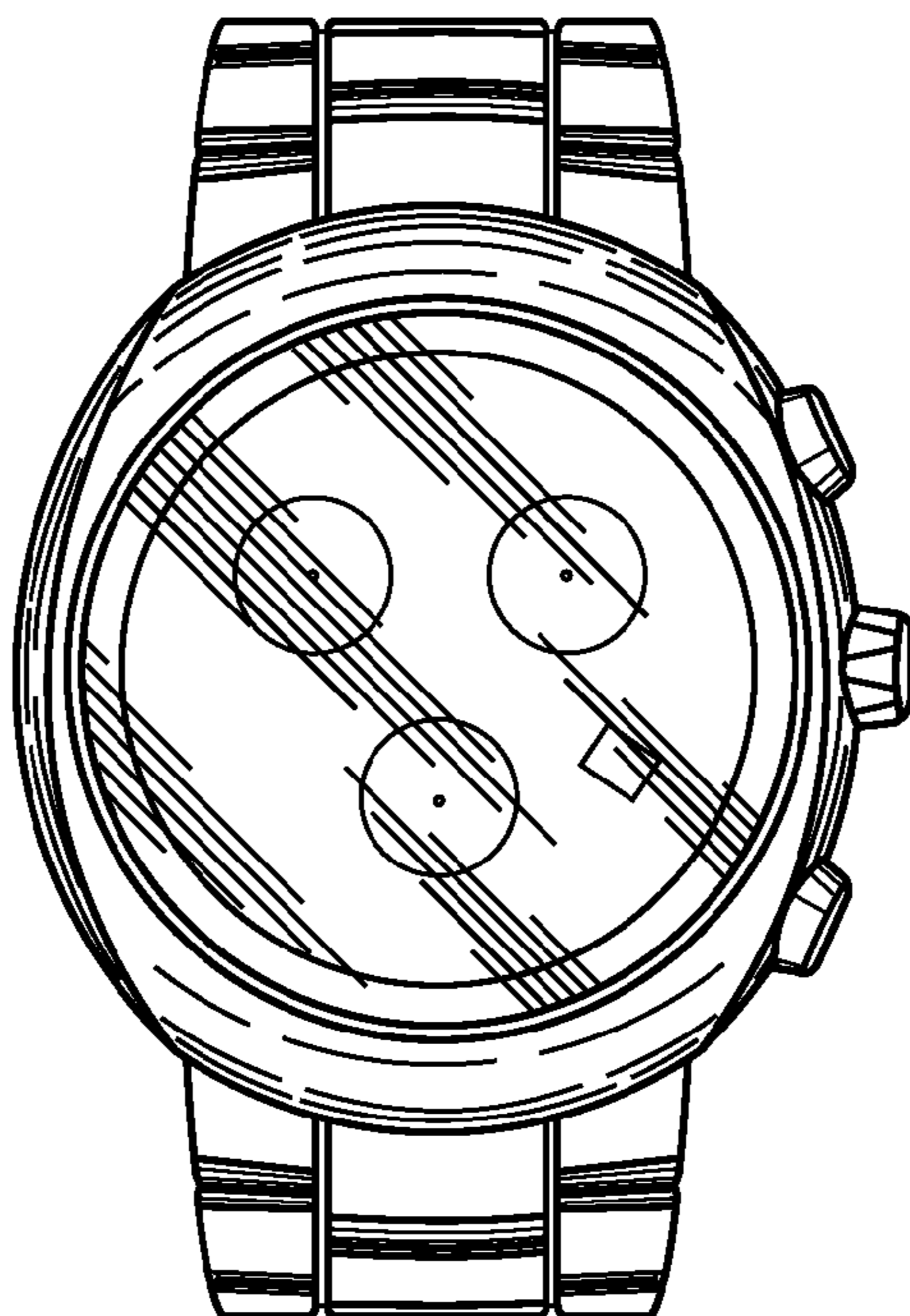

Fig. 2

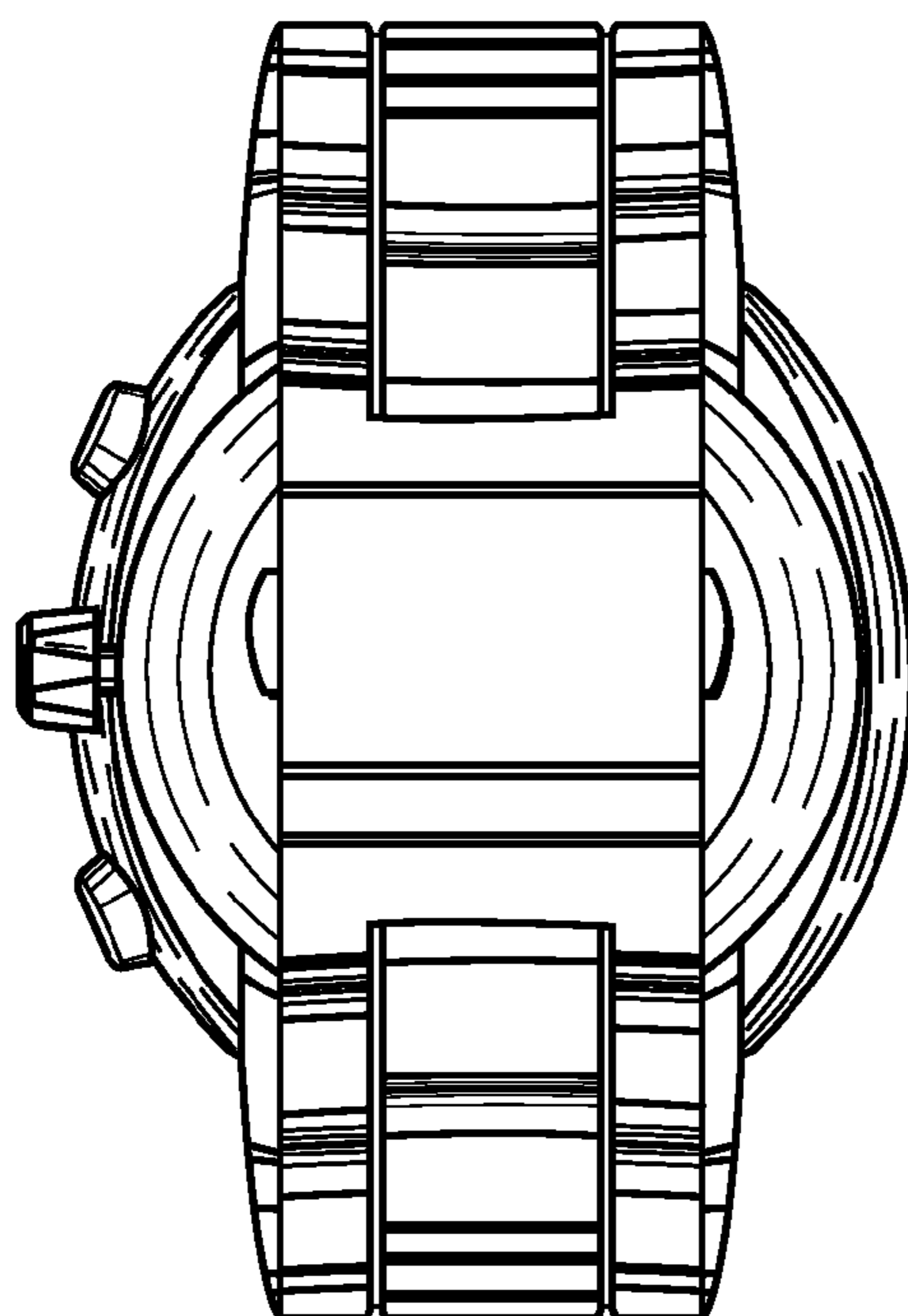

Fig. 3

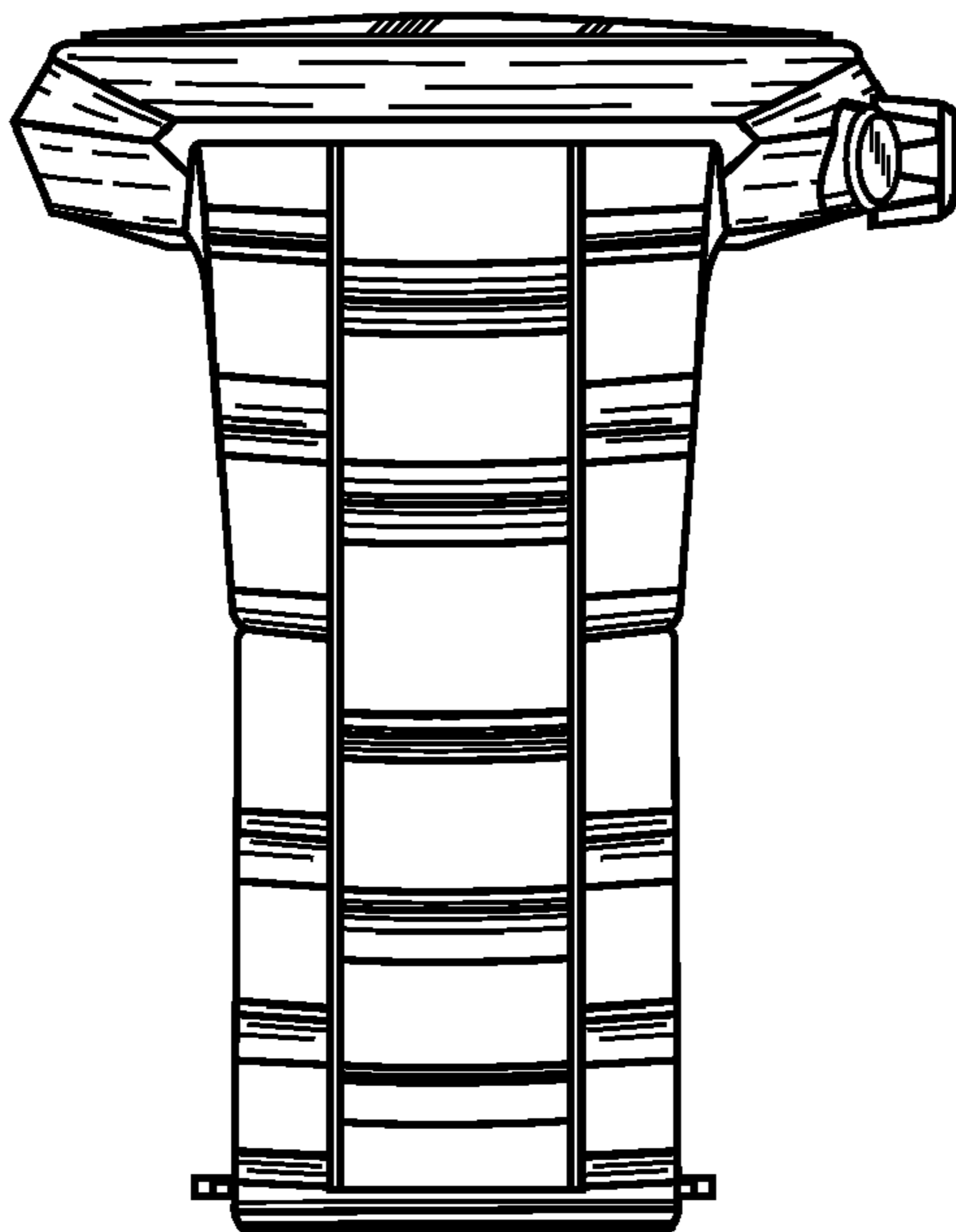

Fig. 4

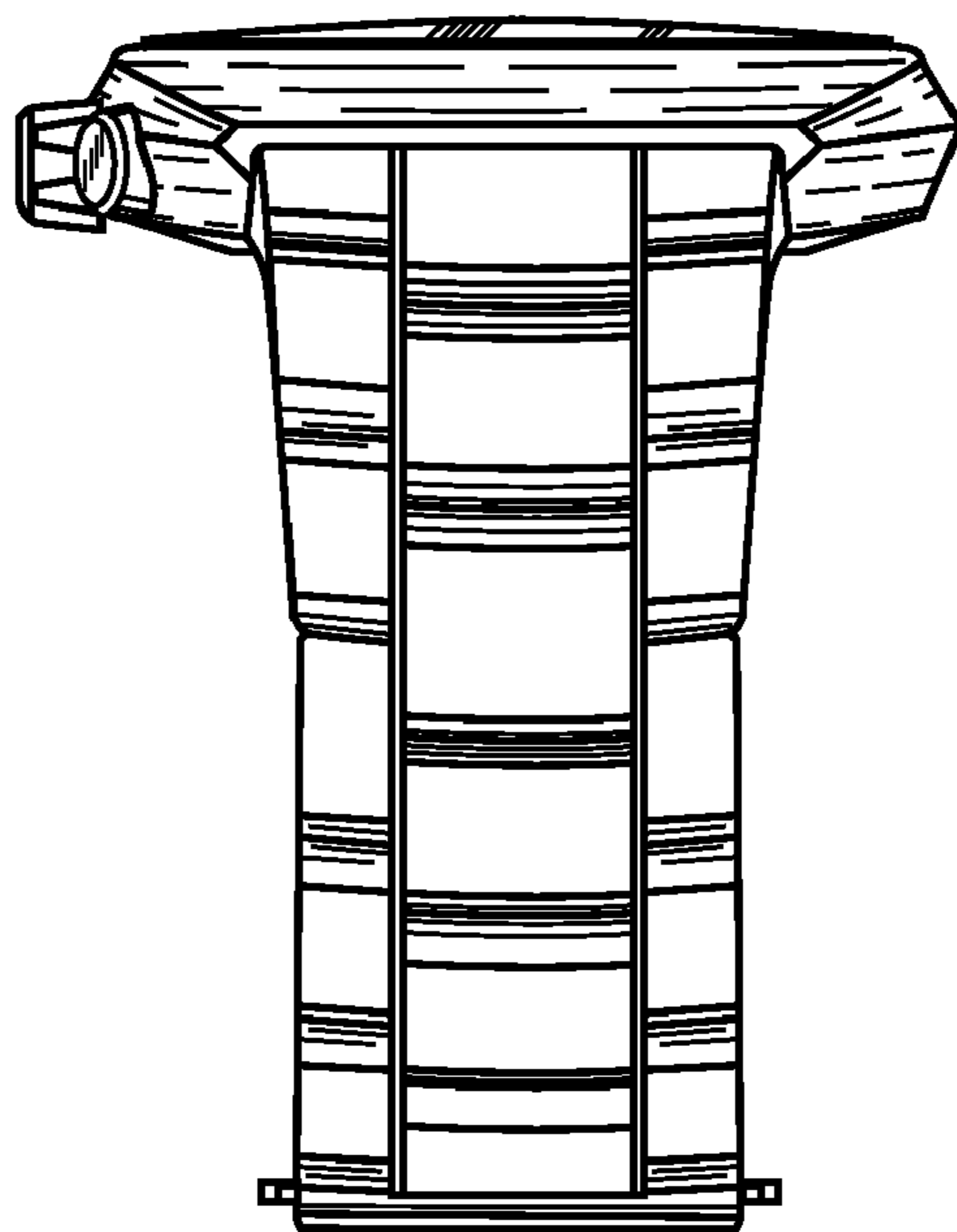

Fig. 5

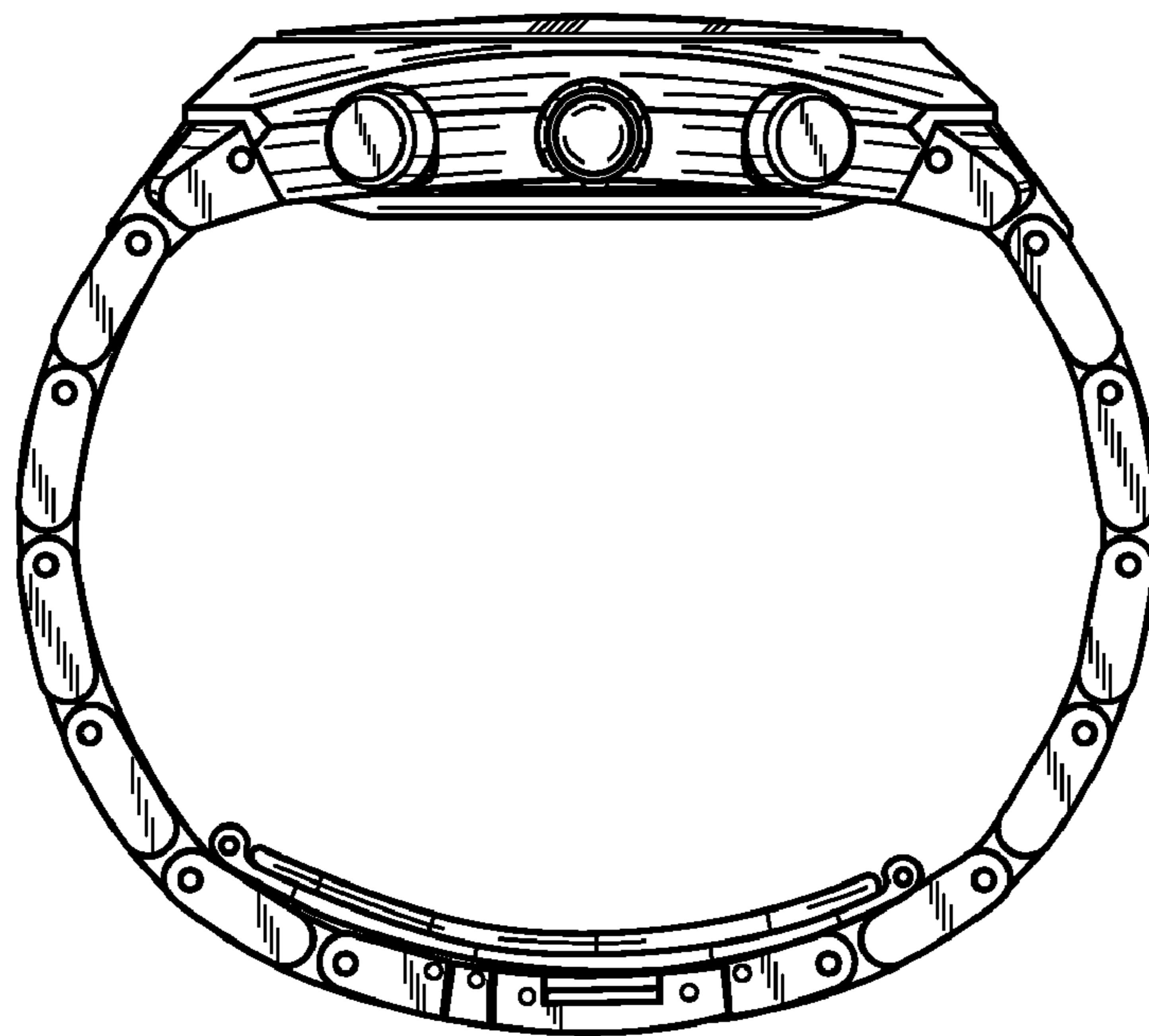

Fig. 6

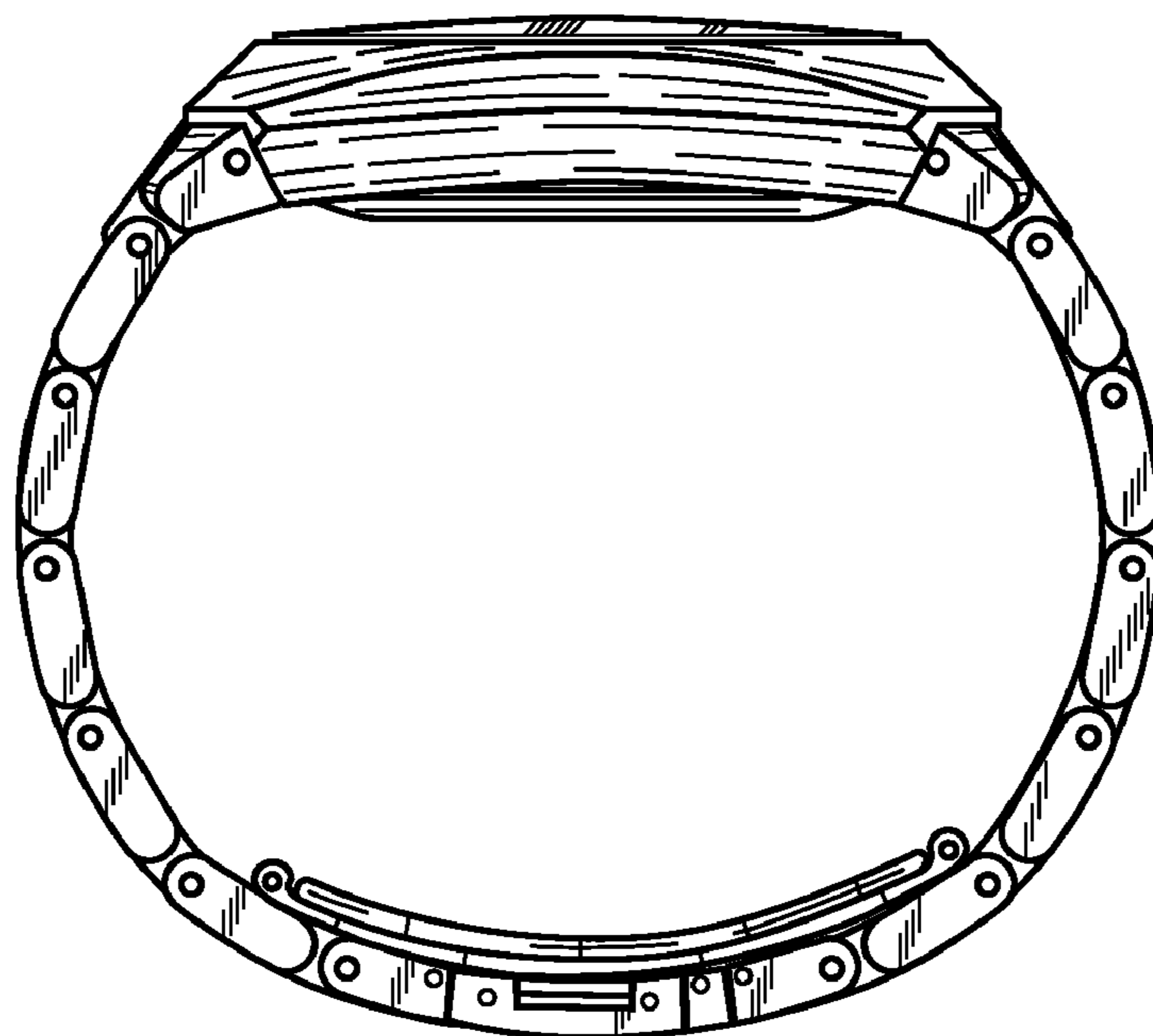

Fig. 7

