



US00D629692S

(12) **United States Design Patent**  
**Lauret**

(10) **Patent No.:** **US D629,692 S**  
(45) **Date of Patent:** **\*\* Dec. 28, 2010**

(54) **BOTTLE**

(75) Inventor: **Richard Lauret**, Vienne-en-Arthies (FR)

(73) Assignee: **Saverglass, Inc.**, Ramsey, NJ (US)

(\*\*) Term: **14 Years**

(21) Appl. No.: **29/345,661**

(22) Filed: **Oct. 20, 2009**

(51) **LOC (9) Cl.** ..... **09-01**

(52) **U.S. Cl.** ..... **D9/500**

(58) **Field of Classification Search** ..... D9/500,  
D9/502-505, 516, 537-540, 545-546, 549-550,  
D9/557-558, 574-575, 682, 686, 688-692,  
D9/763-764, 772-773, 776-777, 905; D7/300,  
D7/300.1, 589, 591, 598, 601, 605, 608;  
215/379, 381-384; 220/660, 662, 669-673,  
220/675

See application file for complete search history.

(56) **References Cited**

**U.S. PATENT DOCUMENTS**

D362,187 S *	9/1995	Thompson	.....	D9/500
D386,090 S *	11/1997	de Giovellina	.....	D9/544
D424,444 S *	5/2000	Lefebvre	.....	D9/503
D561,589 S *	2/2008	Lewis	.....	D9/500
D592,519 S *	5/2009	Rica	.....	D9/546
D601,424 S *	10/2009	Rica	.....	D9/500

\* cited by examiner

*Primary Examiner*—Charles A Rademaker

*Assistant Examiner*—Dana L Sipos

(57) **CLAIM**

The ornamental design for a bottle, as shown and described.

**DESCRIPTION**

FIG. 1 is a perspective front view of a bottle showing my new design;

FIG. 2 is a front view thereof;

FIG. 3 is a rear view thereof;

FIG. 4 is a right side view thereof;

FIG. 5 is a left side view thereof;

FIG. 6 is a top view thereof;

FIG. 7 is a bottom view thereof;

FIG. 8 is a perspective front view of the bottle of FIGS. 1-7 shown without surface shading and disclaimed subject matter;

FIG. 9 is a front view thereof;

FIG. 10 is a rear view thereof;

FIG. 11 is a left side view thereof;

FIG. 12 is a right side view thereof;

FIG. 13 is a top view thereof; and,

FIG. 14 is a bottom view thereof.

The broken line showing of the remainder of the bottle in FIGS. 1-7 is for environmental purposes only and forms no part of the claimed design.

**1 Claim, 8 Drawing Sheets**

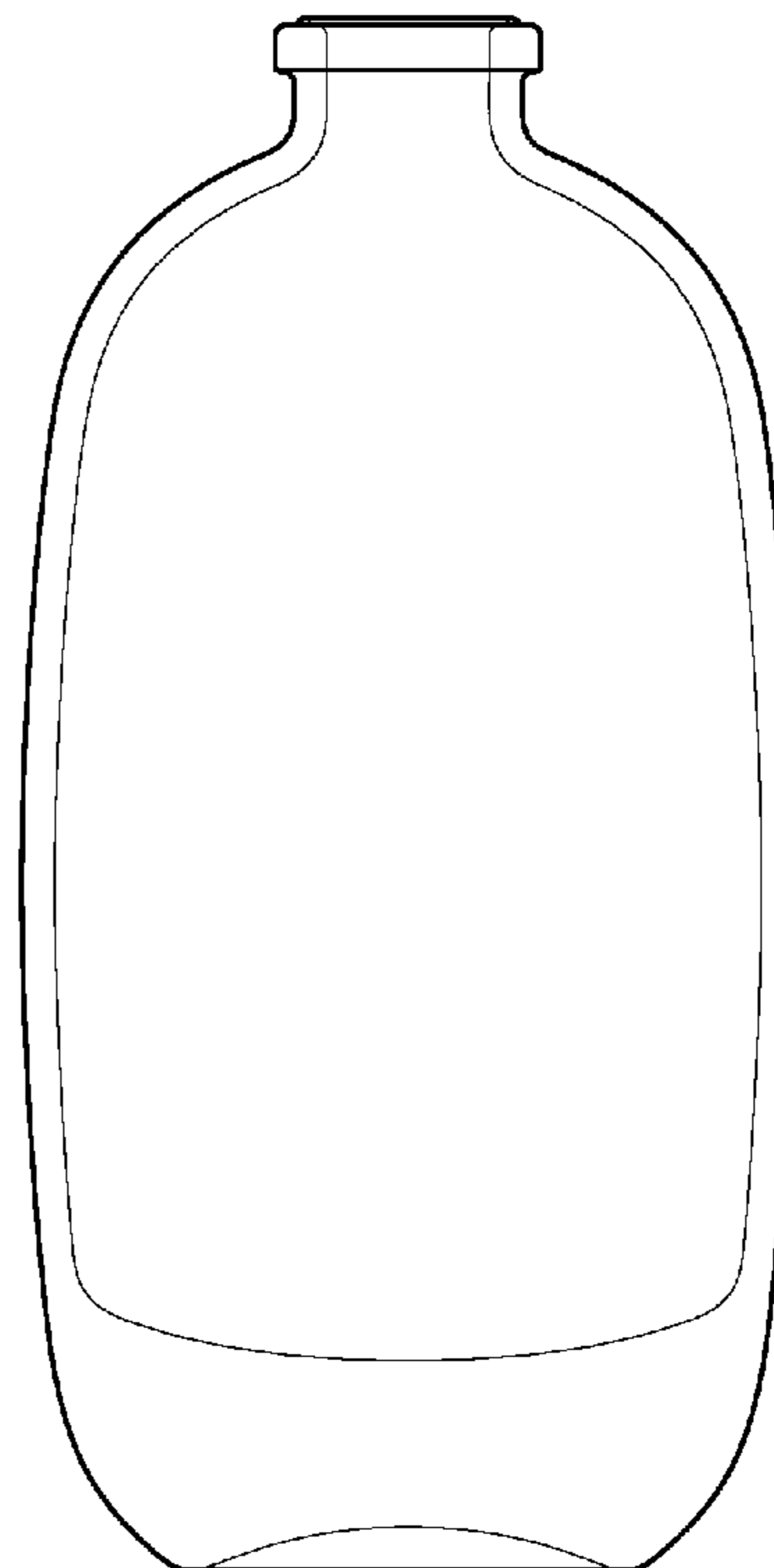
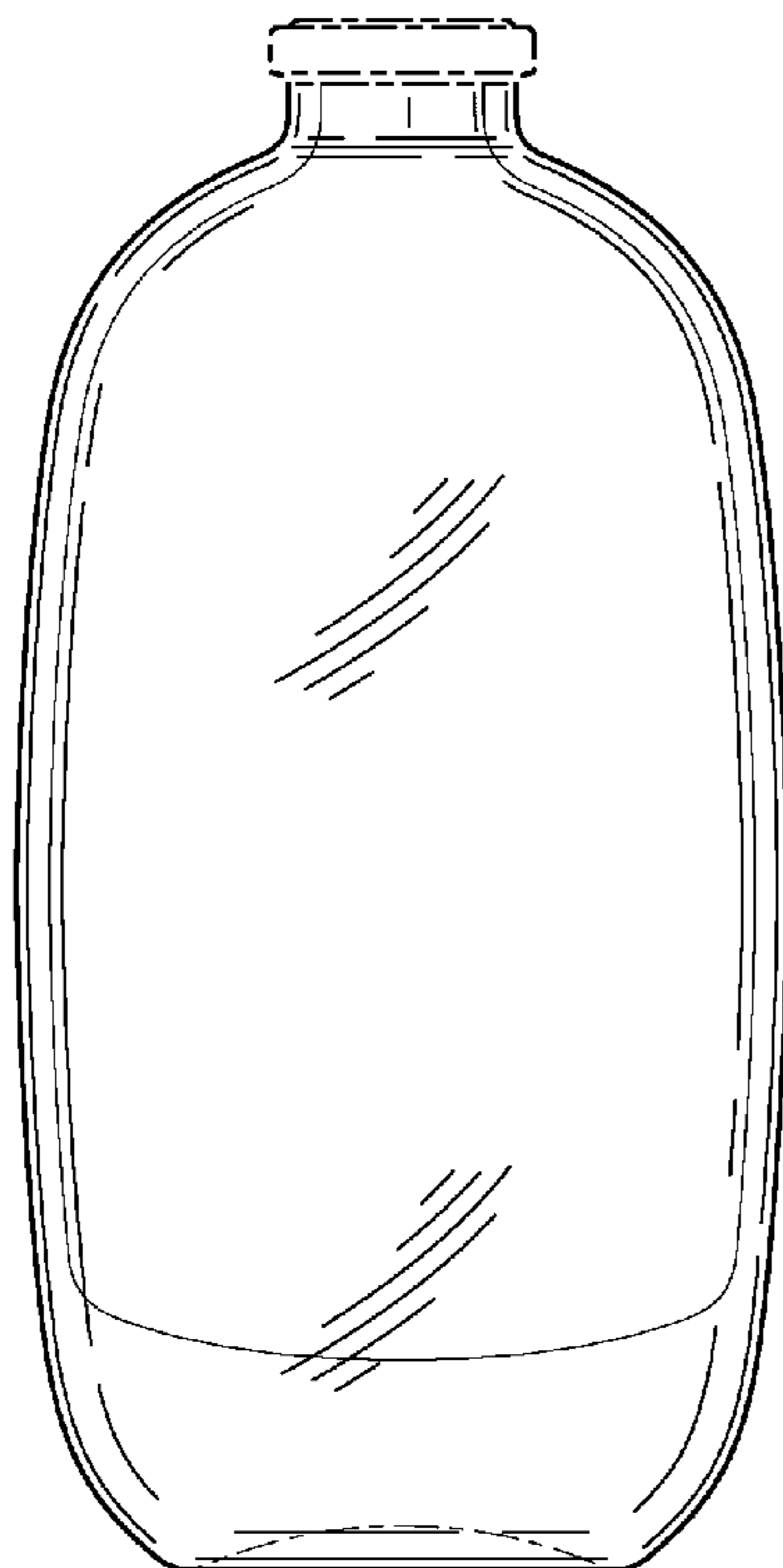

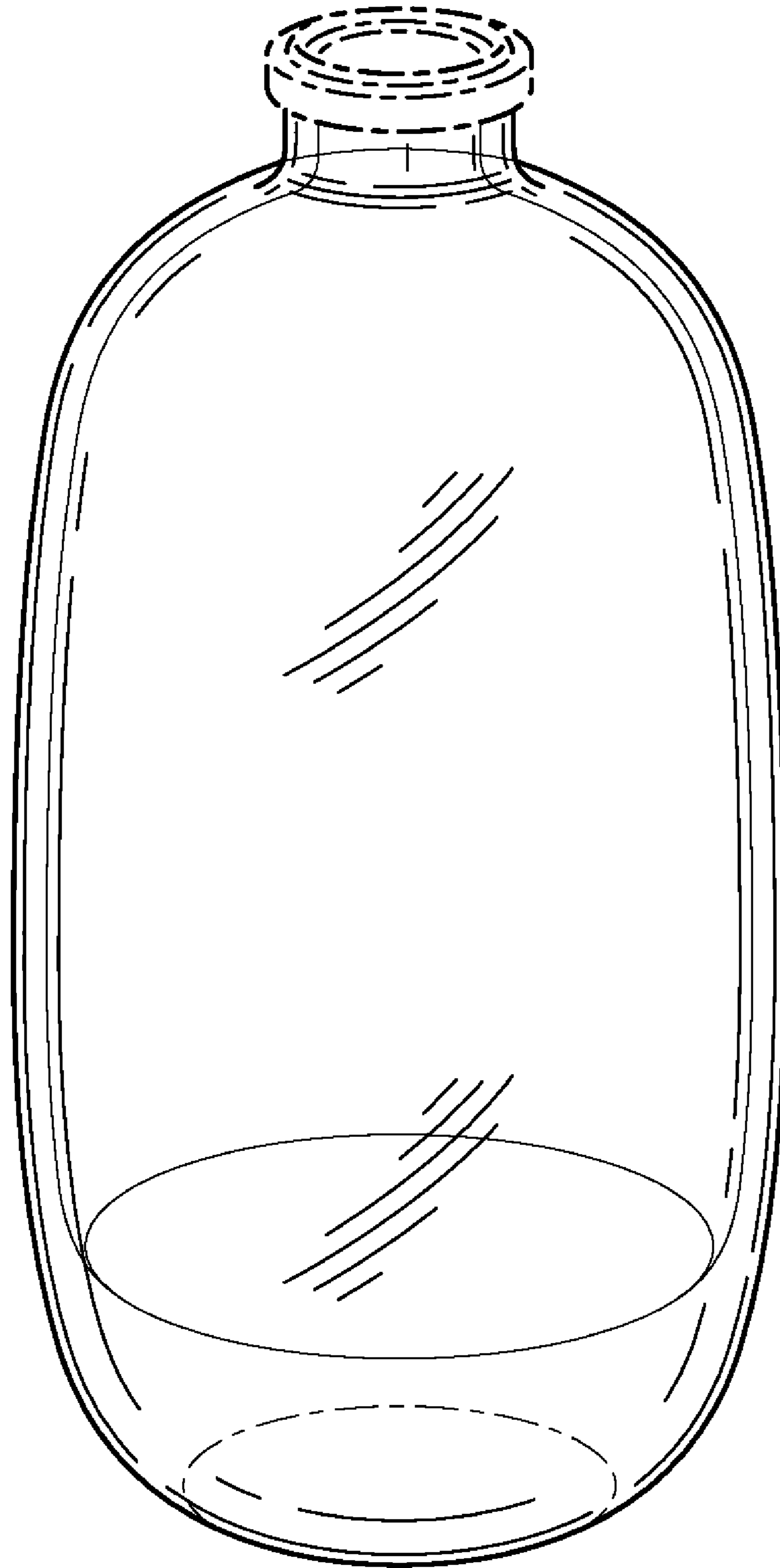

FIG. 1

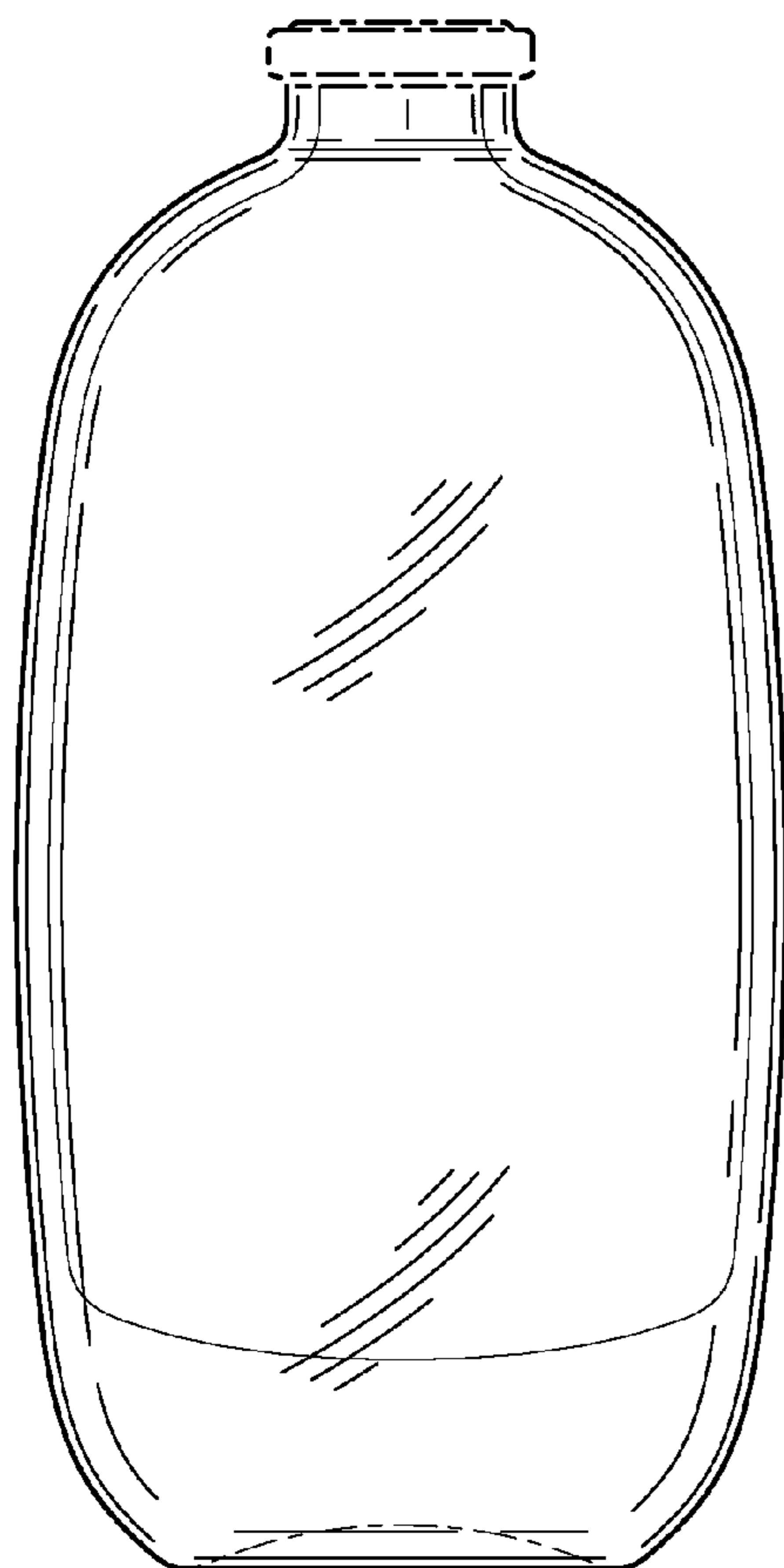

FIG. 2

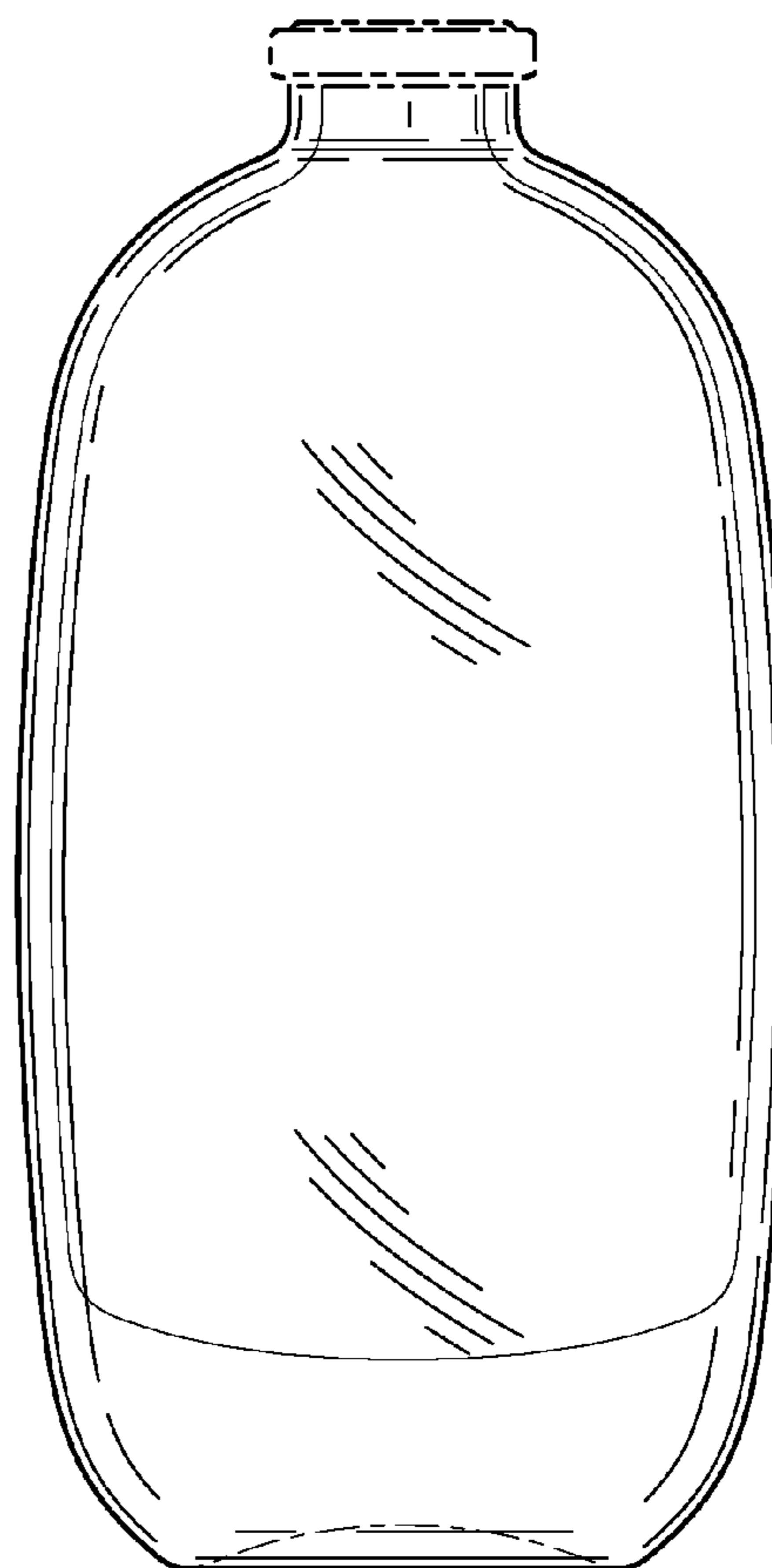

FIG. 3

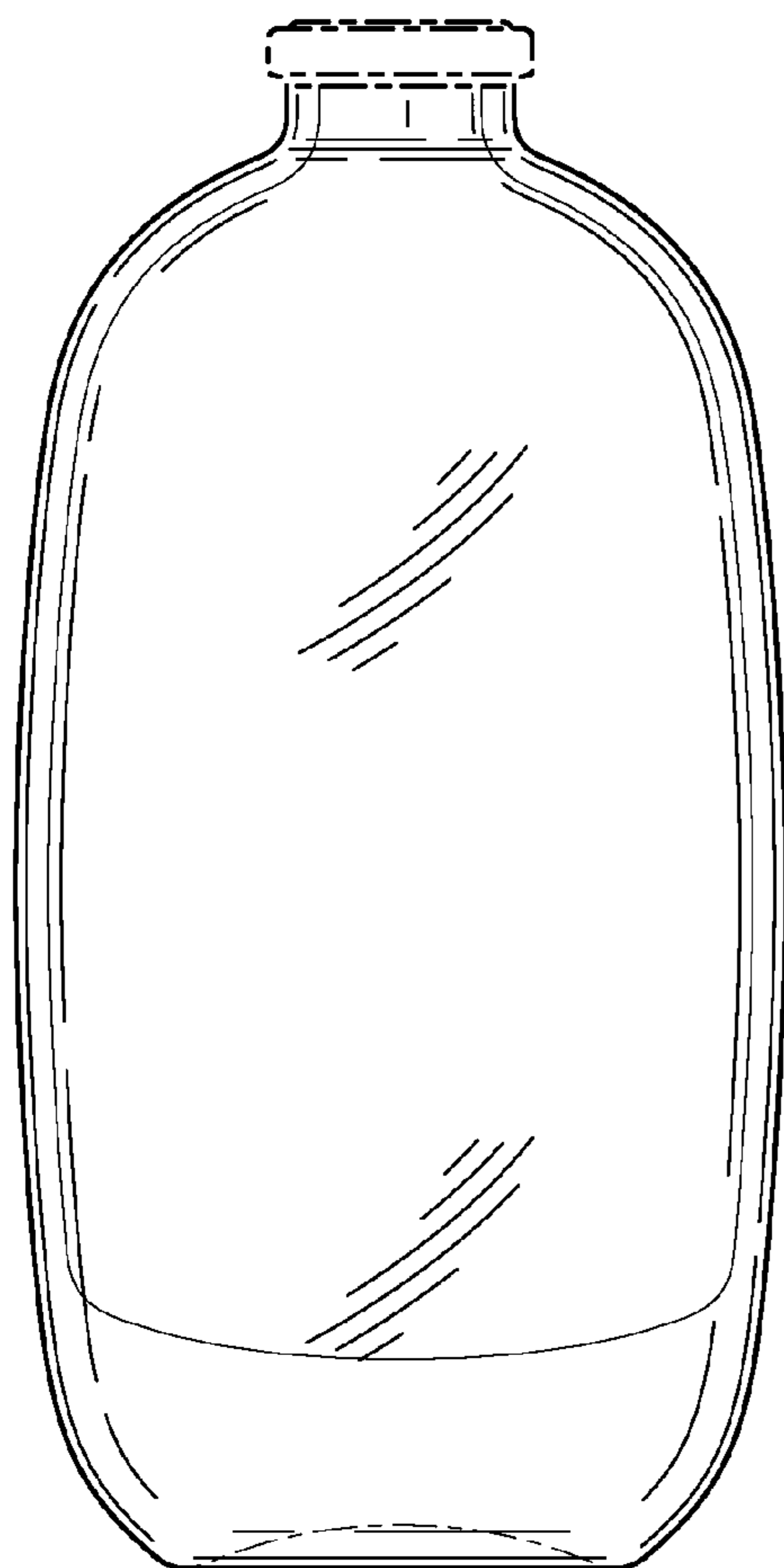

FIG. 4

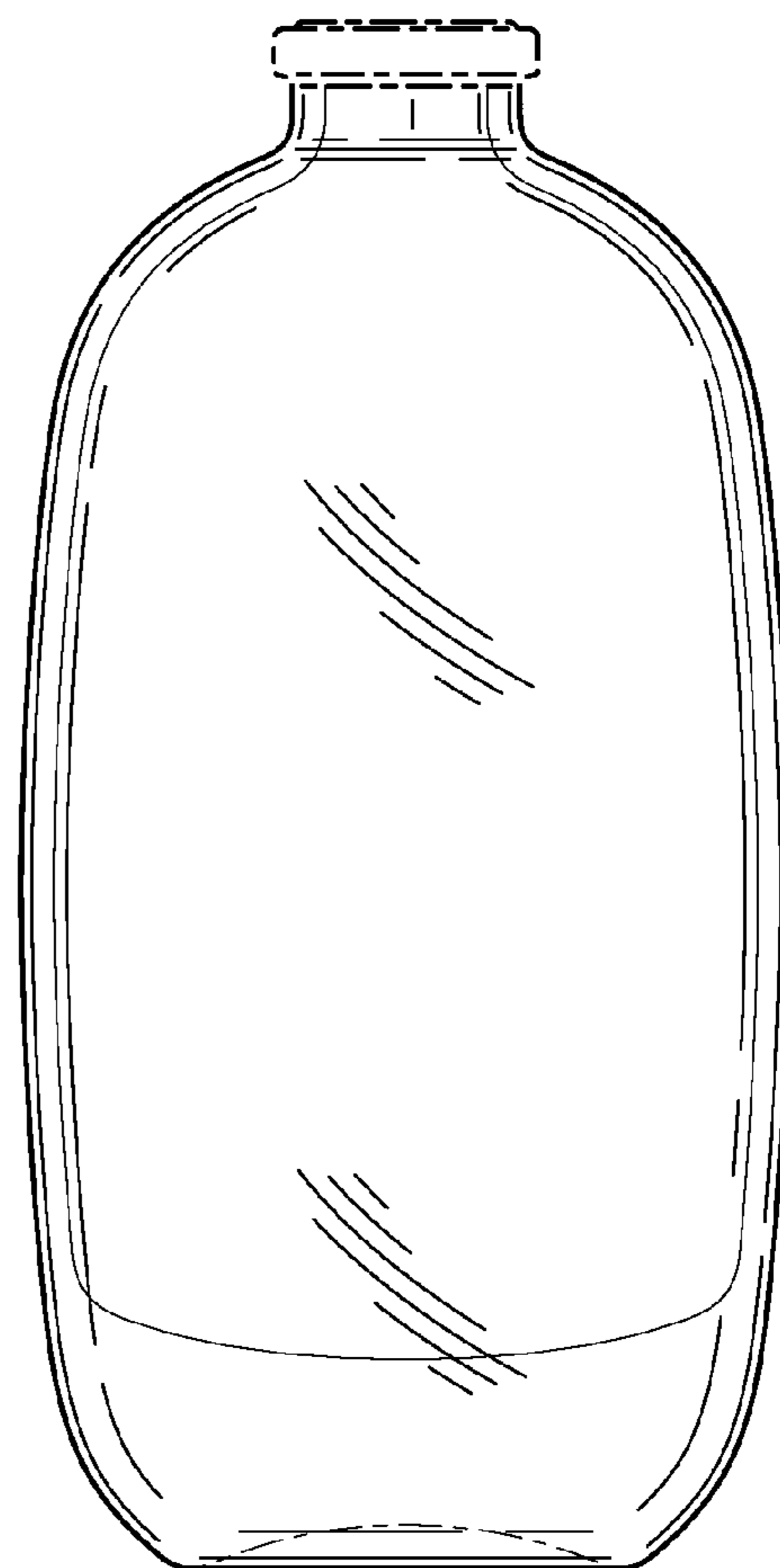

FIG. 5

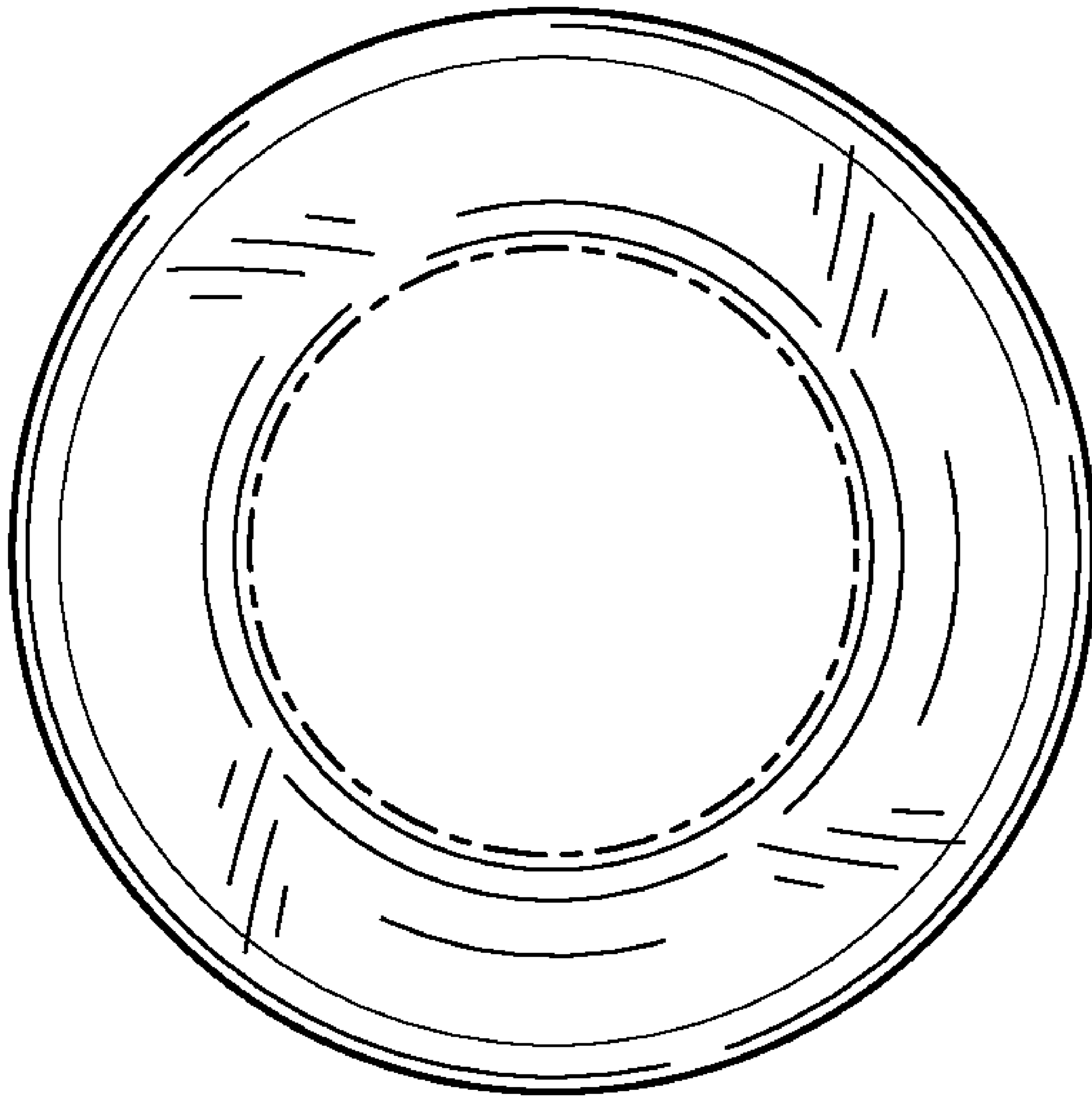

FIG. 7

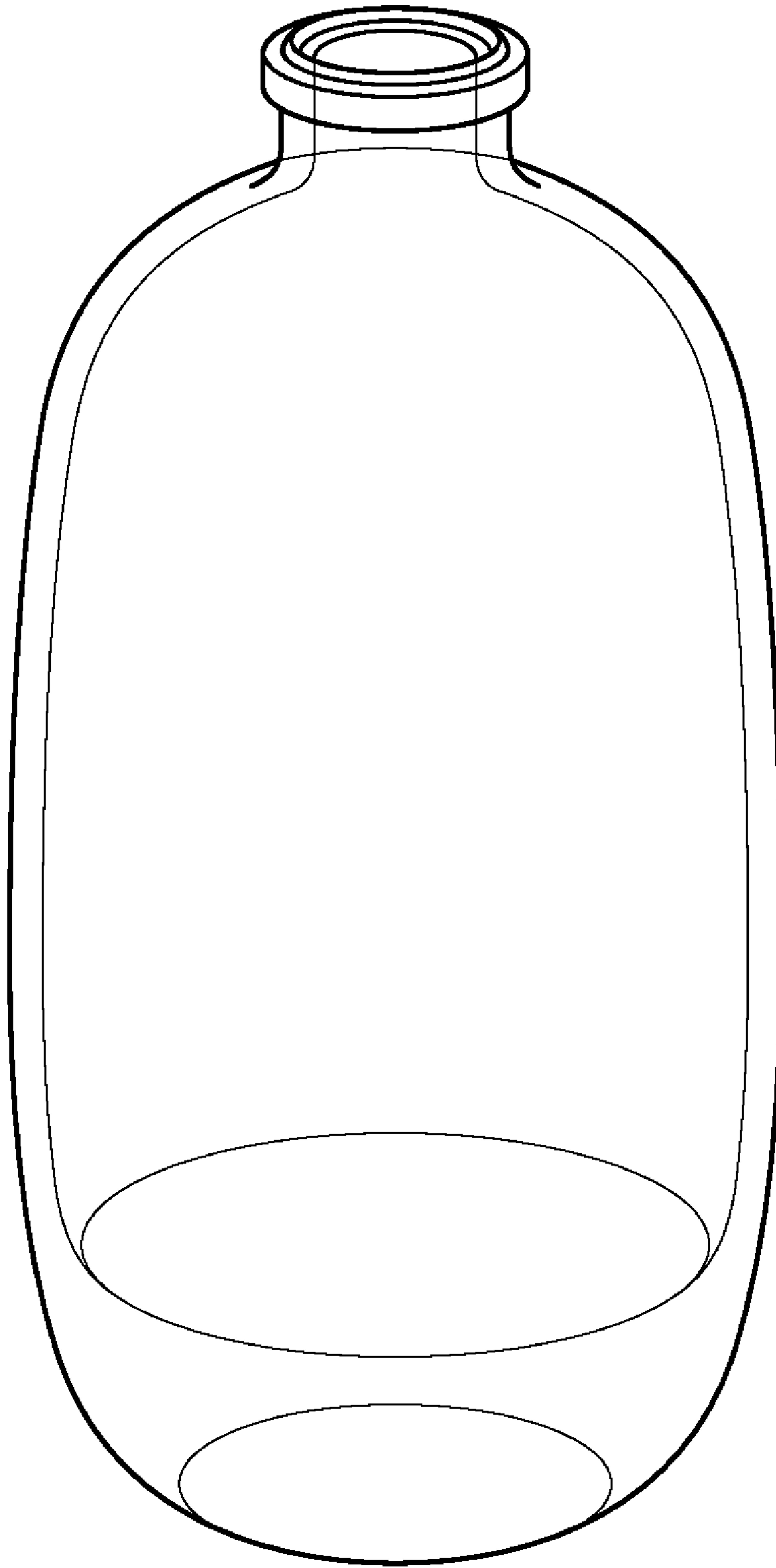

FIG. 8

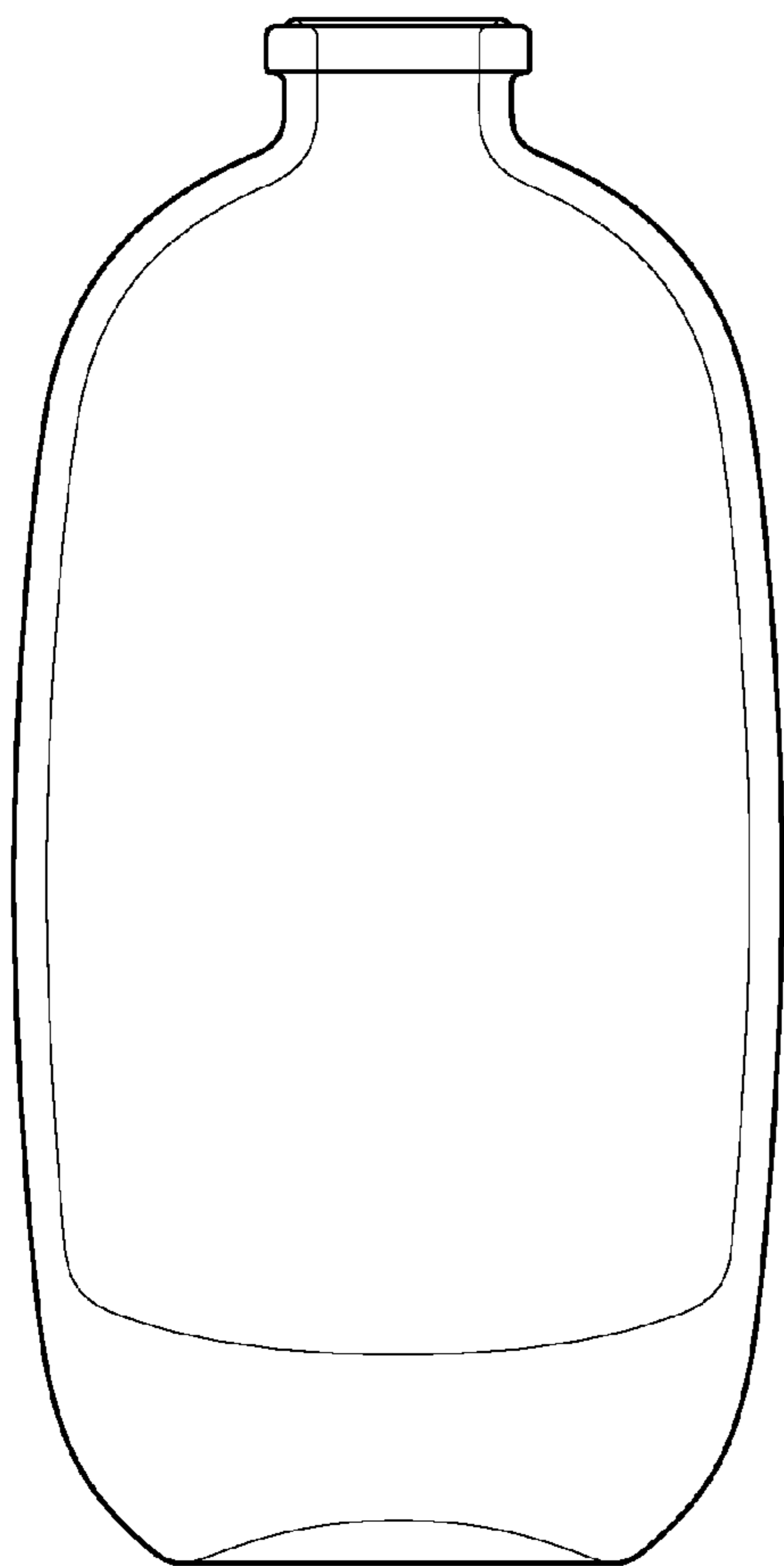

FIG. 9

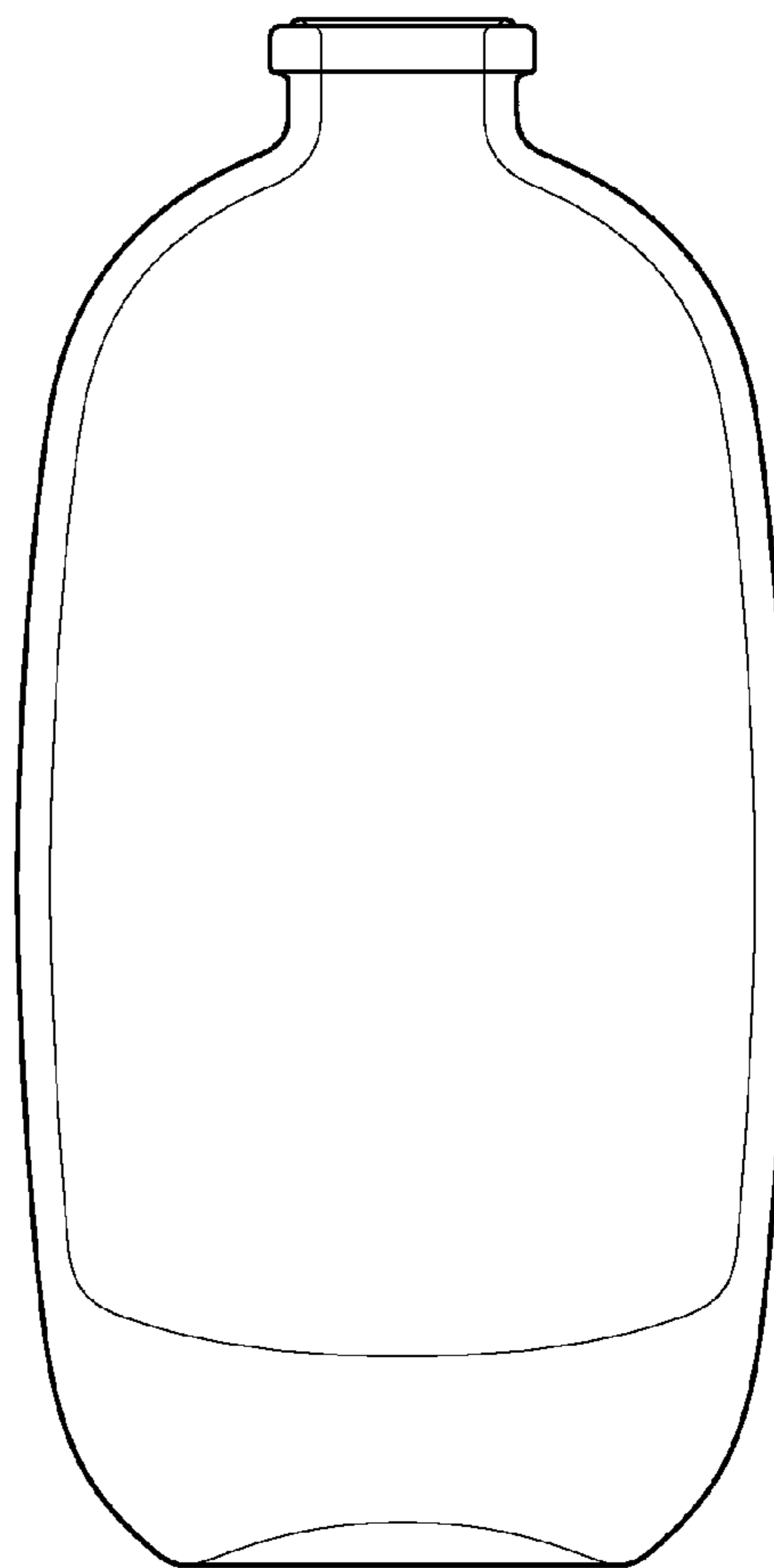

FIG. 10

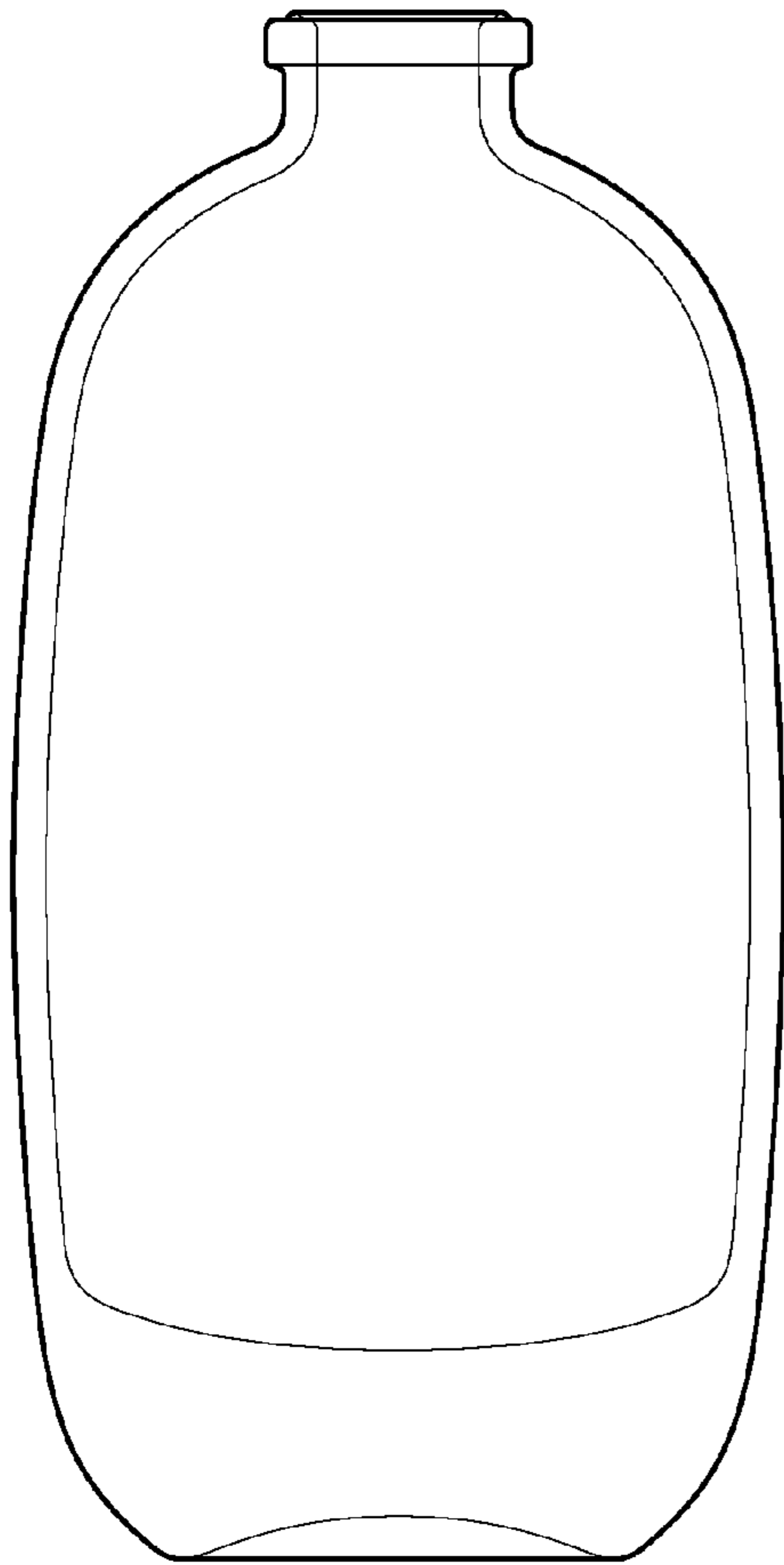

FIG. 11

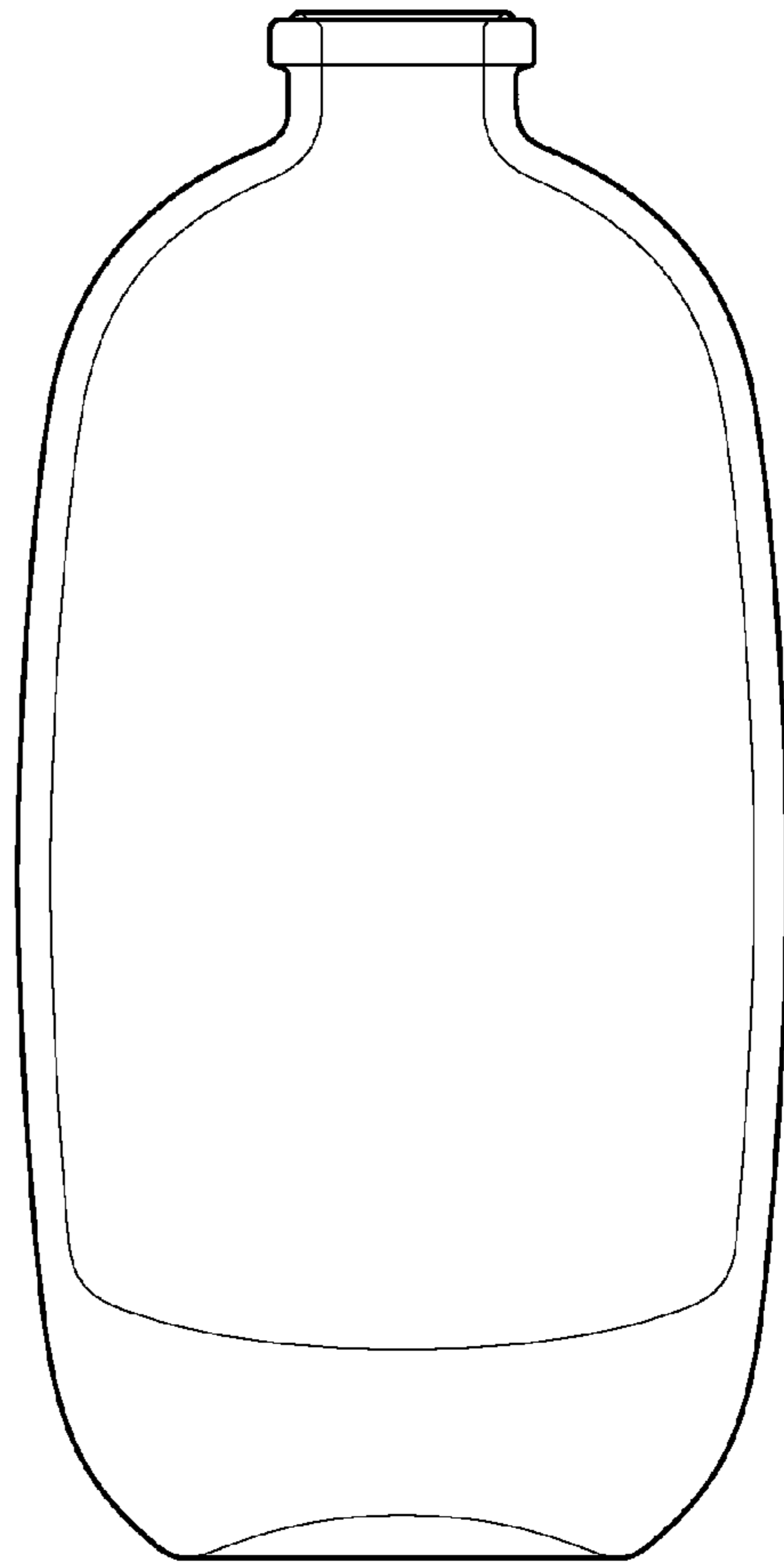

FIG. 12



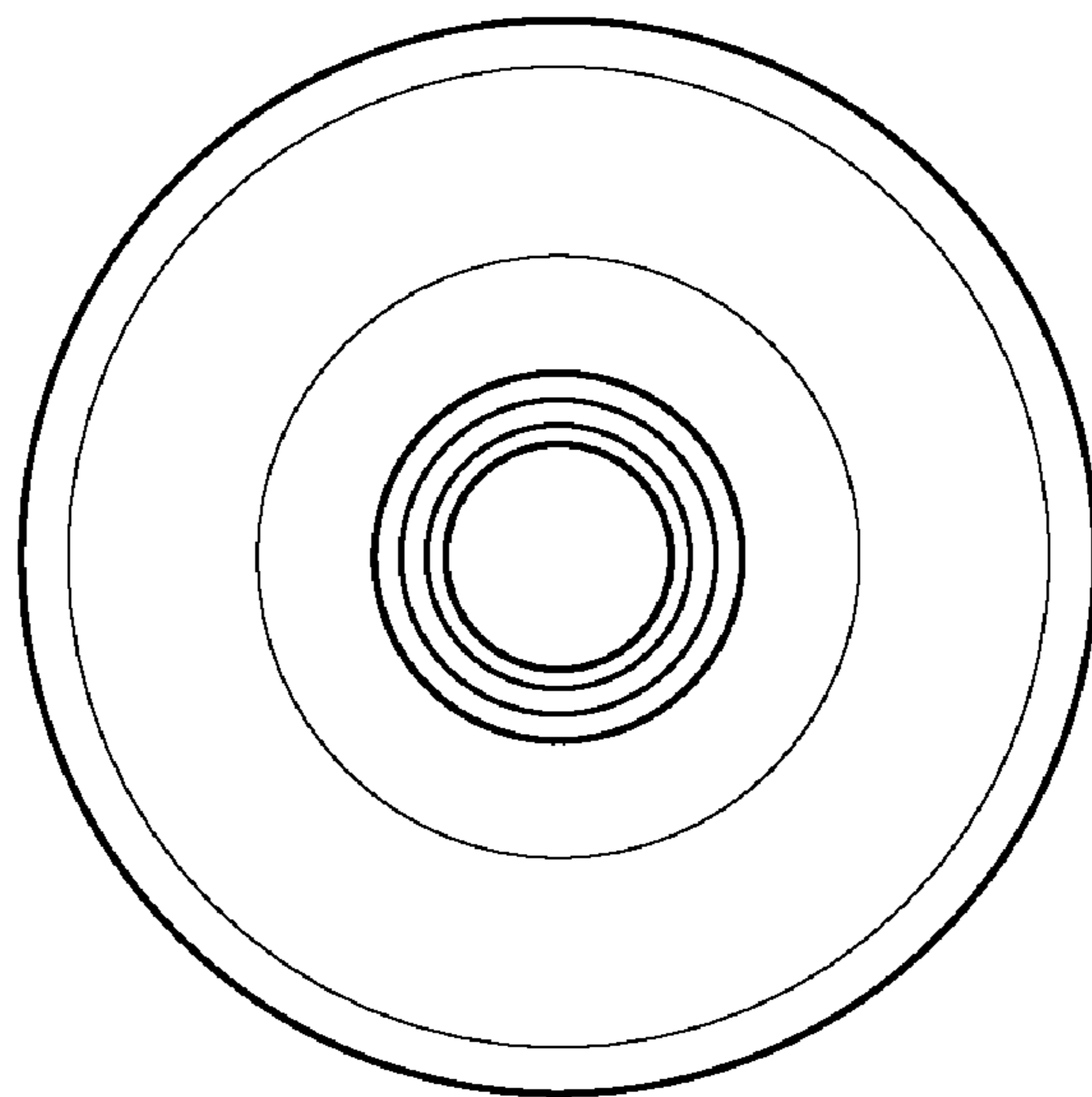

FIG. 13

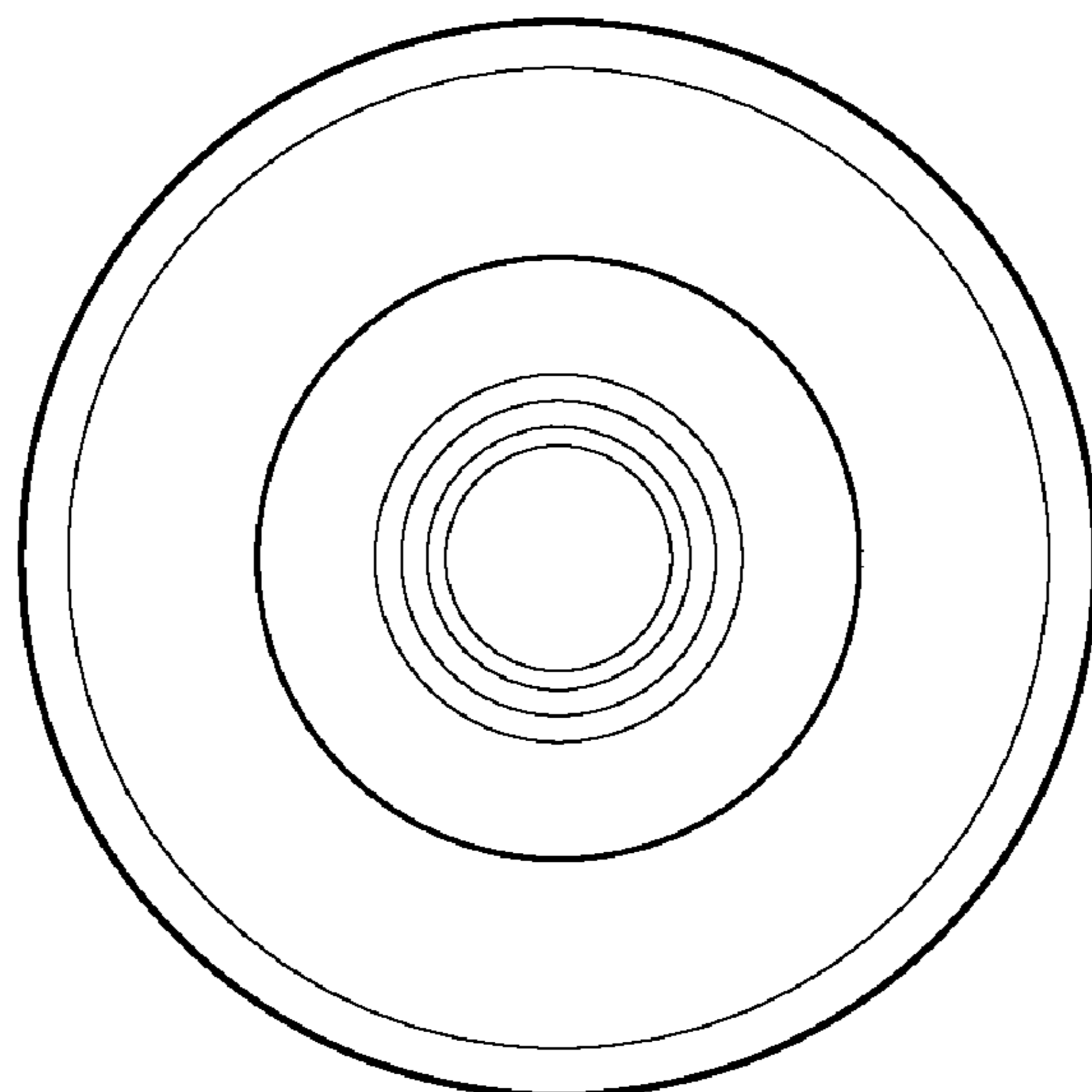

FIG. 14

UNITED STATES PATENT AND TRADEMARK OFFICE  
**CERTIFICATE OF CORRECTION**

PATENT NO. : D629,692 S  
APPLICATION NO. : 29/345661  
DATED : December 28, 2010  
INVENTOR(S) : Richard Lauret

Page 1 of 9

It is certified that error appears in the above-identified patent and that said Letters Patent is hereby corrected as shown below:

Drawings.

Drawing Sheets 1 through 8 have been deleted and substituted with the Drawings Sheets consisting of Figs. 1-14, as shown on the attached pages.

Signed and Sealed this  
Seventh Day of June, 2011

A handwritten signature in black ink that reads "David J. Kappos". The signature is written in a cursive style with a large, stylized 'D' and 'K'.

David J. Kappos  
*Director of the United States Patent and Trademark Office*

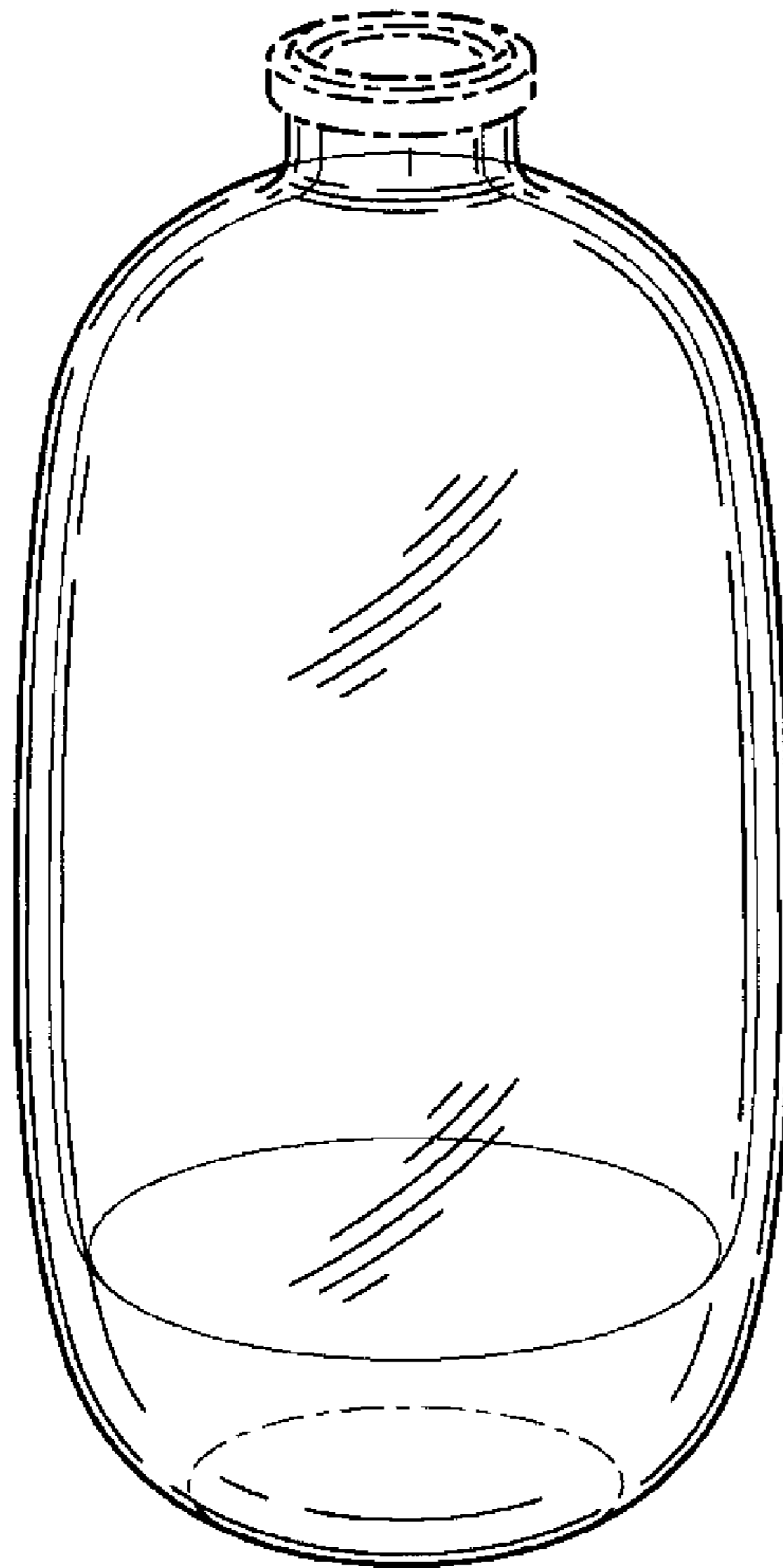

FIG. 1

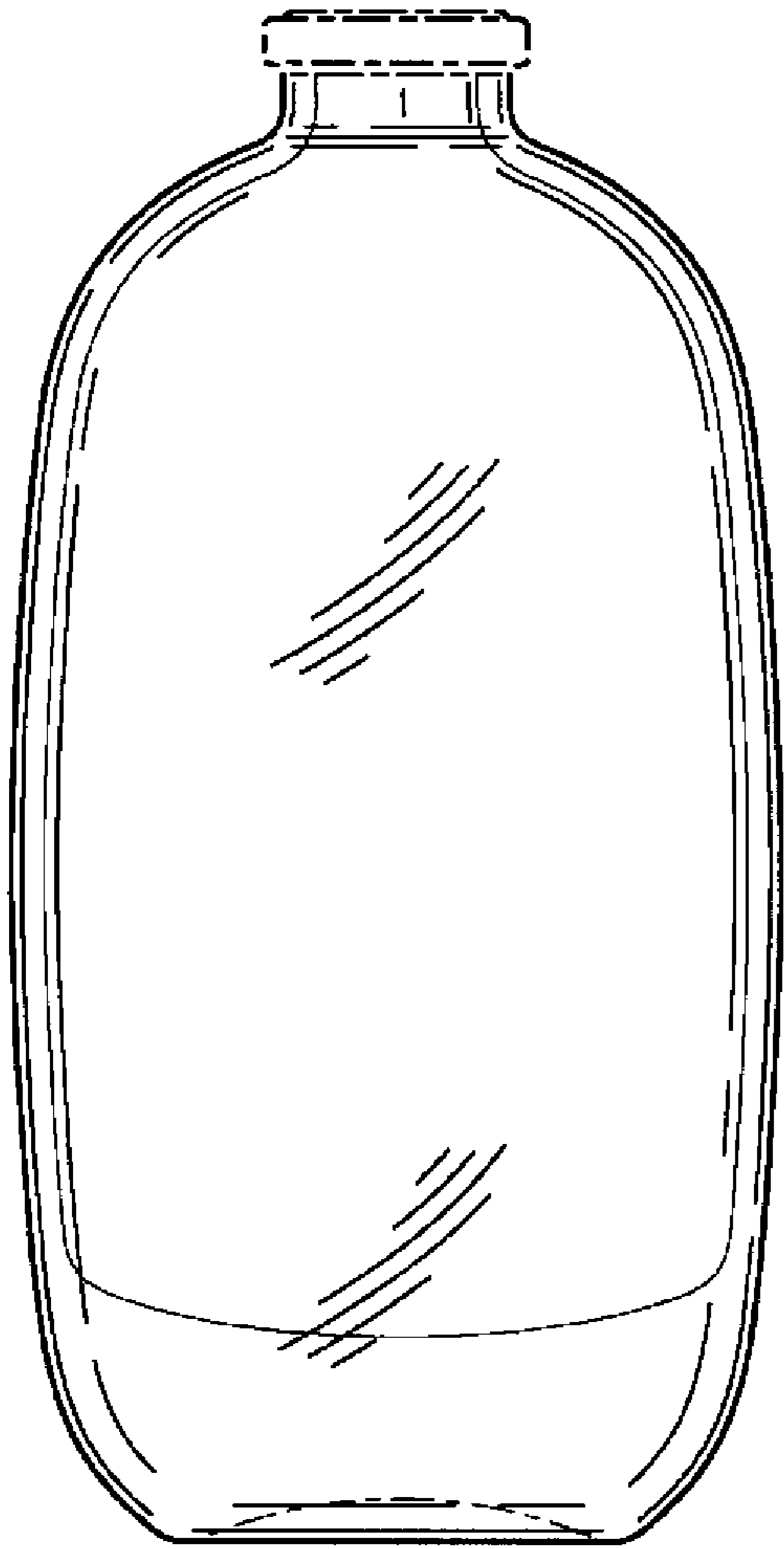

FIG. 2

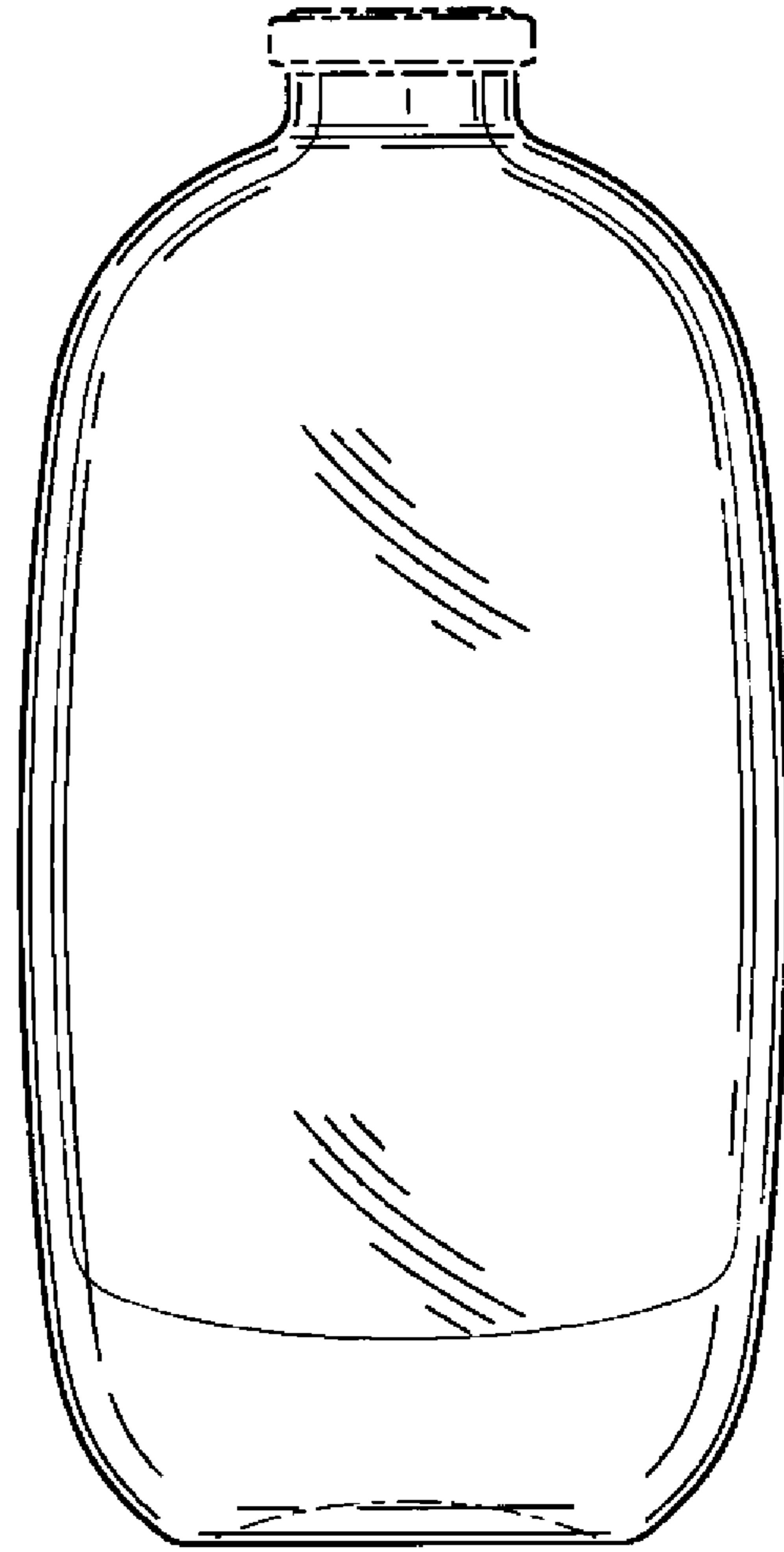

FIG. 3

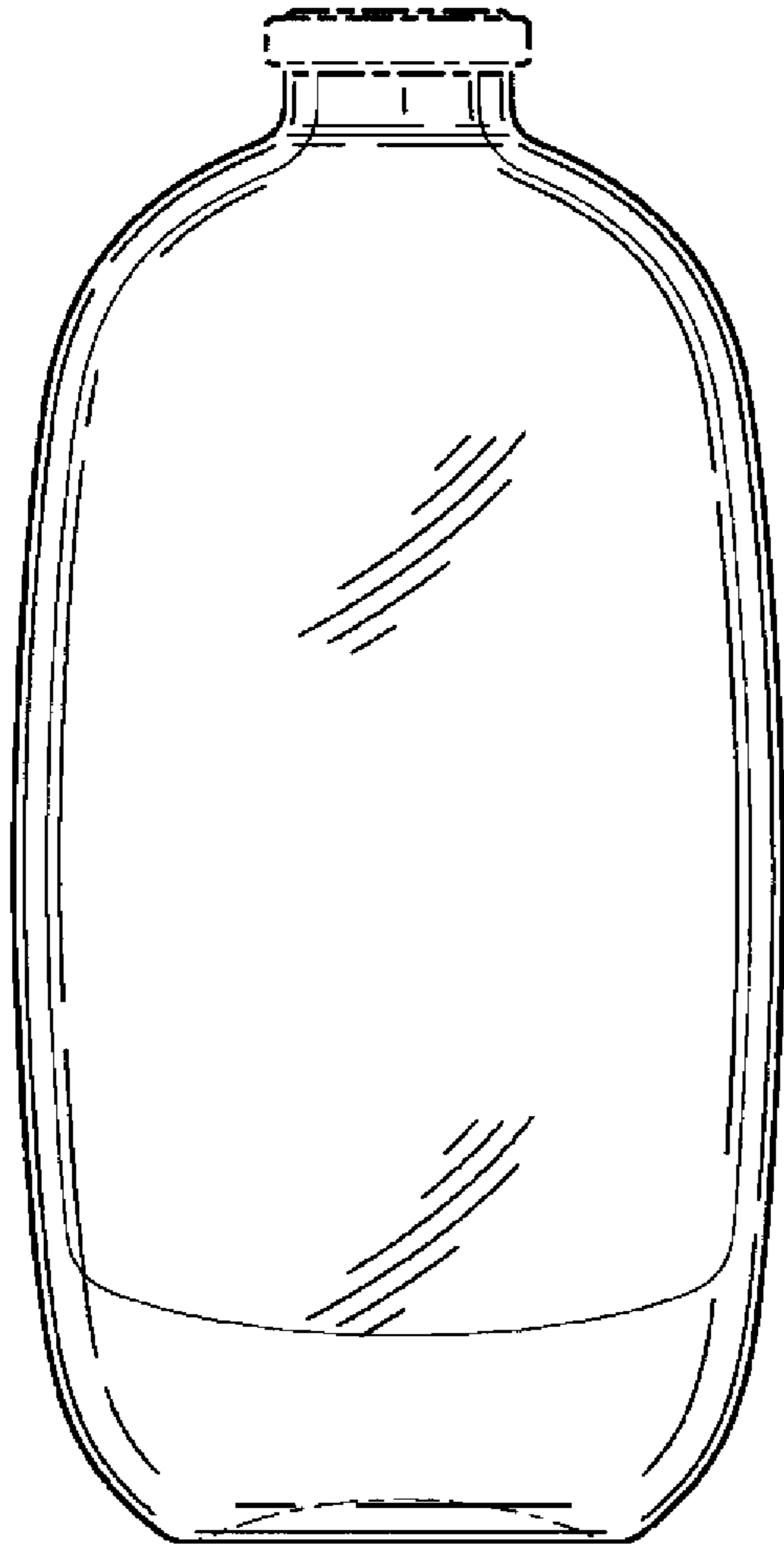

FIG. 4

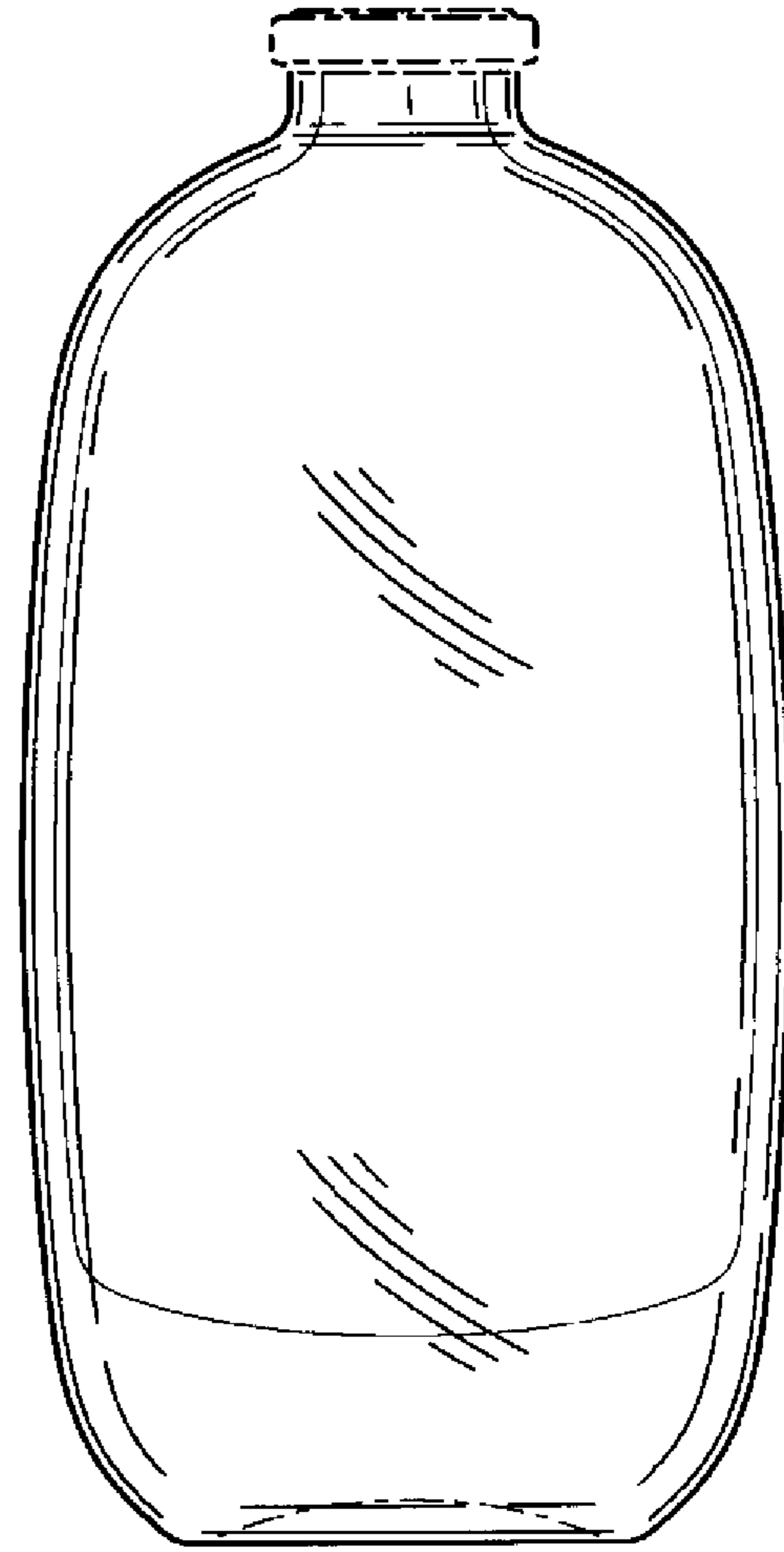

FIG. 5

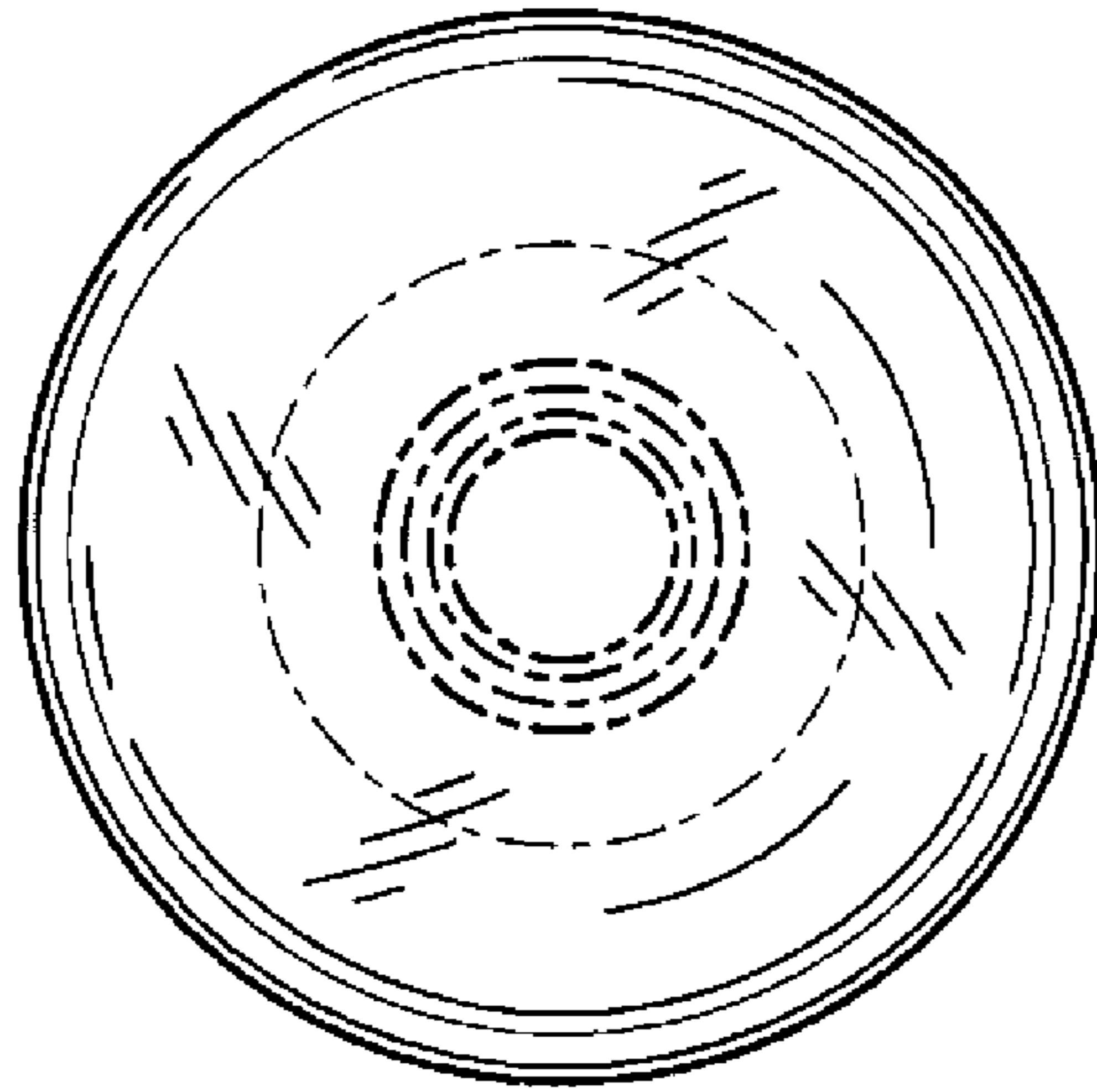

FIG. 6

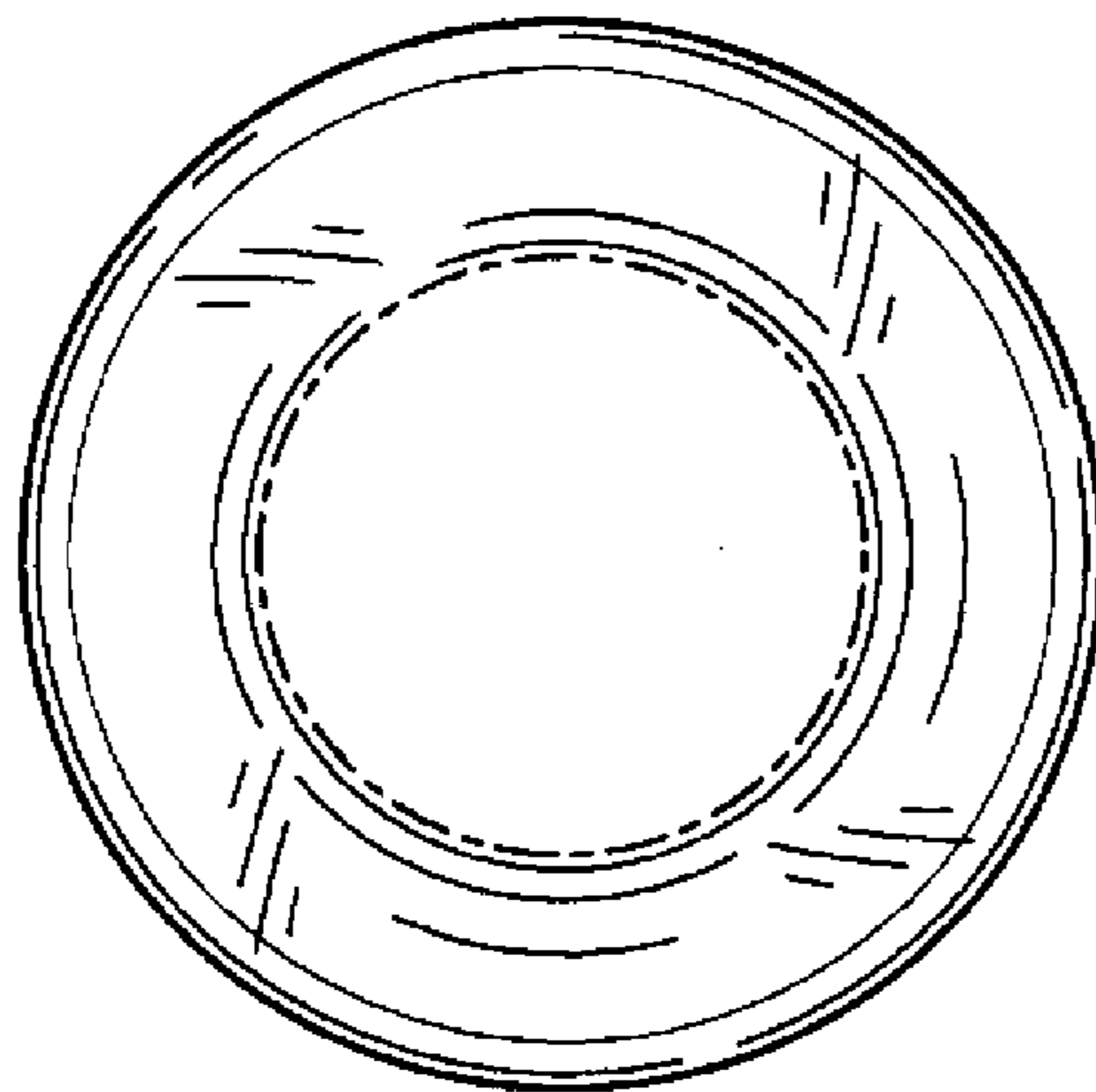

FIG. 7

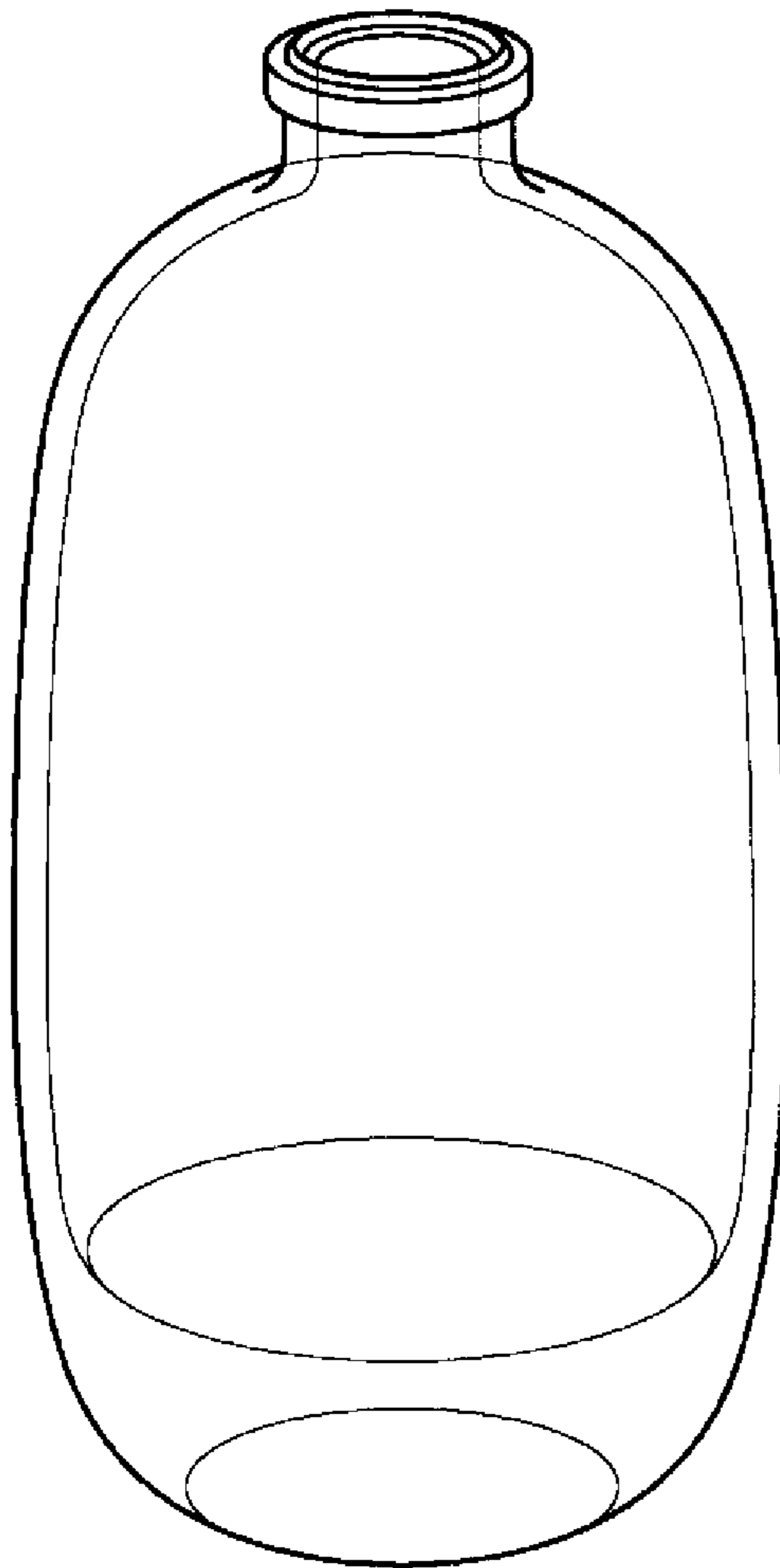

FIG. 8

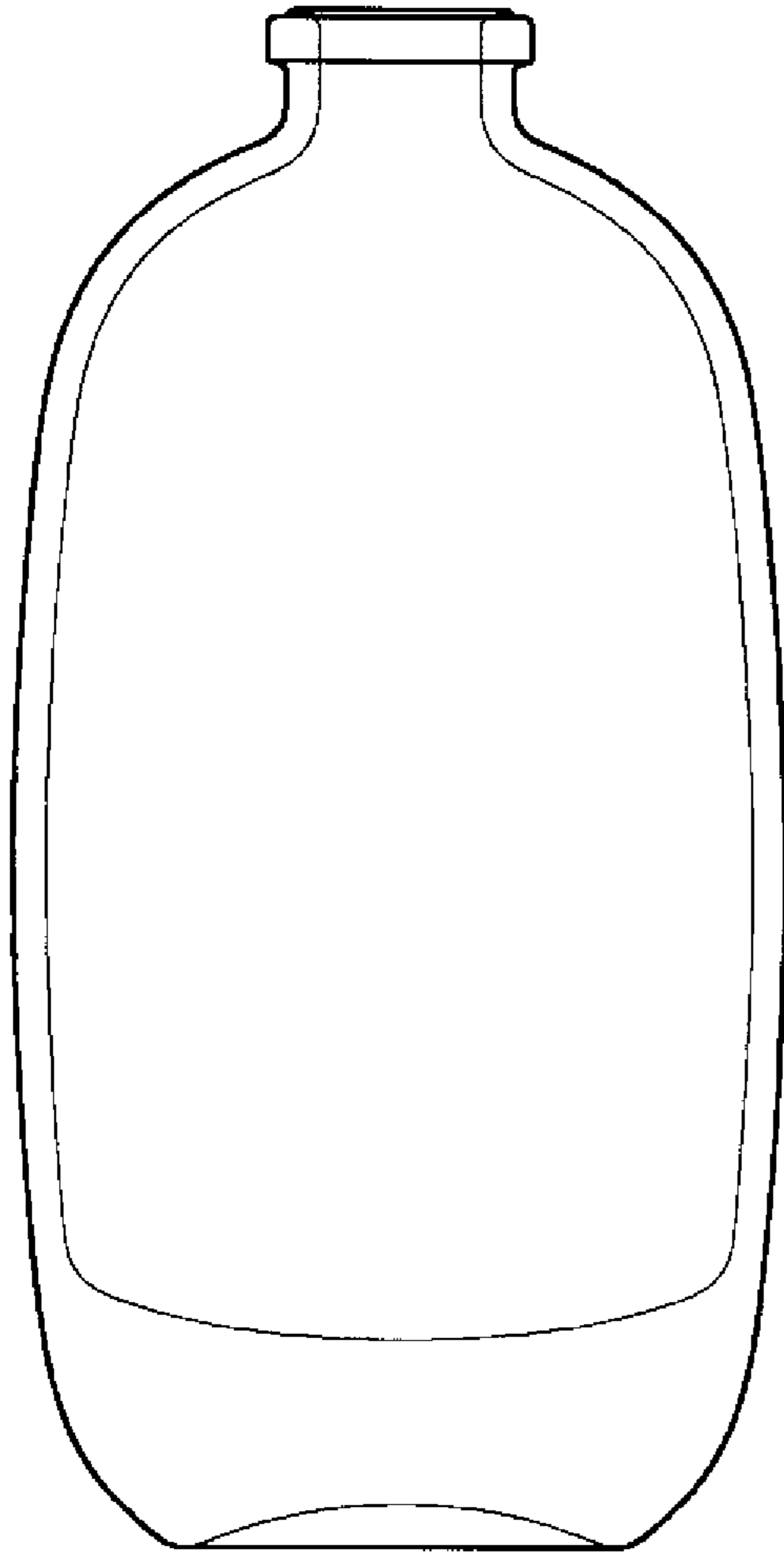

FIG. 9

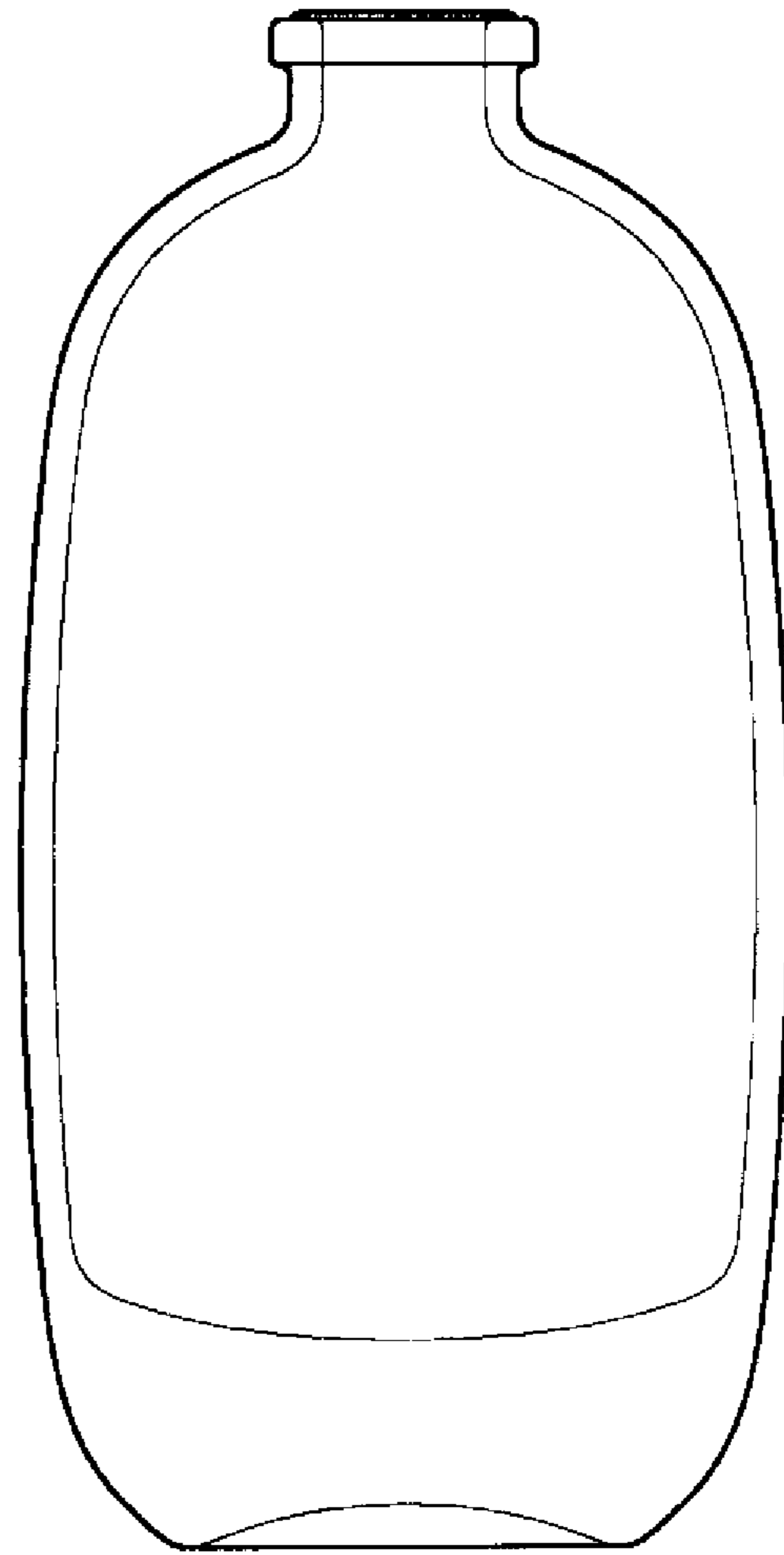

FIG. 10



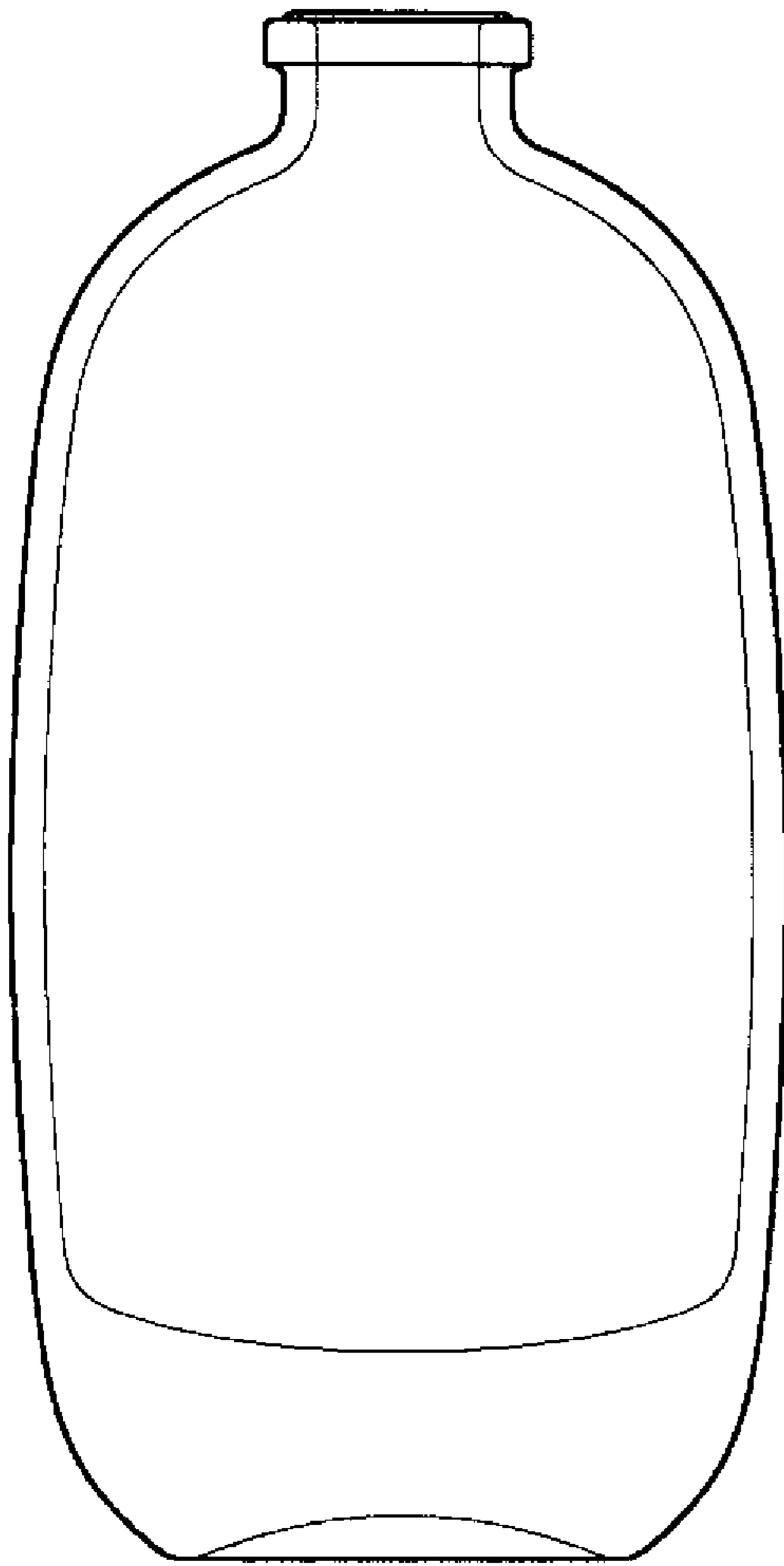

FIG. 11

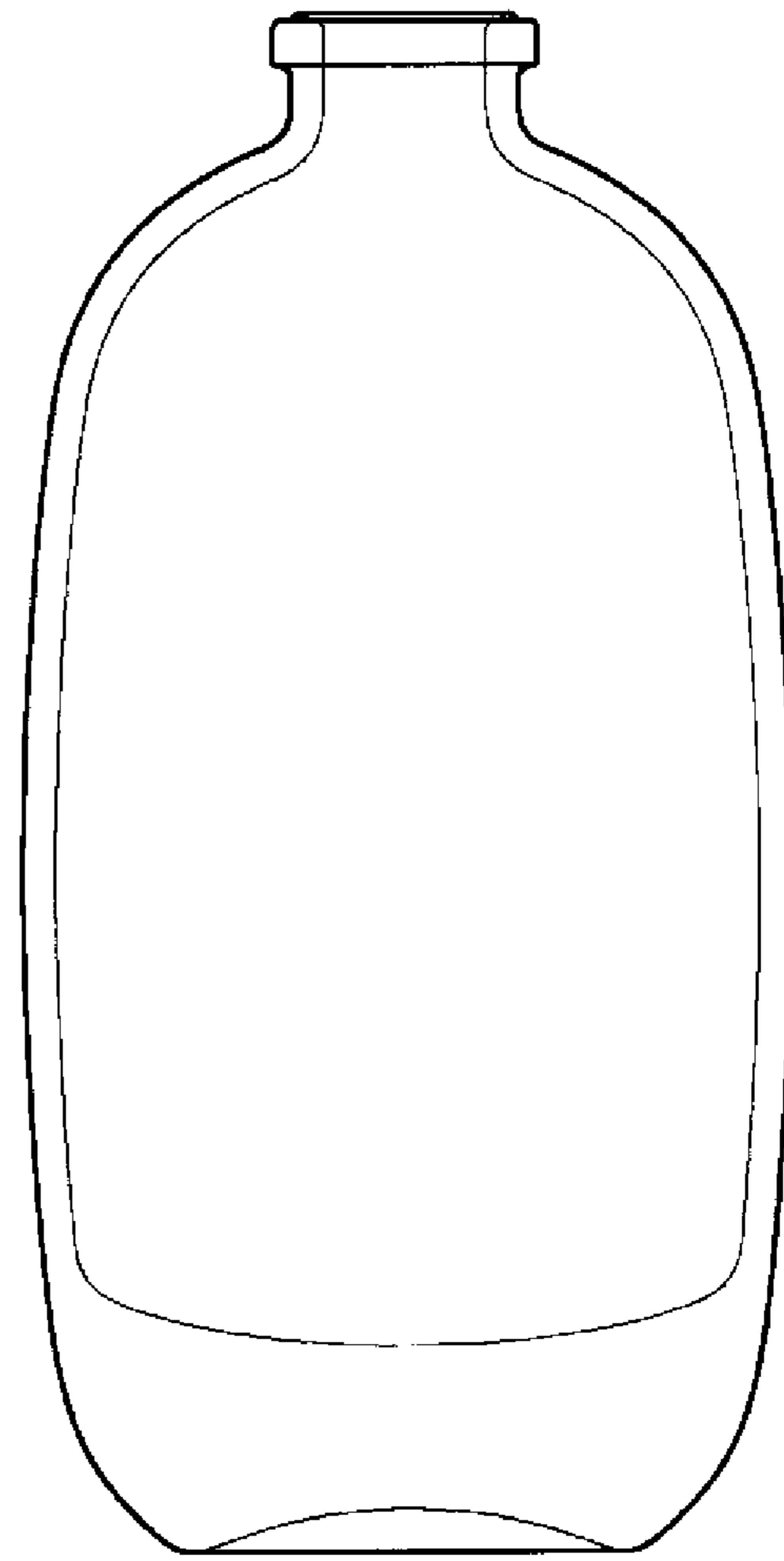

FIG. 12

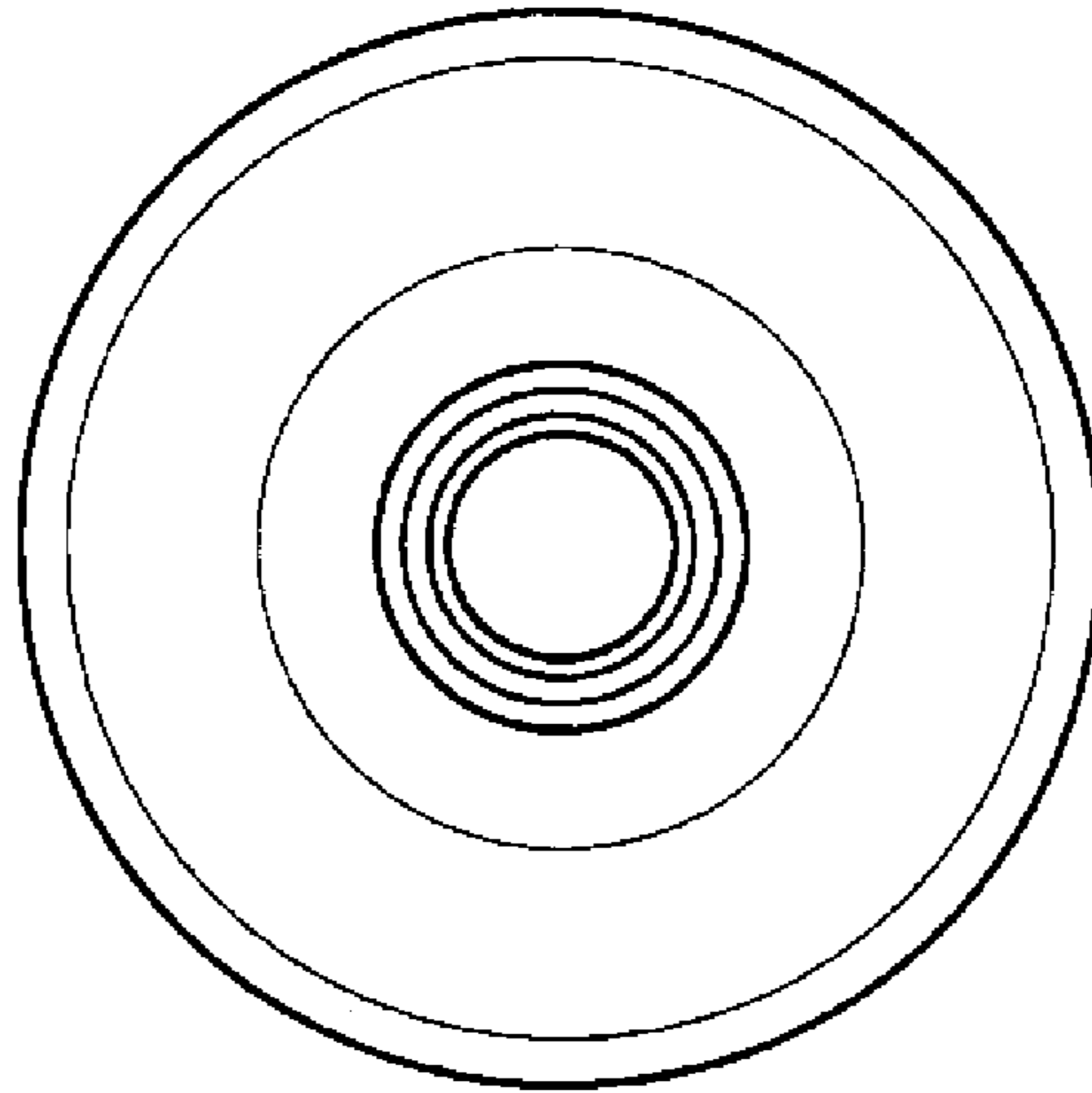

FIG. 13

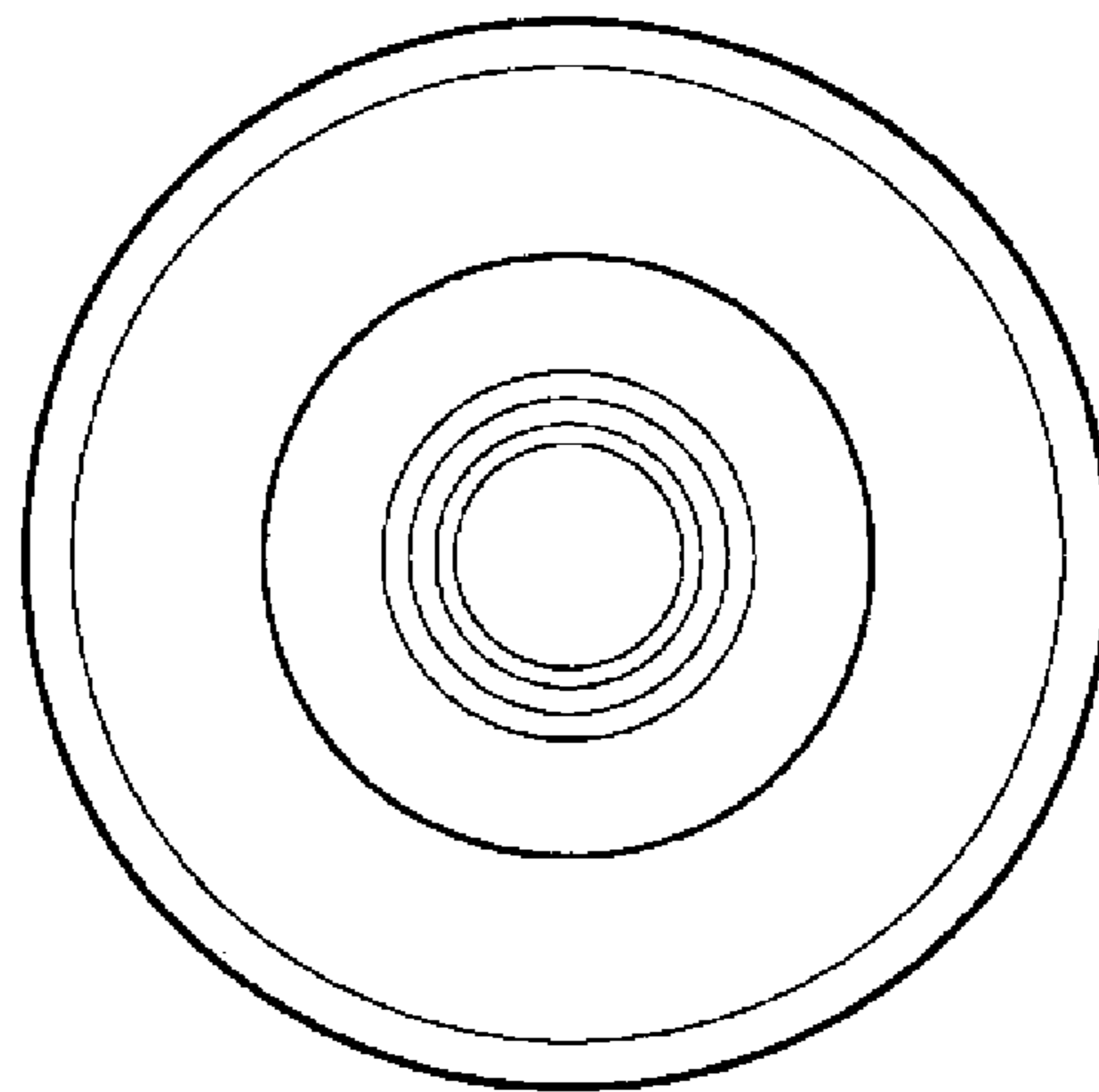

FIG. 14