



US00D629686S

(12) **United States Design Patent**  
**Velazquez**

(10) **Patent No.:** **US D629,686 S**

(45) **Date of Patent:** **\*\* Dec. 28, 2010**

(54) **BEVERAGE CASE**

(75) Inventor: **Jesse Velazquez**, Bell, CA (US)

(73) Assignee: **Amfoam, Inc.**, Los Angeles, CA (US)

(\*\*) Term: **14 Years**

(21) Appl. No.: **29/342,472**

(22) Filed: **Aug. 25, 2009**

**Related U.S. Application Data**

(63) Continuation-in-part of application No. 29/337,680, filed on May 27, 2009.

(51) **LOC (9) Cl.** ..... **09-07**

(52) **U.S. Cl.** ..... **D9/456**

(58) **Field of Classification Search** ..... D7/601-602, D7/701, 703, 708, 619.1, 620; D9/501, 517, D9/434, 455-456, 499; D34/28, 38; D6/449, D6/475; 211/74; 206/427, 429, 433, 503  
See application file for complete search history.

(56) **References Cited**

**U.S. PATENT DOCUMENTS**

D301,013	S	*	5/1989	Creaden	.....	D9/456
D328,034	S	*	7/1992	Creaden	.....	D9/456
D332,571	S	*	1/1993	Creaden	.....	D9/456
D400,441	S	*	11/1998	Warren	.....	D9/456
D403,961	S	*	1/1999	Warren	.....	D9/456

\* cited by examiner

*Primary Examiner*—Carol Rademaker

*Assistant Examiner*—Dana L Sipos

(74) *Attorney, Agent, or Firm*—Hani Z. Sayed; Rutan & Tucker, LLP

(57) **CLAIM**

I claim the ornamental design for a beverage case, as shown and described.

**DESCRIPTION**

FIG. 1 is a top perspective view of a beverage case showing my new design;

FIG. 2 is a top plan view thereof;

FIG. 3 is a bottom plan view thereof;

FIG. 4 is a right side elevation view thereof;

FIG. 5 is a rear elevation view thereof;

FIG. 6 is a front elevation view thereof;

FIG. 7 is a cross-section view taken along the line 7—7 in FIG. 2;

FIG. 8 is a cross section view taken along the line 8—8 in FIG. 2;

FIG. 9 is an exploded top perspective view of the beverage case of the present design in use; and,

FIG. 10 is a top perspective view of the beverage case of the present design in use.

The broken lines in FIGS. 9 & 10 illustrate the portions of the design that form no part of the claim.

**1 Claim, 7 Drawing Sheets**

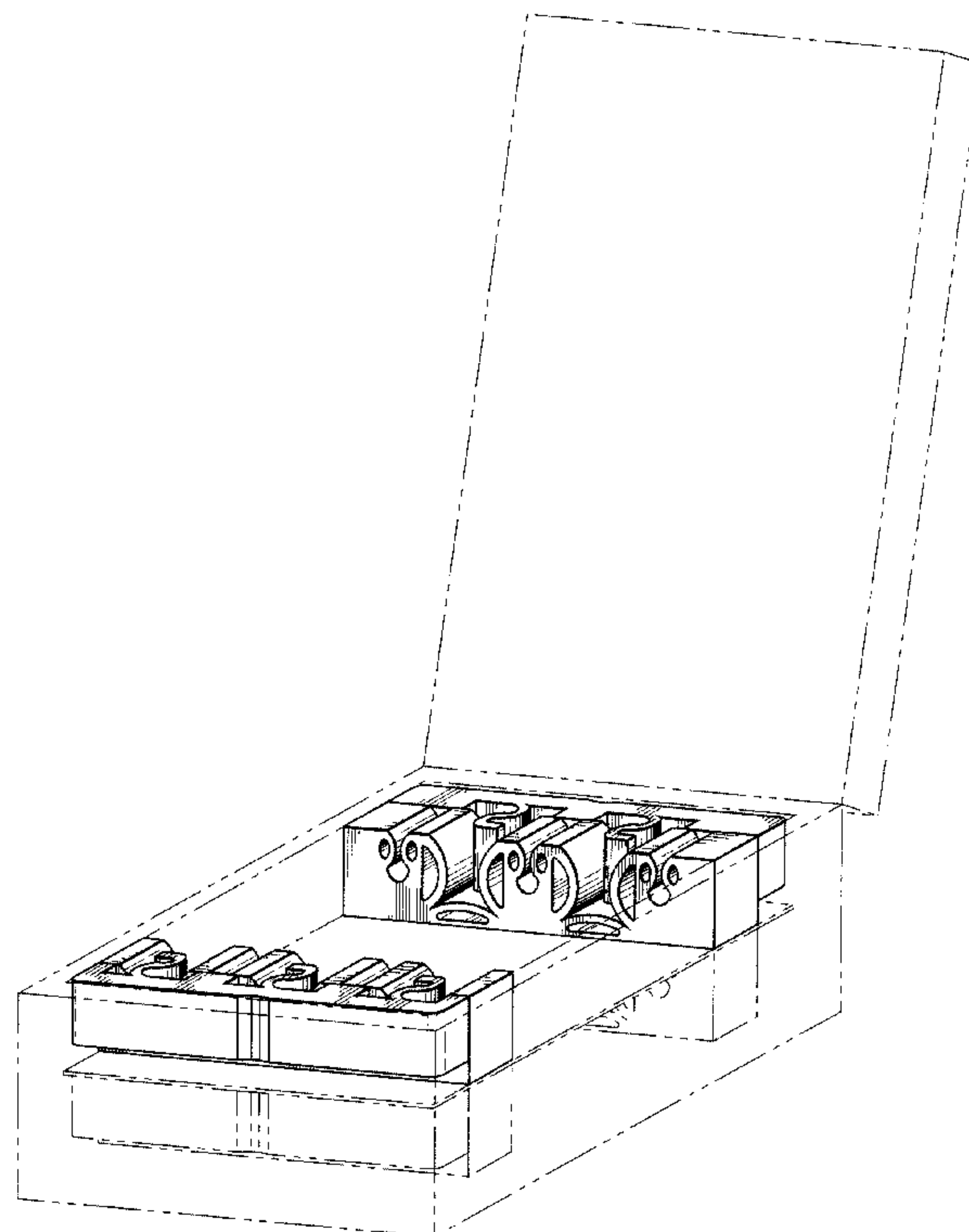

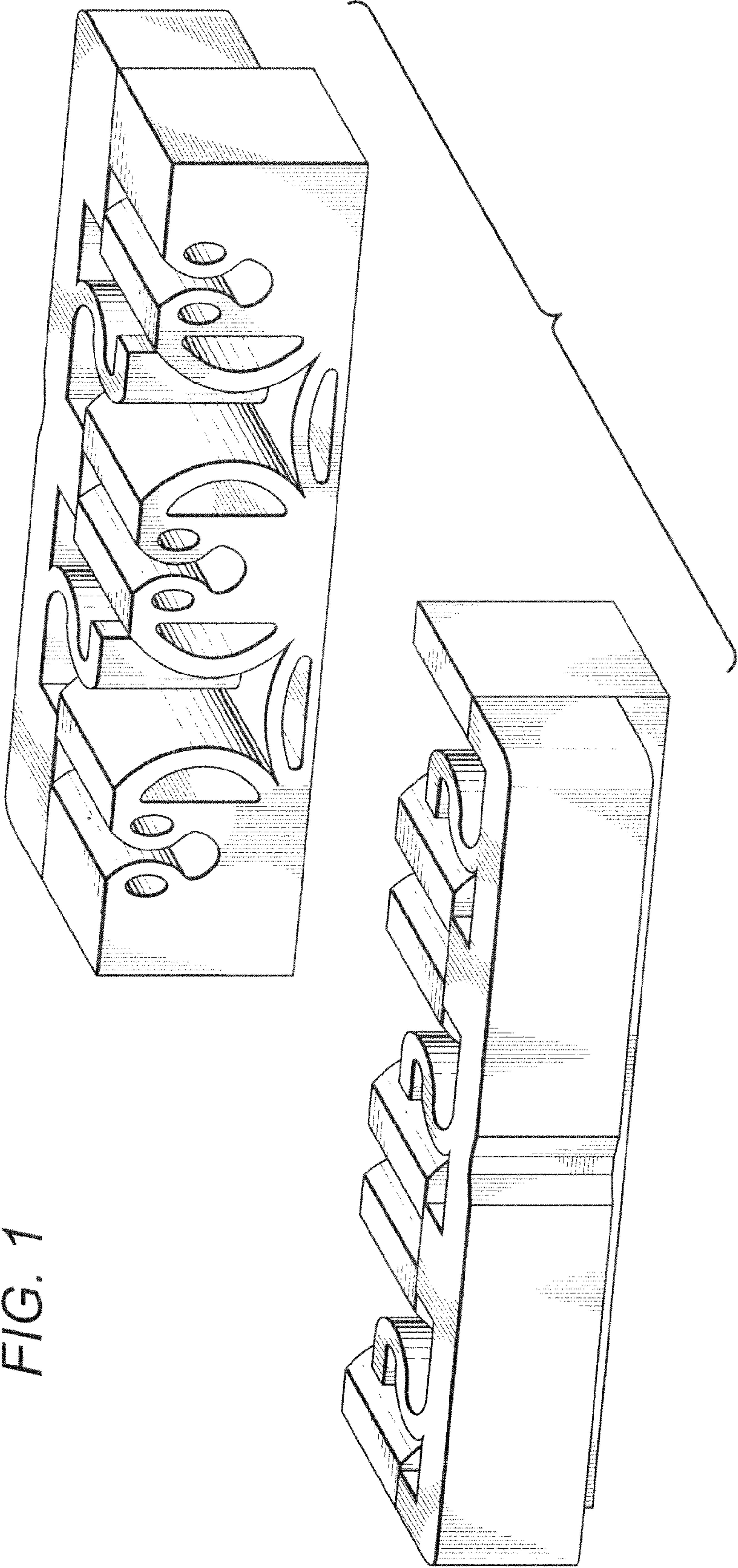

FIG. 1

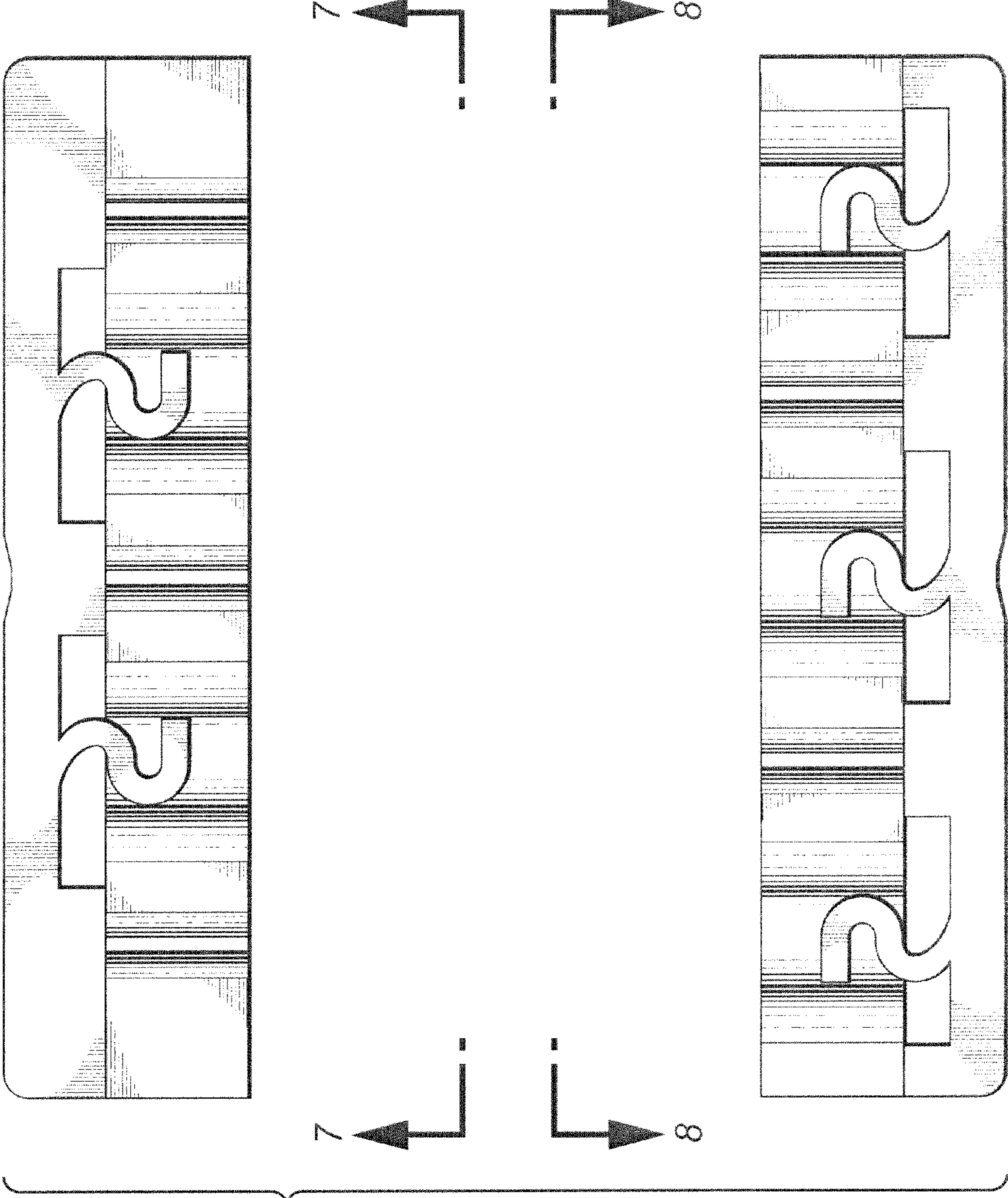

FIG. 2



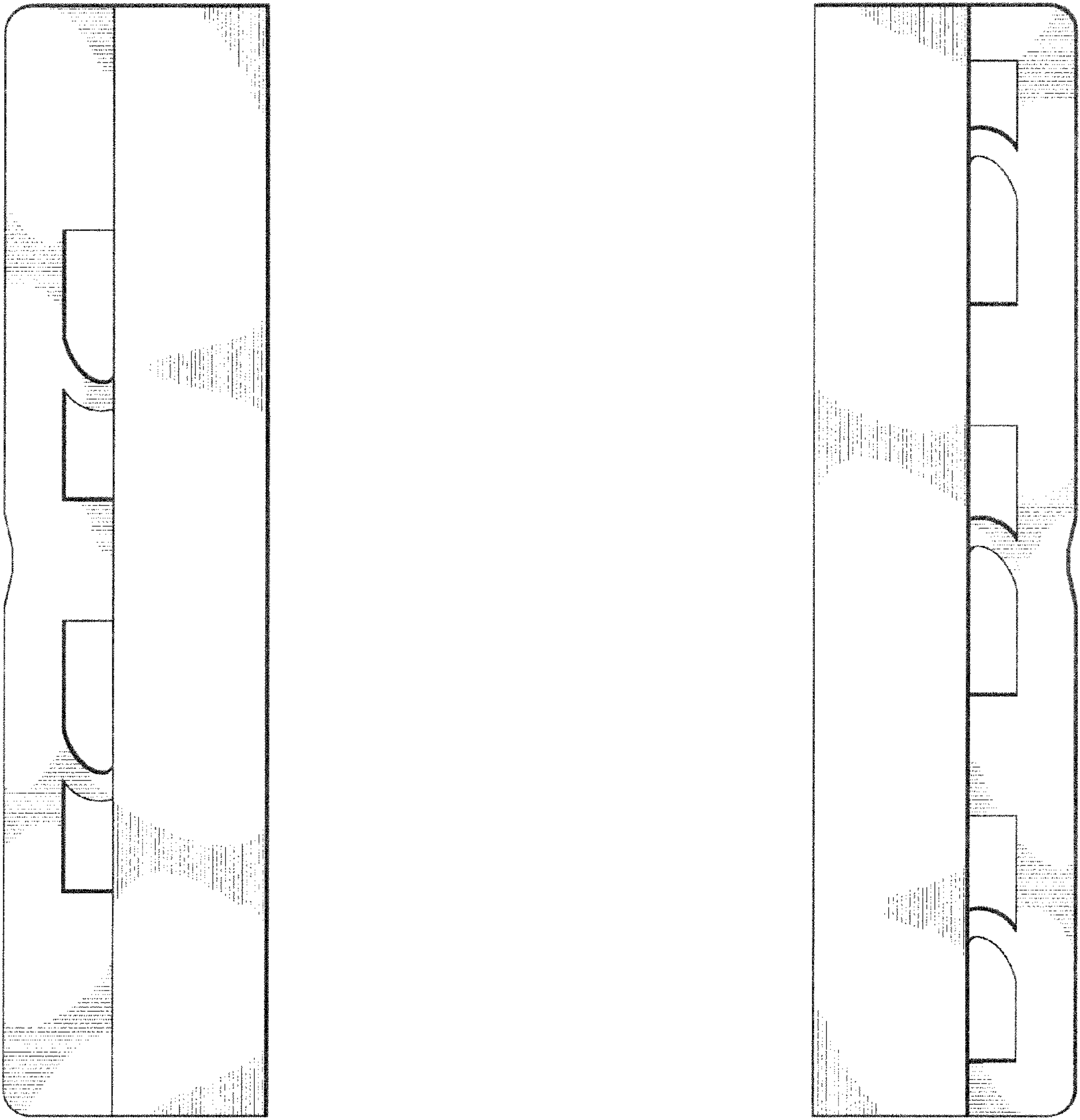

FIG.3

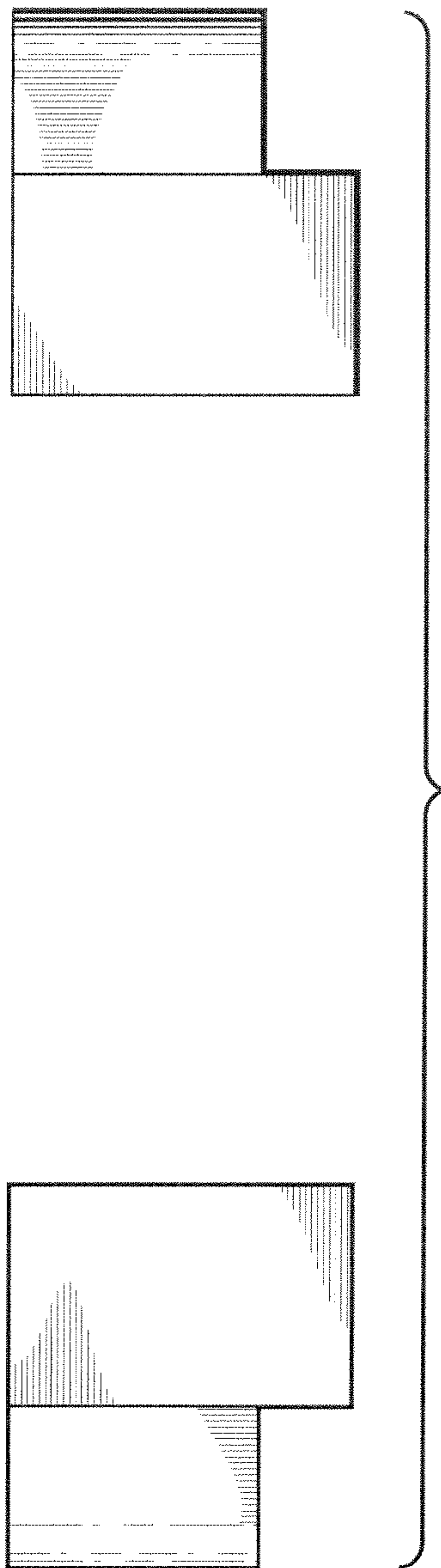
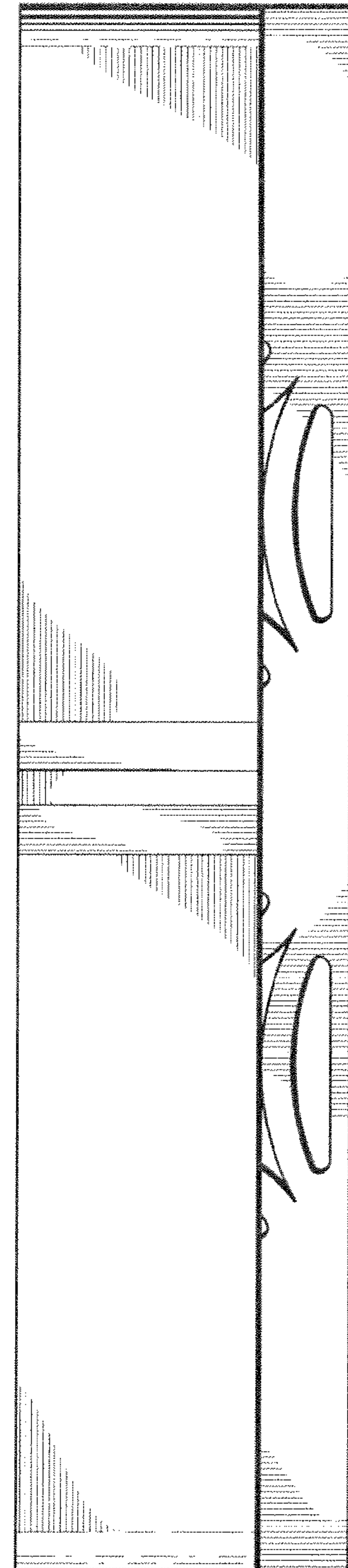

FIG. 4

FIG. 5



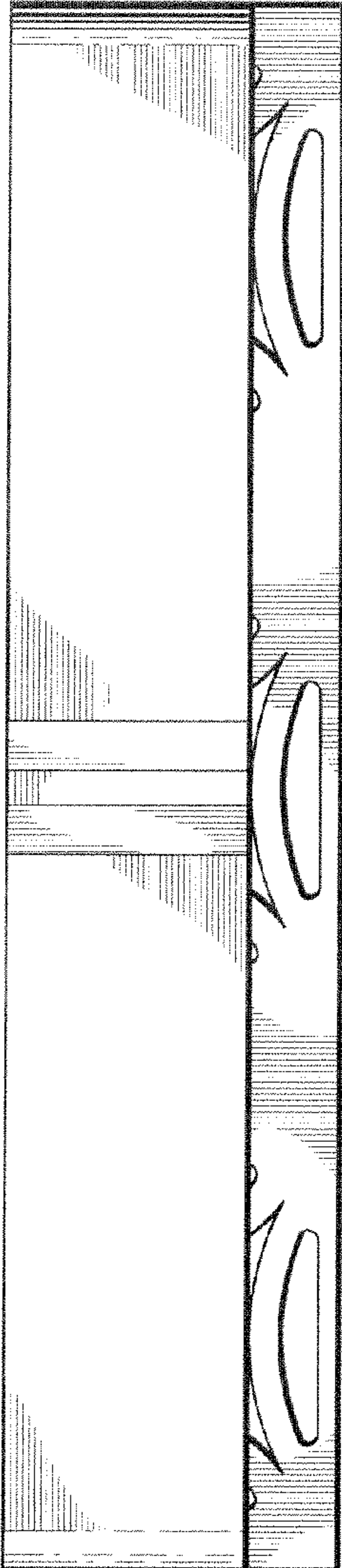

FIG. 6

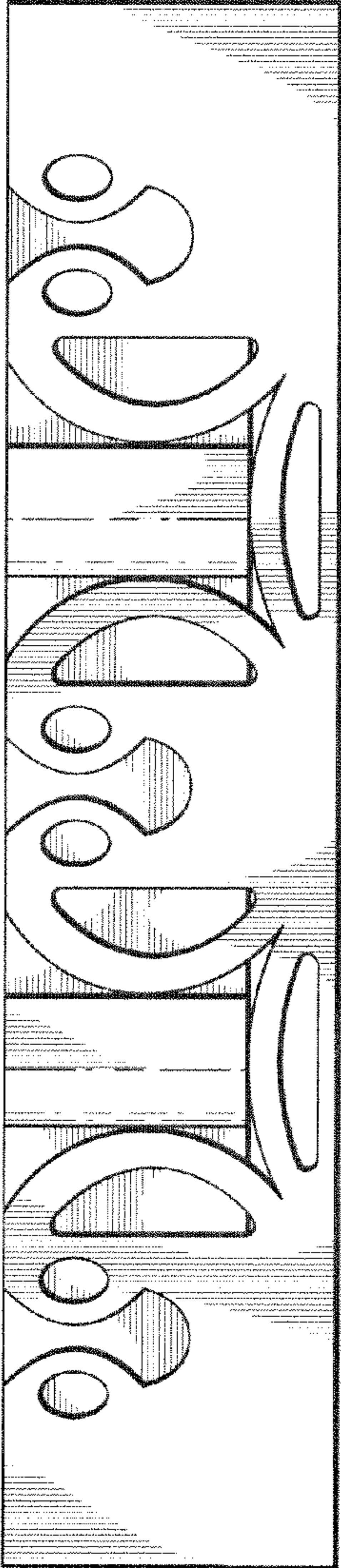

FIG. 7

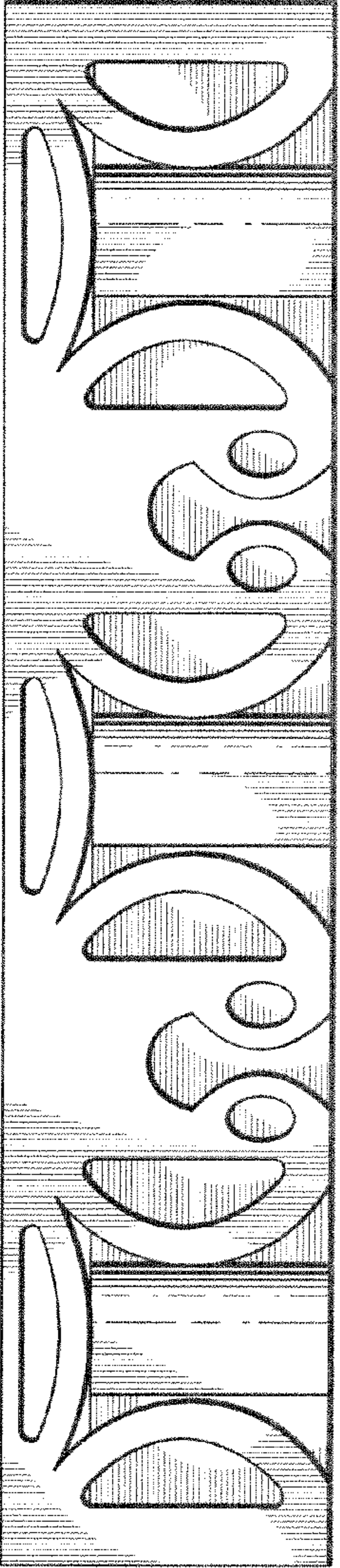
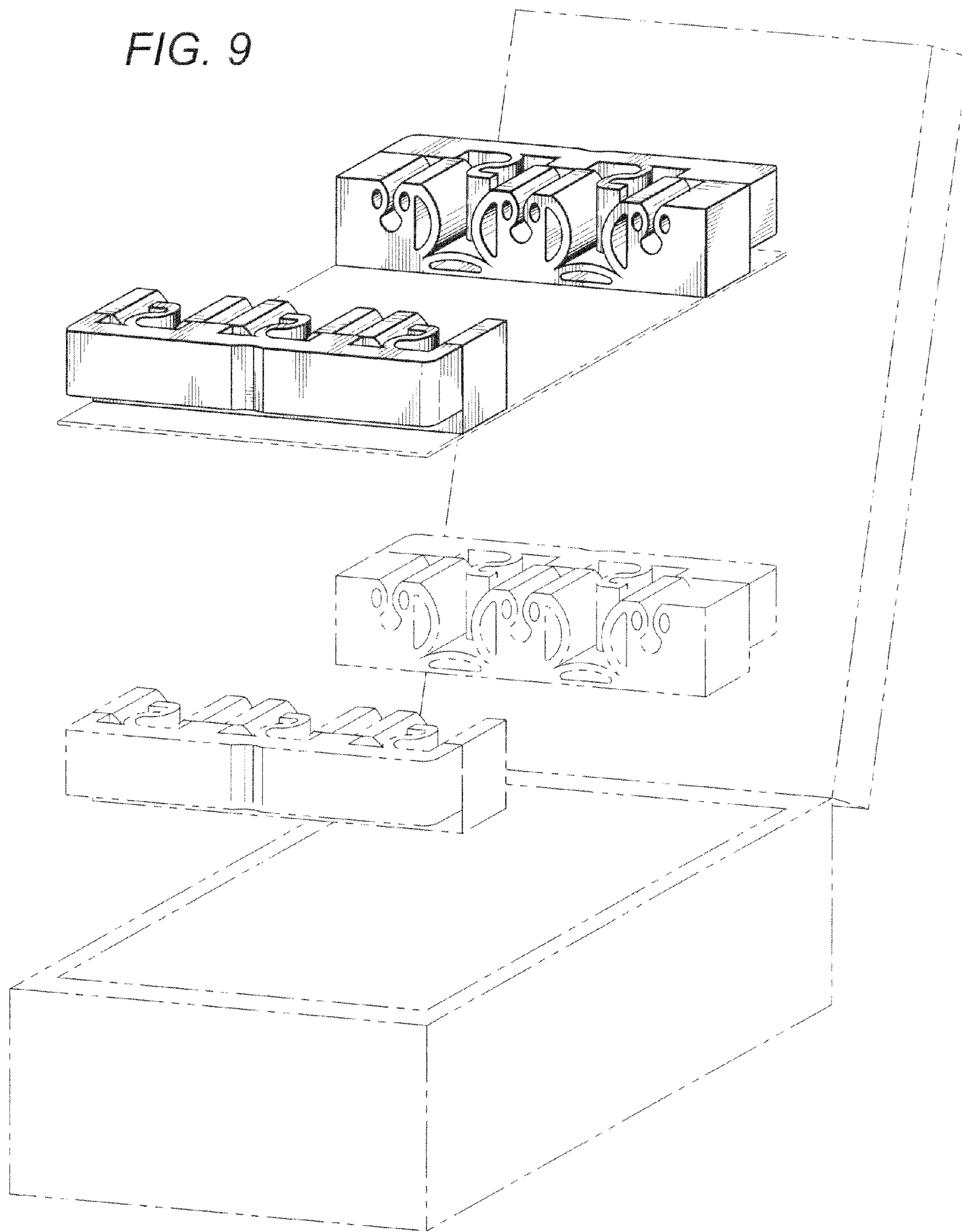

FIG. 8



FIG. 9



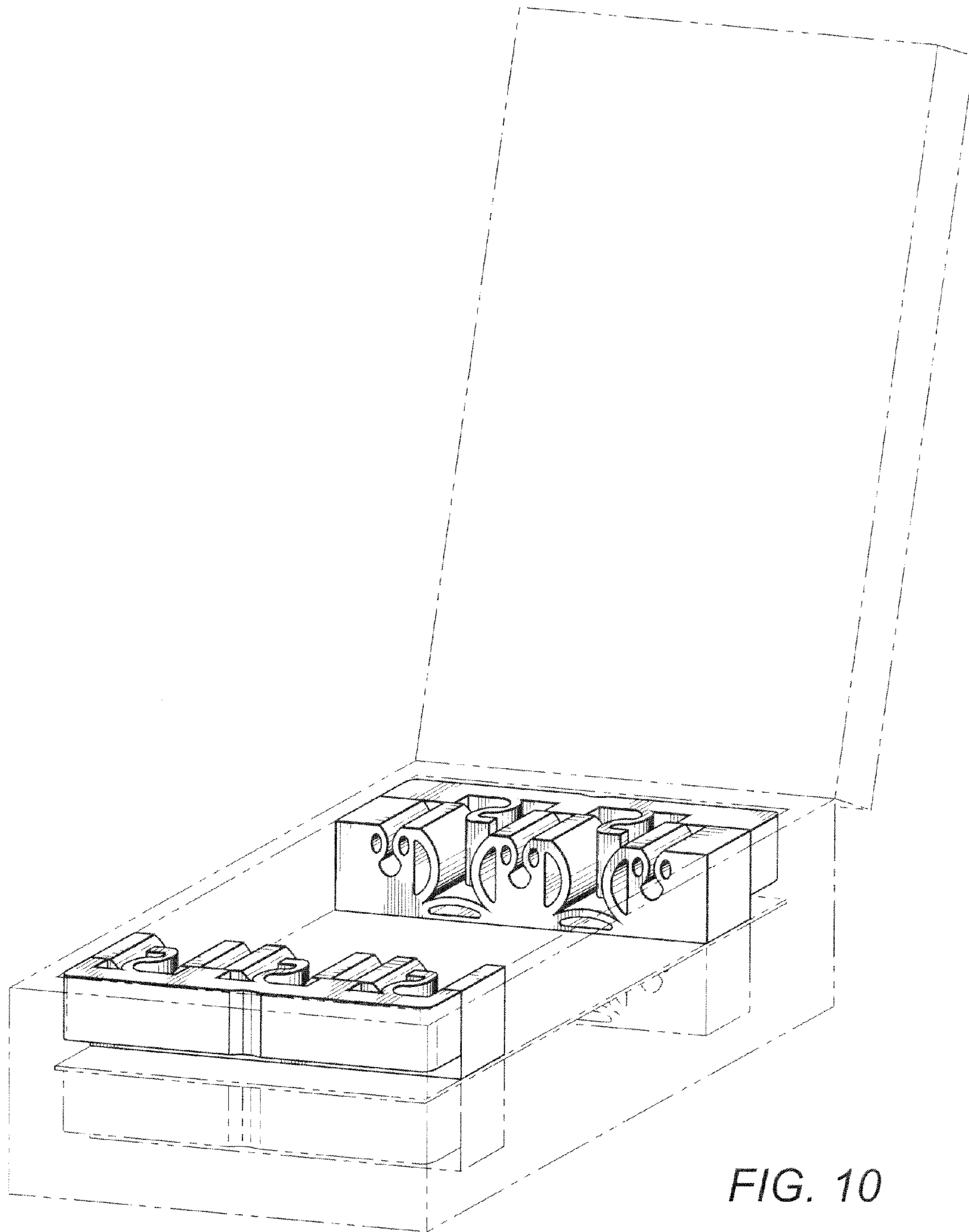

FIG. 10