



US00D629629S

(12) **United States Design Patent**  
**Swy**

(10) **Patent No.:** **US D629,629 S**  
(45) **Date of Patent:** **\*\* Dec. 28, 2010**

(54) **CHAIR**

(75) Inventor: **Philip P. Swy**, Temperance, MI (US)

(73) Assignee: **Michigan Tube Swagers & Fabricators, Inc.**, Temperance, MI (US)

(\*\*) Term: **14 Years**

(21) Appl. No.: **29/365,846**

(22) Filed: **Jul. 15, 2010**

**Related U.S. Application Data**

(62) Division of application No. 29/326,504, filed on Oct. 20, 2008, now Pat. No. Des. 624,327.

(51) **LOC (9) Cl.** ..... **06-01**

(52) **U.S. Cl.** ..... **D6/374**

(58) **Field of Classification Search** ..... D6/334-336,  
D6/371, 372, 373, 374, 375, 376, 379, 380,  
D6/500-502; 297/183.1, 183.7, 239, 445.1,  
297/446.1, 448.1, 452.38, 452.48

See application file for complete search history.

(56) **References Cited**

**U.S. PATENT DOCUMENTS**

3,203,731	A *	8/1965	Krueger	297/239
3,856,352	A	12/1974	Jacobi, Sr.	
5,524,963	A *	6/1996	Barile	297/239
7,052,083	B2	5/2006	Peitz et al.	
D602,278	S	10/2009	Kubryk	

(Continued)

**OTHER PUBLICATIONS**

Printout from SKS Australia website: [www.sksaustralia.com.au/chairs.html](http://www.sksaustralia.com.au/chairs.html), dated Jul. 13, 2010 (believed to have been offered for sale, publicly used, and/or published prior to the filing date of this application).

MTS Alpha/Omega Steel Series, Model #577 (believed to have been offered for sale, publicly used, and/or published prior to the filing date of this application).

(Continued)

*Primary Examiner*—Mimosa De

(74) *Attorney, Agent, or Firm*—Gifford, Krass, Sprinkle, Anderson & Citkowski, P.C.

(57) **CLAIM**

The ornamental design for a chair, as shown and described.

**DESCRIPTION**

FIG. 1 is a perspective view of a chair according to a first embodiment of the present invention;

FIG. 2 is a side elevational view of the chair of FIG. 1, the opposite side being a mirror image thereof;

FIG. 3 is a front elevational view of the chair of FIGS. 1 and 2;

FIG. 4 is a rear elevational view of the chair of FIGS. 1-3;

FIG. 5 is a top view of the chair of FIGS. 1-4;

FIG. 6 is a bottom view of the chair of FIGS. 1-5;

FIG. 7 is a perspective view of an alternative version of the chair of FIG. 1;

FIG. 8 is a side elevational view of the chair of FIG. 7, the opposite side being a mirror image thereof;

FIG. 9 is a front elevational view of the chair of FIGS. 7 and 8;

FIG. 10 is a rear elevational view of the chair of FIGS. 7-9;

FIG. 11 is a top view of the chair of FIGS. 7-10; and,

FIG. 12 is a bottom view of the chair of FIGS. 7-11.

The broken line showing of the footrests are for illustrative purposes only and form no part of the claimed design.

**1 Claim, 6 Drawing Sheets**

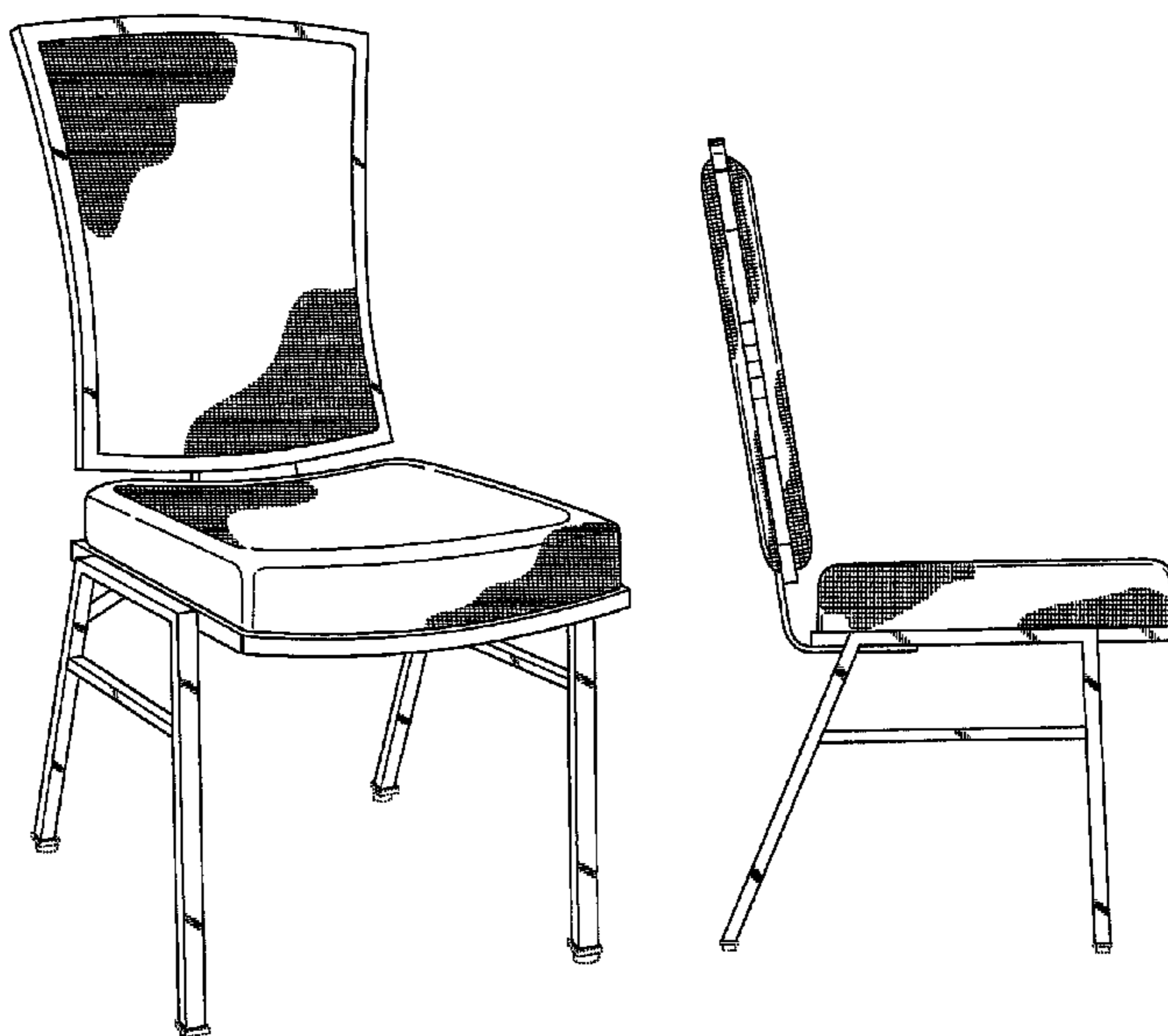

U.S. PATENT DOCUMENTS

D602,279	S	10/2009	Kubryk	
D603,179	S *	11/2009	Kubryk	..... D6/374
D607,226	S	1/2010	Kubryk	
D607,655	S	1/2010	Kubryk	
D607,657	S	1/2010	Kubryk	
D607,659	S	1/2010	Kubryk	
D608,105	S *	1/2010	Kubryk	..... D6/380
D611,266	S *	3/2010	Kubryk	..... D6/374
D624,327	S *	9/2010	Swy	..... D6/374
2005/0242651	A1 *	11/2005	Peitz et al.	..... 297/452.38

OTHER PUBLICATIONS

MTS Alpha/Omega Steel Series, Model #578 (believed to have been offered for sale, publicly used, and/or published prior to the filing date of this application).

Shelby Williams, the Premier Banquet Series, p. BQ-50 (believed to have been offered for sale, publicly used, and/or published prior to the filing date of this application).

Tri-Par, Square Tubular Steel Stacking Chairs, p. 8 (believed to have been offered for sale, publicly used, and/or published prior to the filing date of this application).

SKS, Tajam Banquet Chair (believed to have been offered for sale, publicly used, and/or published prior to the filing date of this application).

Global Allies, Richmond Stacking Chair (believed to have been offered for sale, publicly used, and/or published prior to the filing date of this application).

Global Allies, Oz Stacking Chair with Tapered Legs, 2008 (believed to have been offered for sale, publicly used, and/or published prior to the filing date of this application).

\* cited by examiner

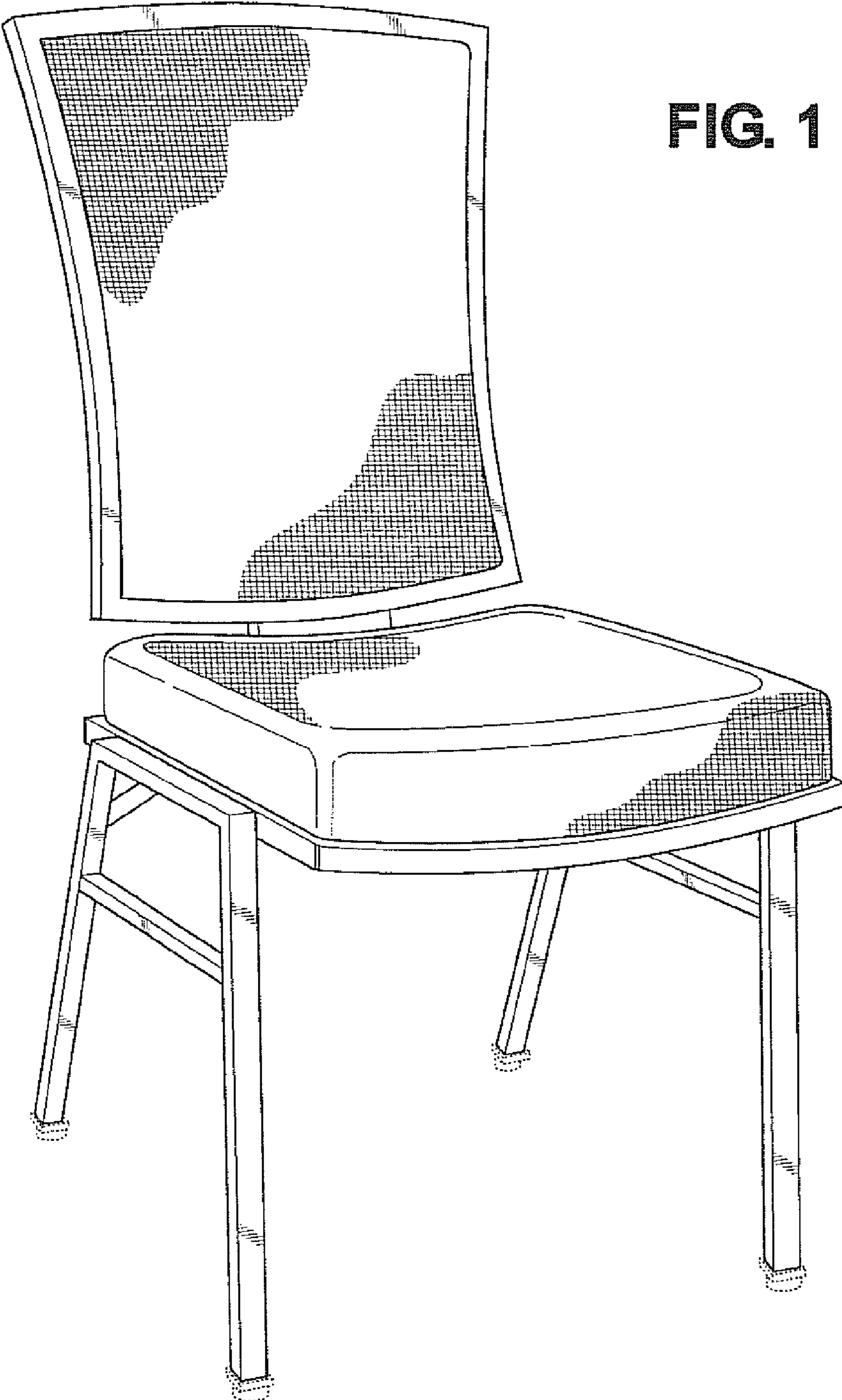

FIG. 1

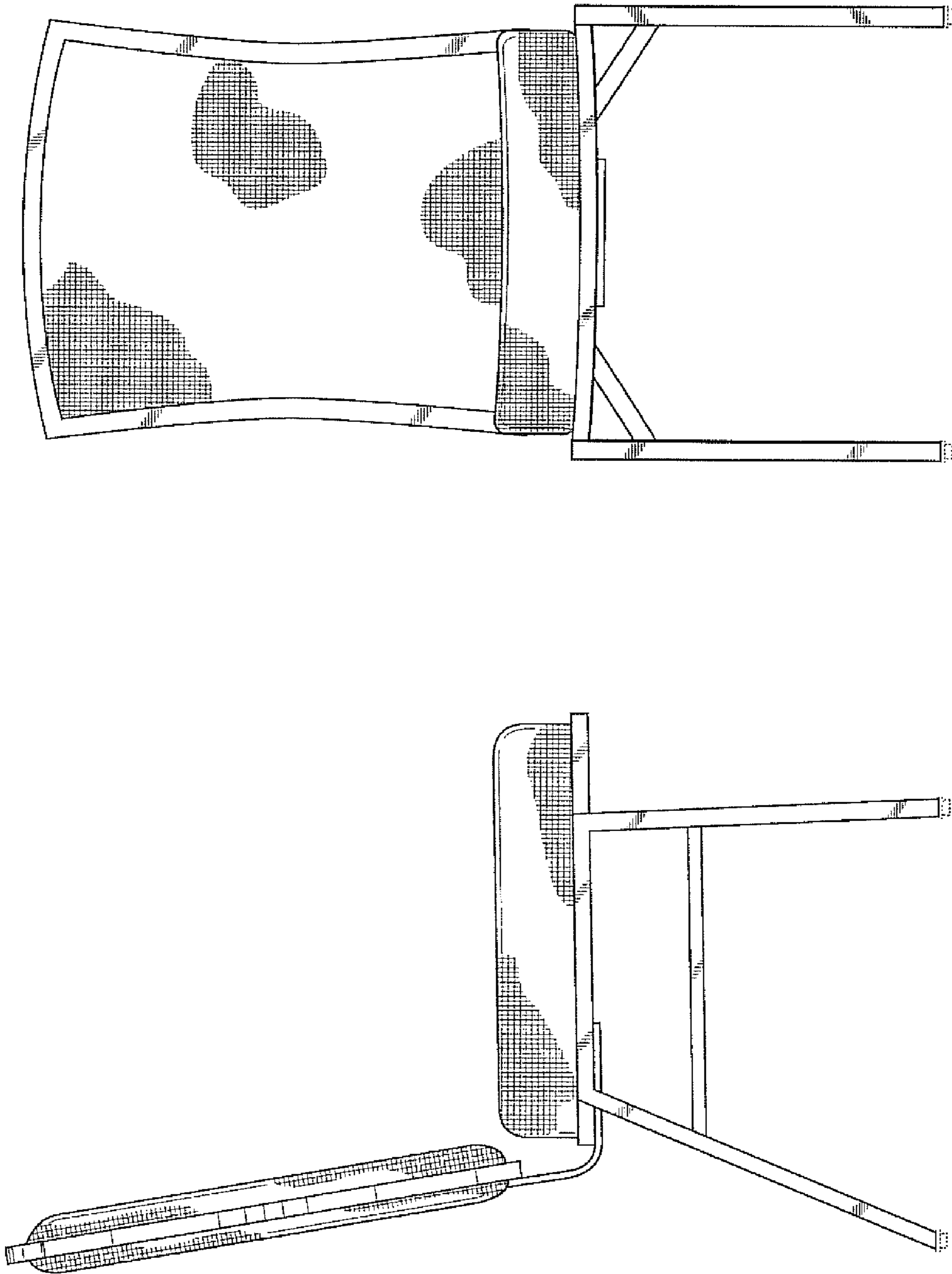

FIG. 2

FIG. 3



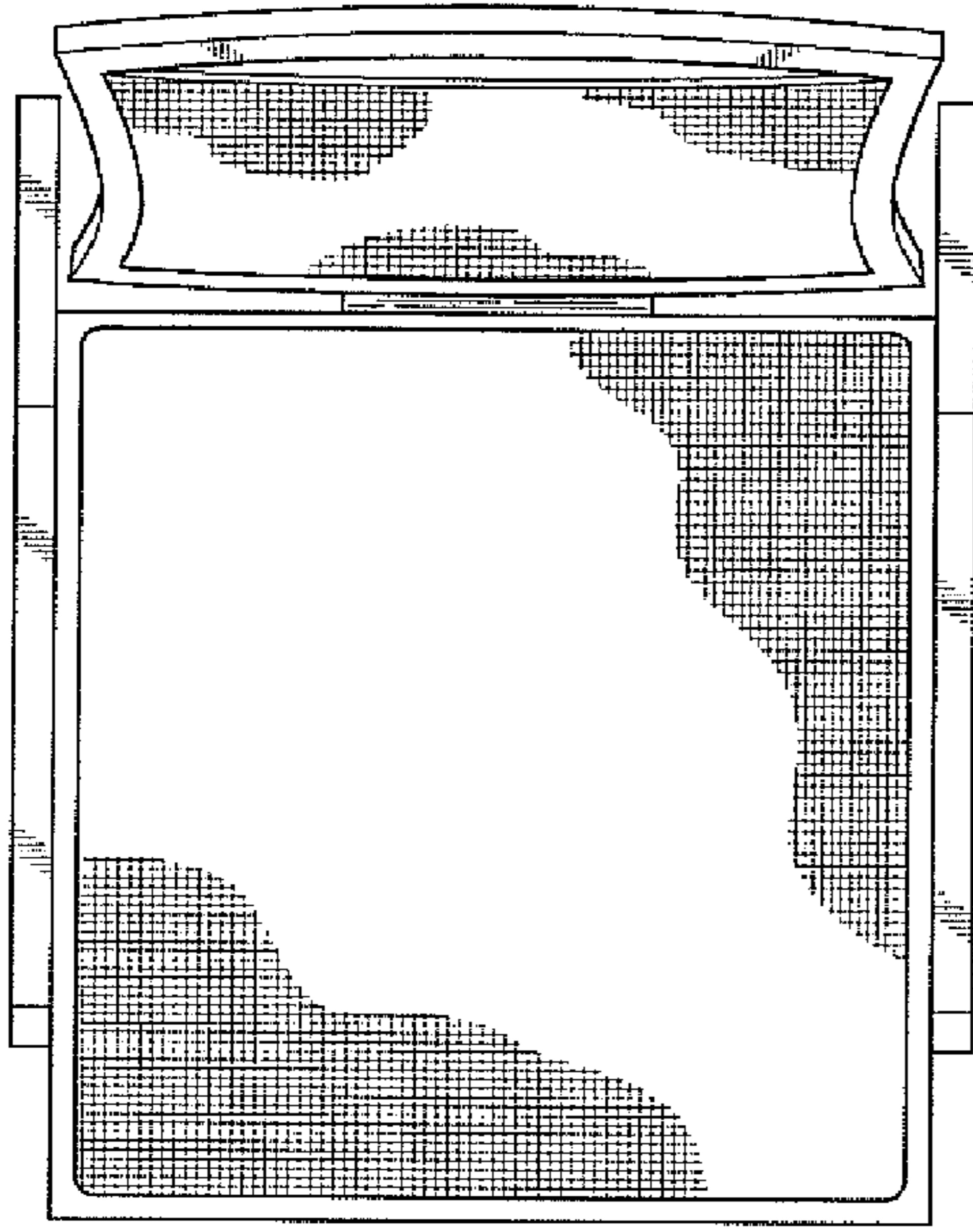

FIG. 5

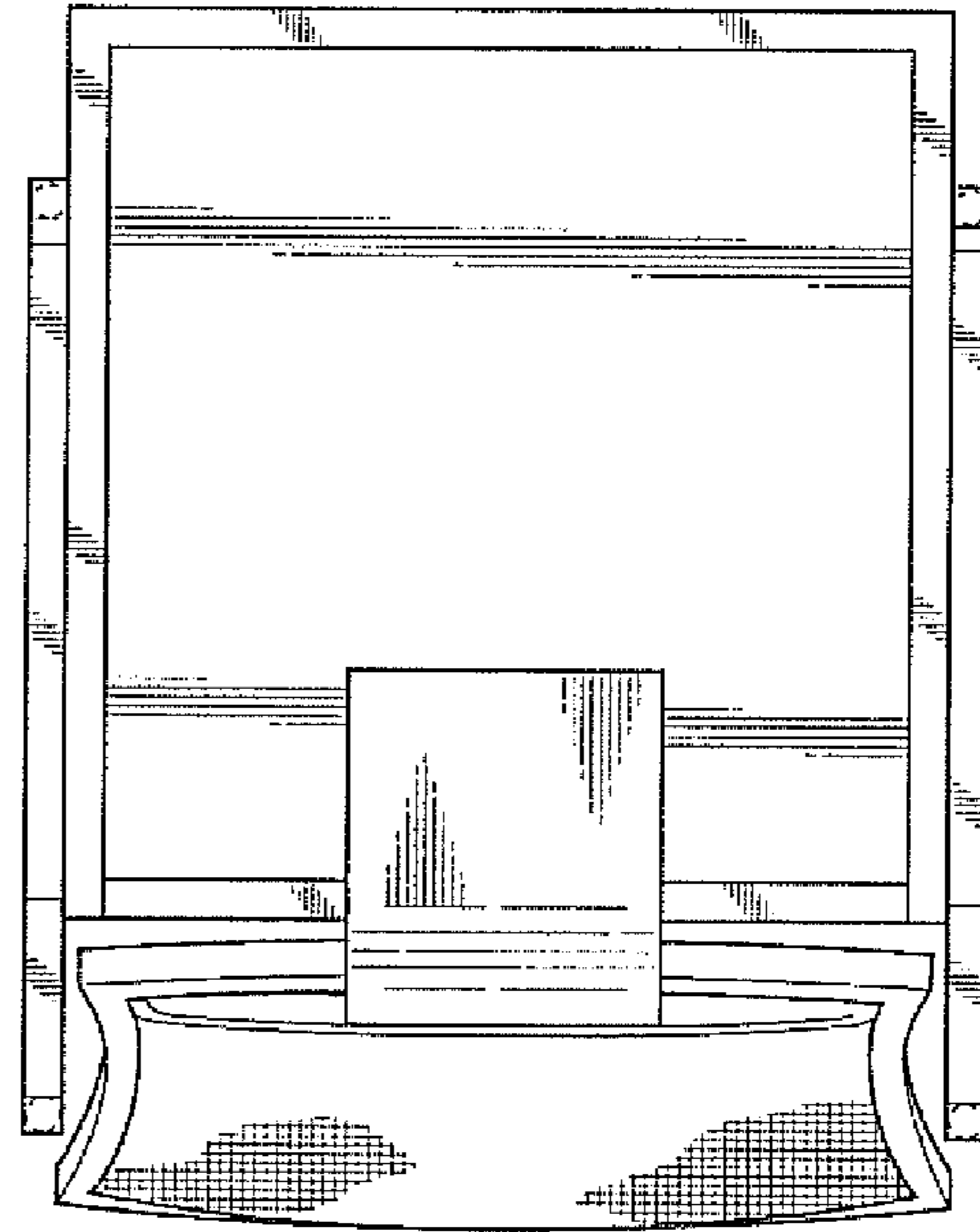

FIG. 6

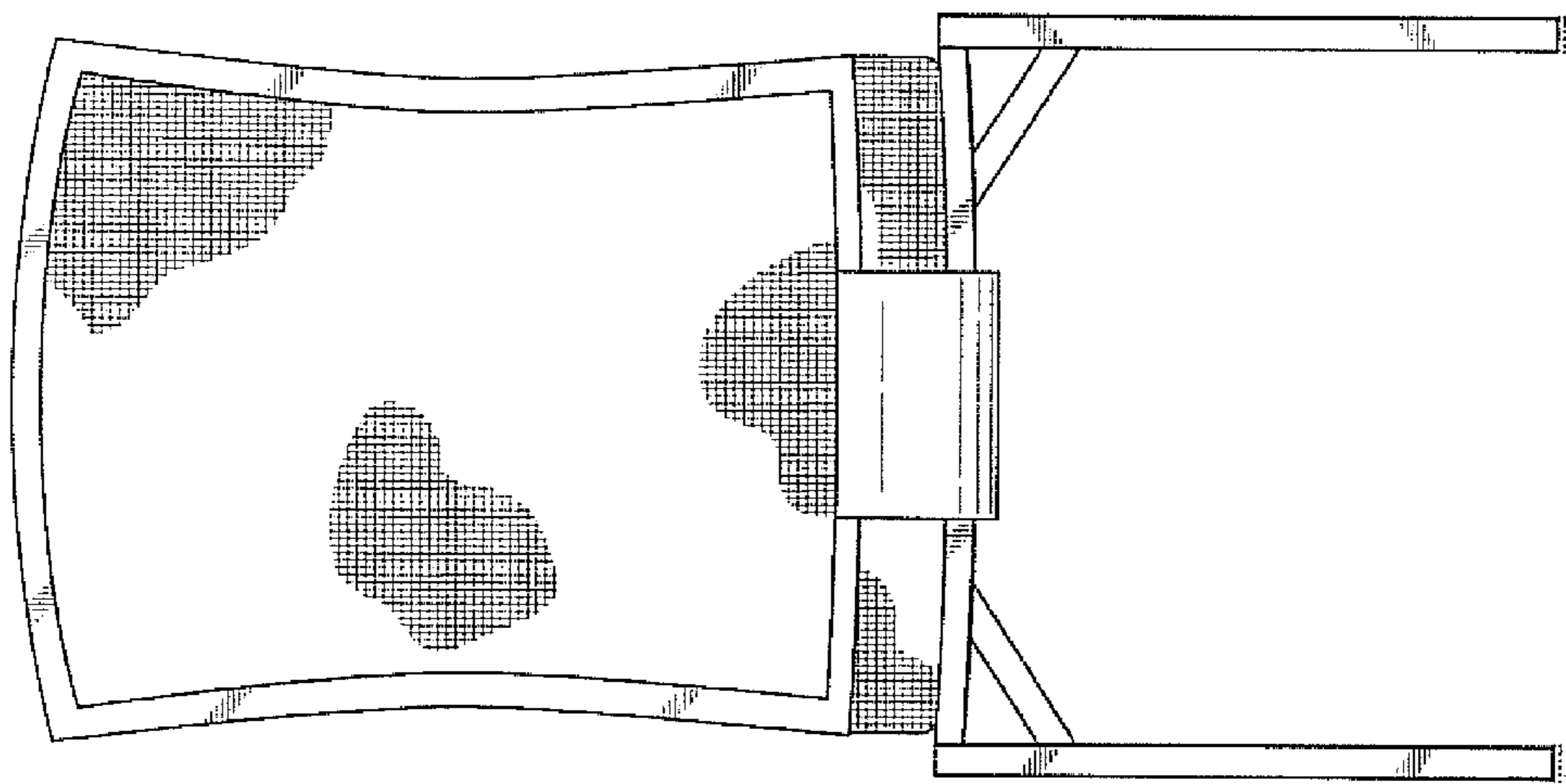
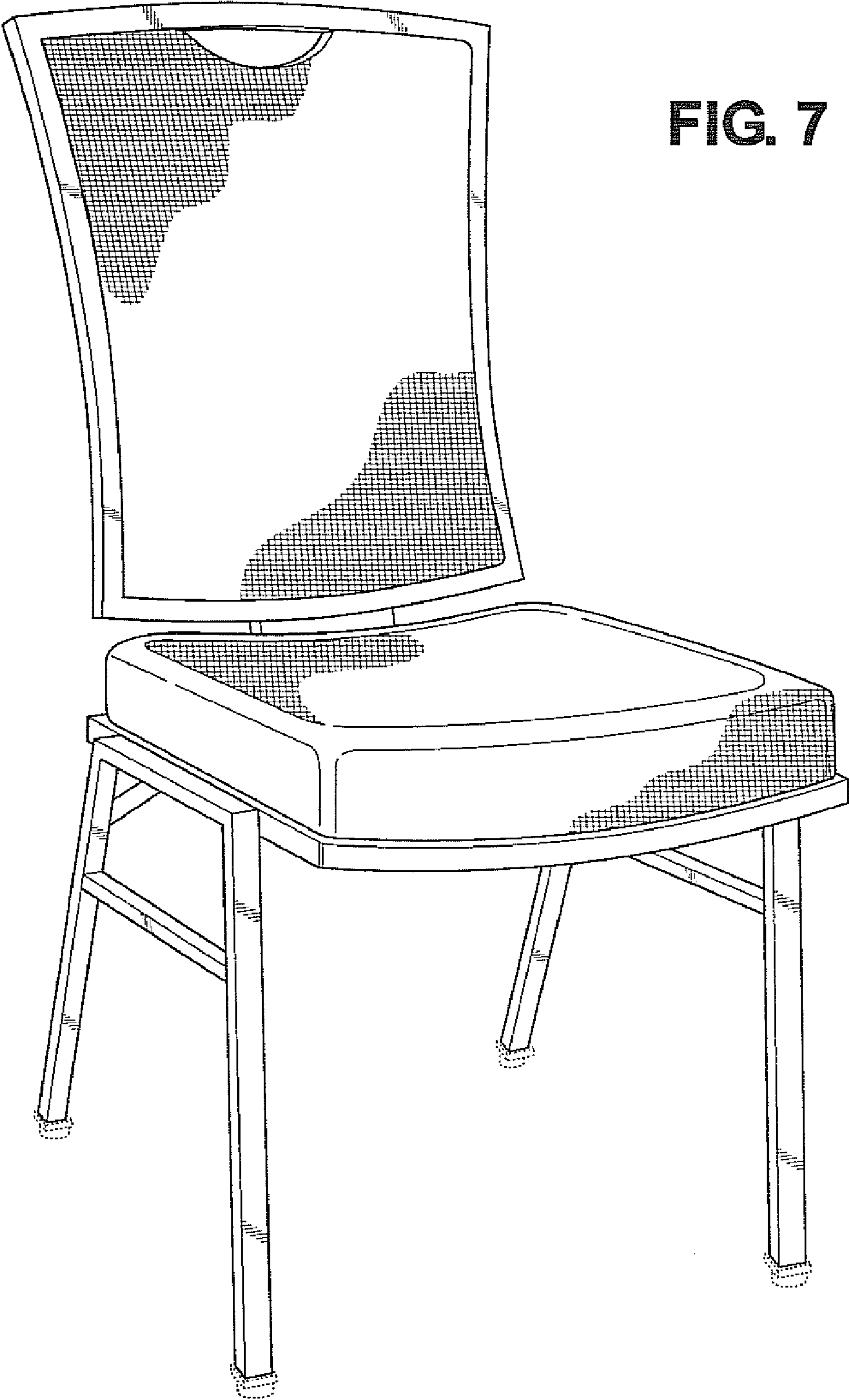

FIG. 4



**FIG. 7**

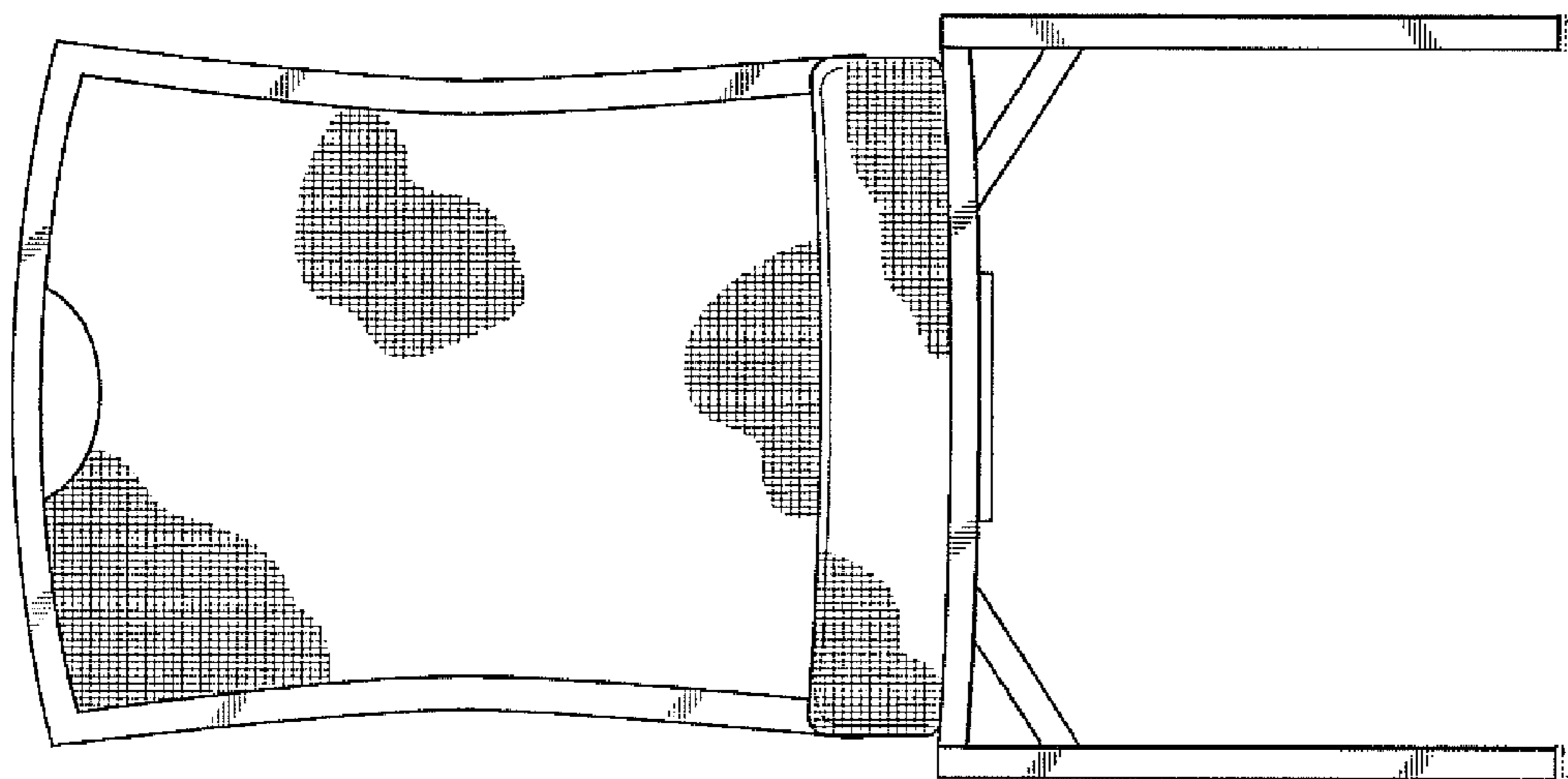

FIG. 9

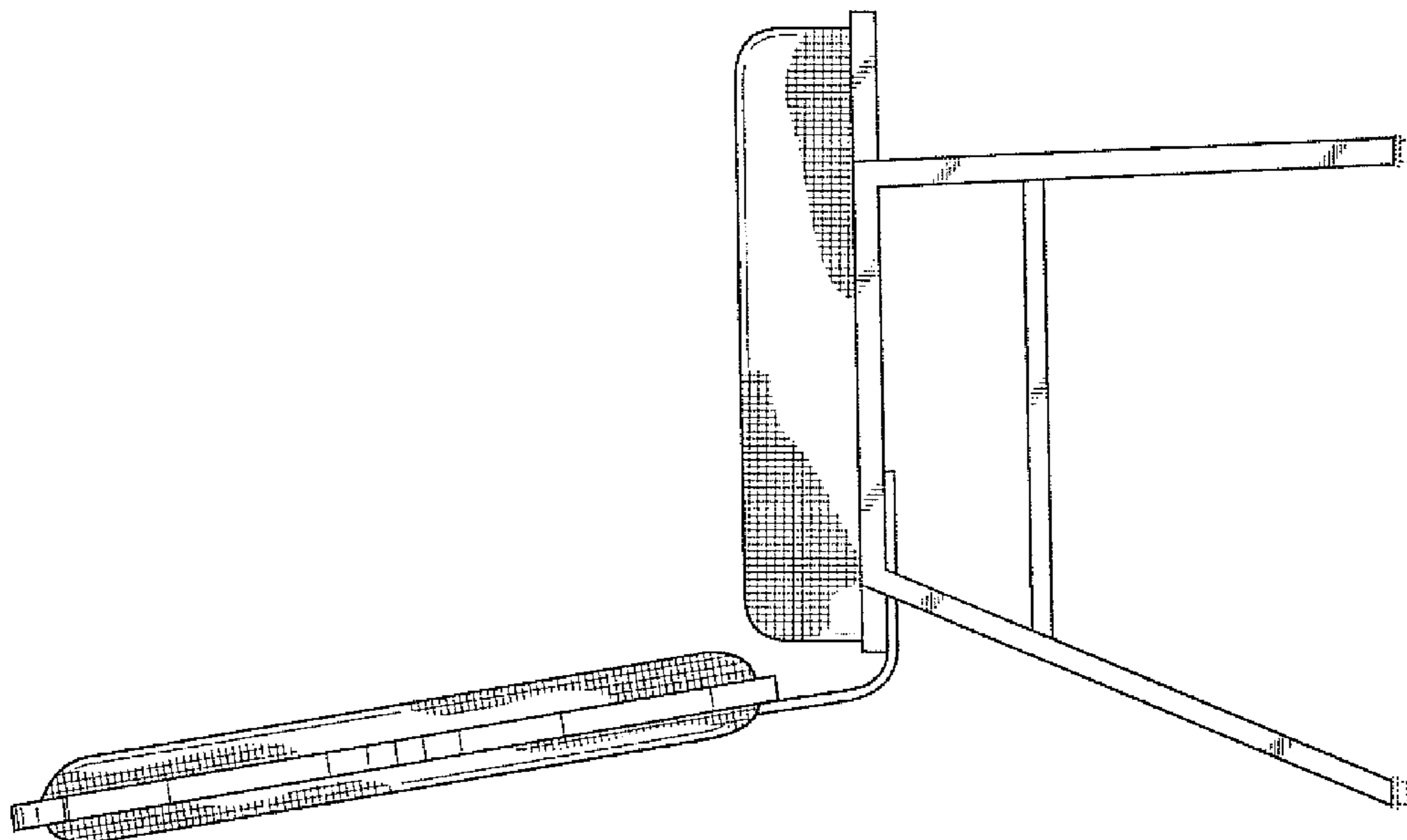

FIG. 8

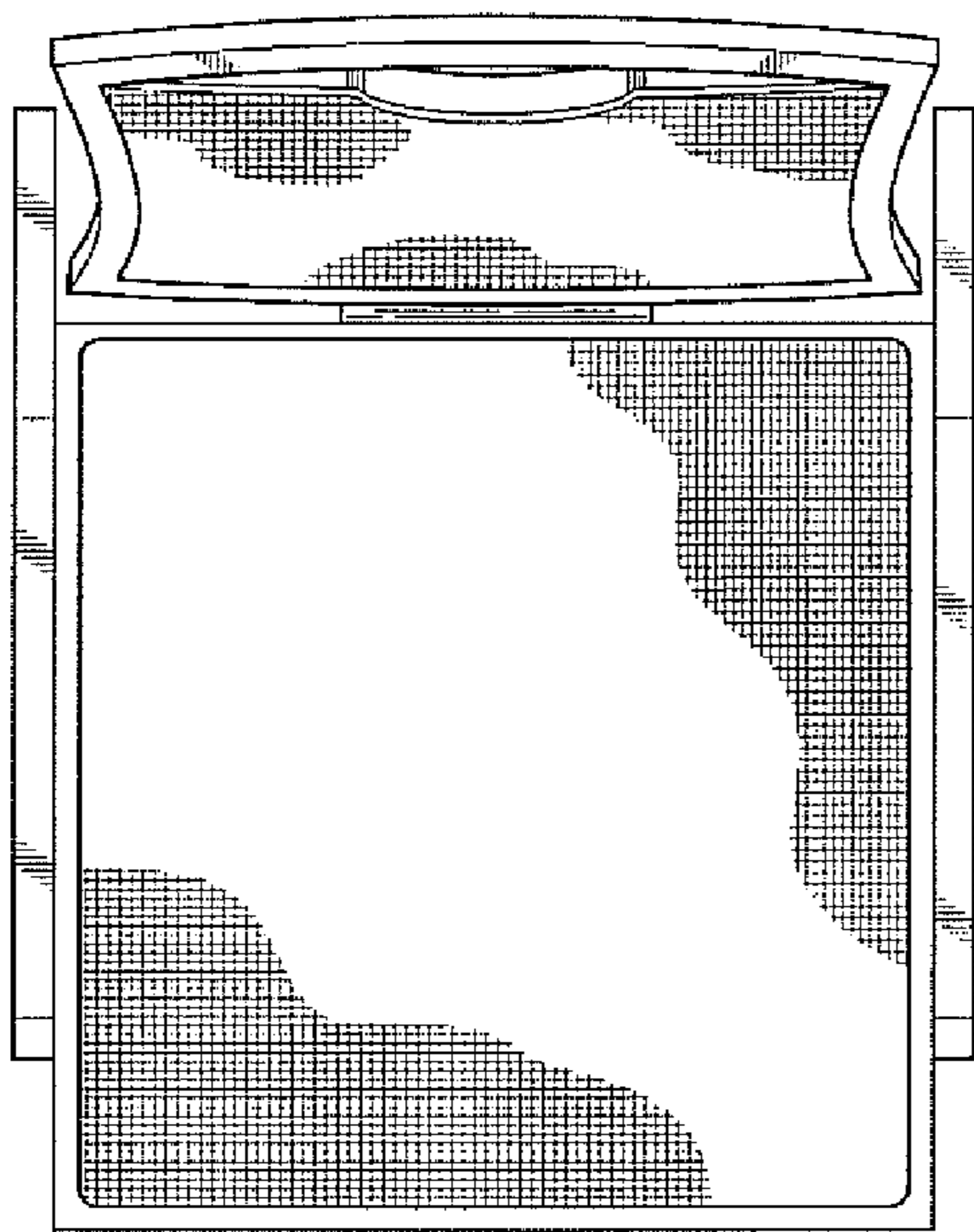

FIG. 11

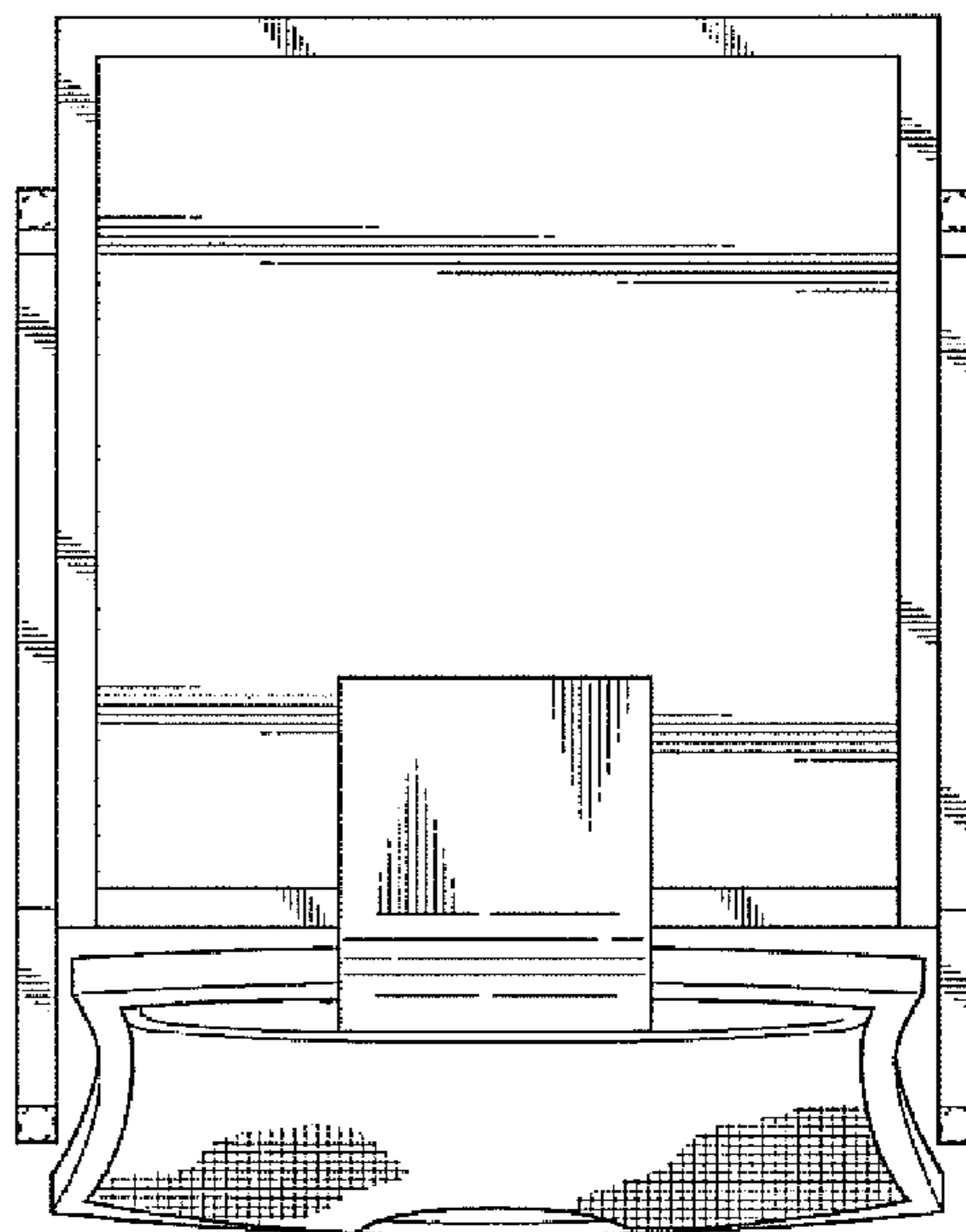

FIG. 12

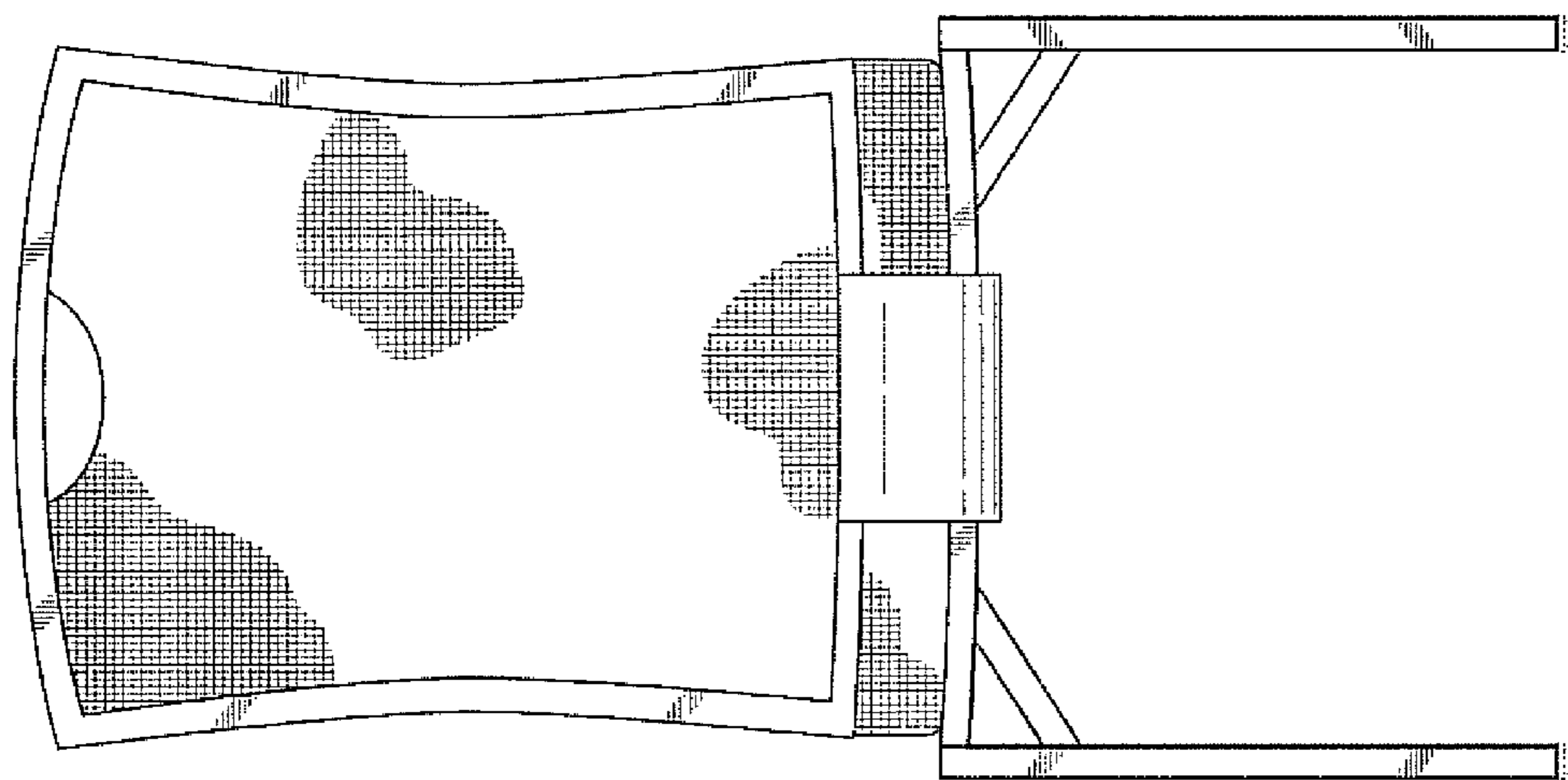

FIG. 10