



US00D629606S

(12) **United States Design Patent**  
**Guichot**

(10) **Patent No.:** **US D629,606 S**  
(45) **Date of Patent:** **\*\* Dec. 28, 2010**

(54) **HANDBAG**

(75) Inventor: **Isabelle Guichot**, Paris (FR)

(73) Assignee: **Balenciaga**, Paris (FR)

(\*\*) Term: **14 Years**

(21) Appl. No.: **29/363,743**

(22) Filed: **Jun. 14, 2010**

(51) **LOC (9) Cl.** ..... **03-01**

(52) **U.S. Cl.** ..... **D3/243**

(58) **Field of Classification Search** ..... D3/232–233,  
D3/240–246, 318, 324; 150/100, 103–110,  
150/113–114, 118–119

See application file for complete search history.

(56) **References Cited**

**U.S. PATENT DOCUMENTS**

D572,469 S \* 7/2008 Morelli ..... D3/232

D578,754 S \* 10/2008 Sassi ..... D3/246

D584,044 S \* 1/2009 Morelli ..... D3/232

D594,651 S \* 6/2009 Fendi ..... D3/243

\* cited by examiner

*Primary Examiner*—Holly H Baynham

(74) *Attorney, Agent, or Firm*—Collen IP; Donald J. Ranft

(57) **CLAIM**

The ornamental design for a handbag, as shown and described.

**DESCRIPTION**

FIG. 1 is a front view of my new, original and ornamental design for a handbag;

FIG. 2 is a rear view thereof;

FIG. 3 is a top view thereof;

FIG. 4 is a bottom view thereof;

FIG. 5 is a left side view thereof;

FIG. 6 is a right side view thereof; and,

FIG. 7 is a front perspective view thereof.

The broken lines showing stitching are part of the claimed design.

**1 Claim, 7 Drawing Sheets**



FIG. 1

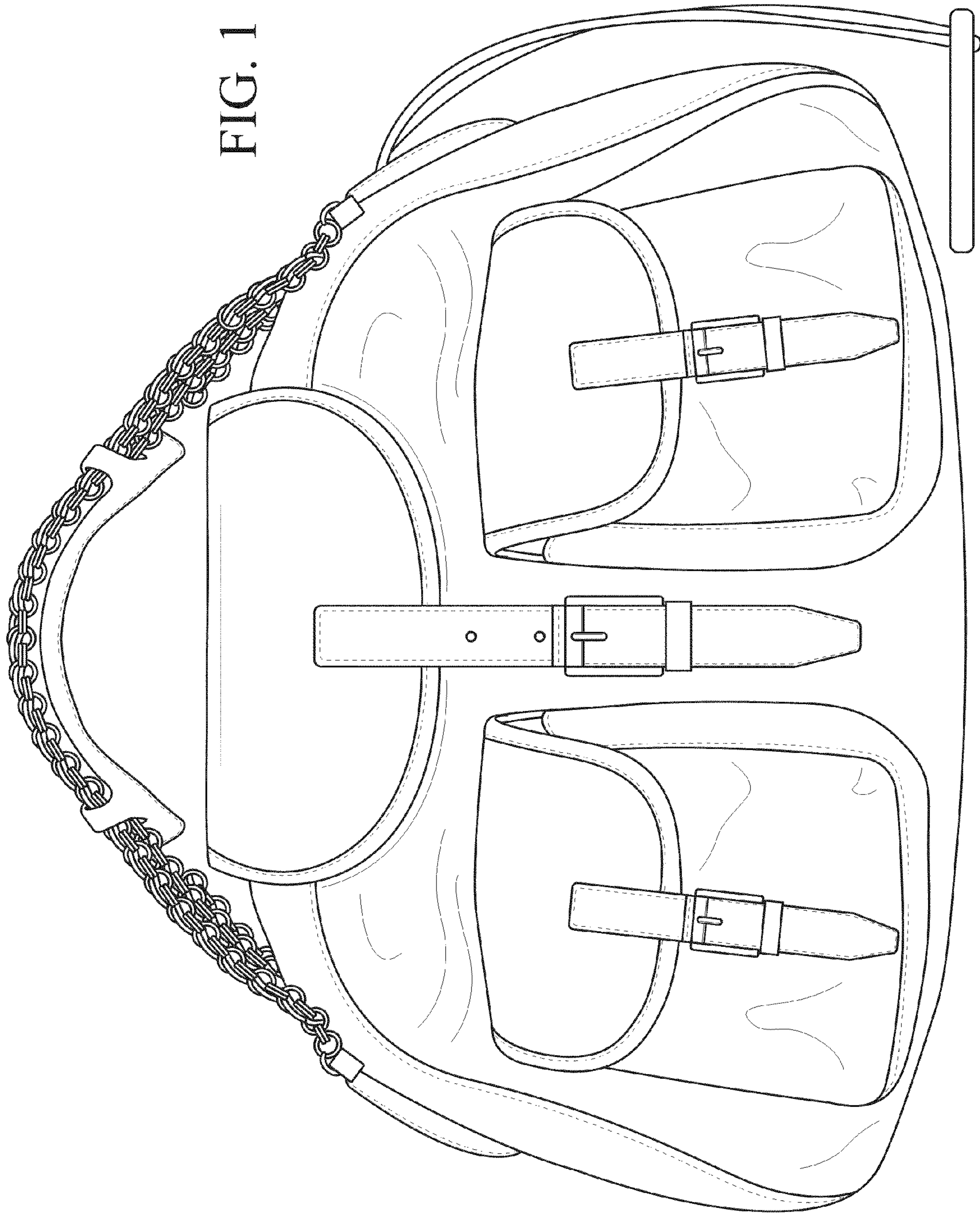
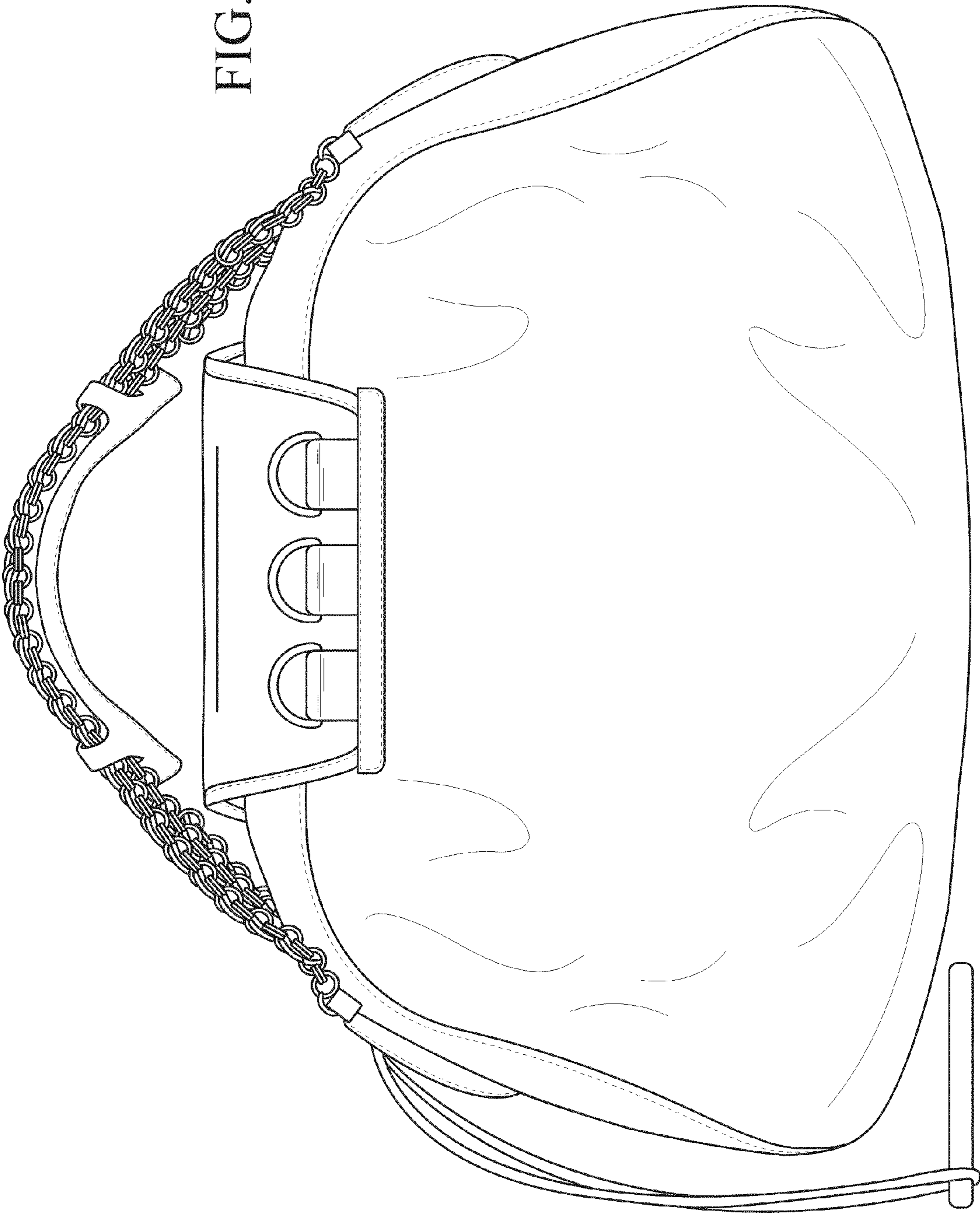



FIG. 2



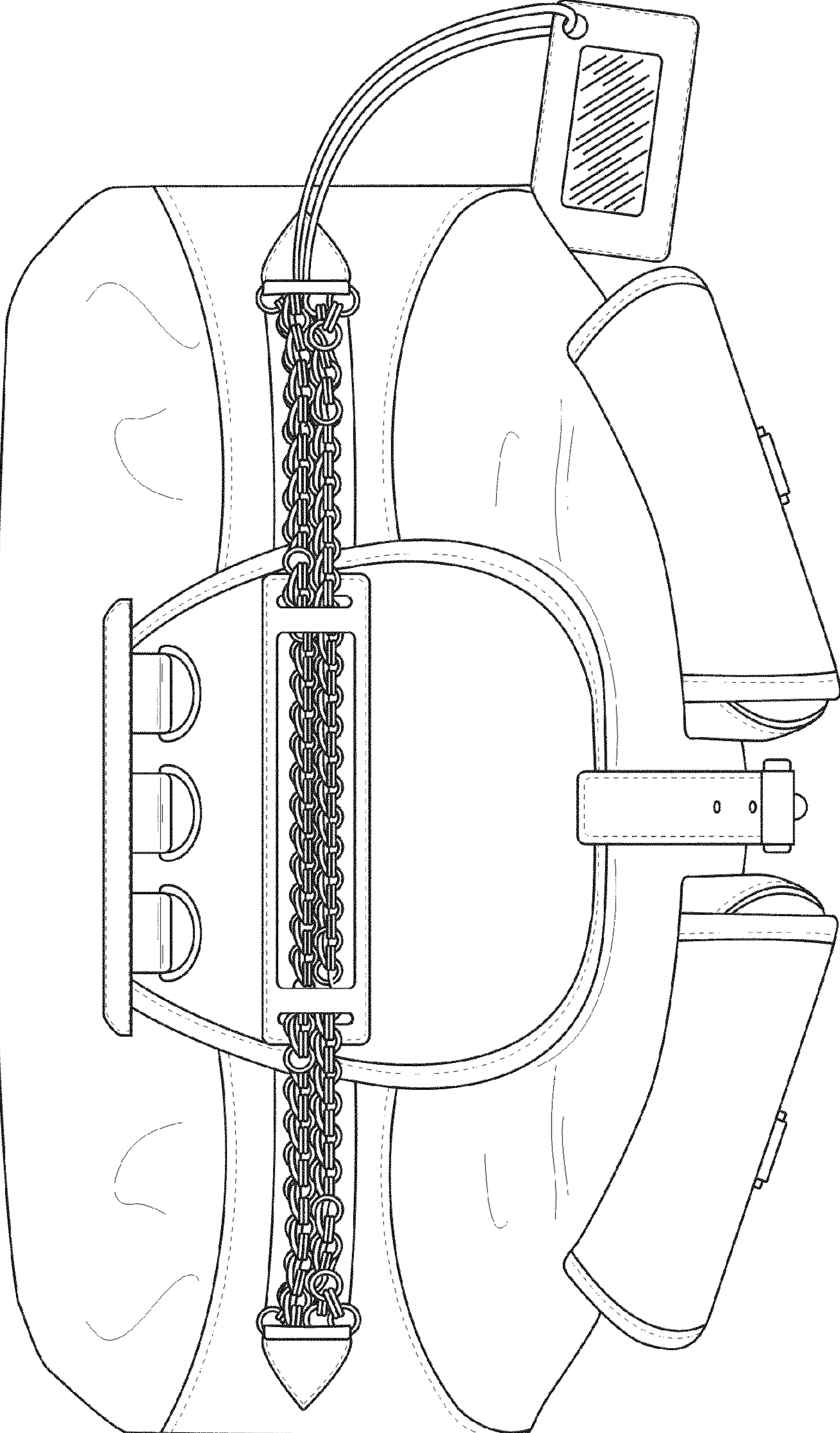

FIG. 3

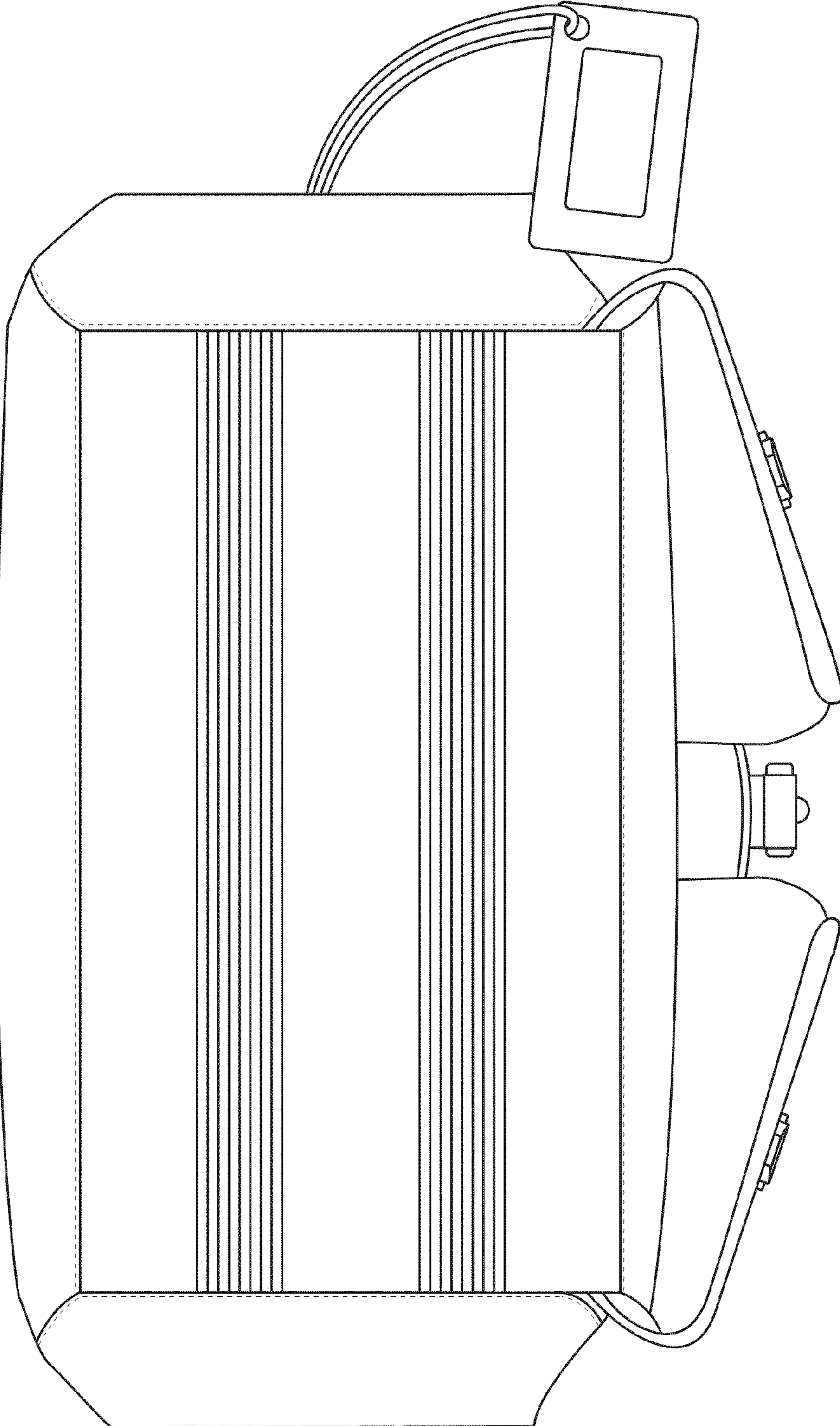

FIG. 4



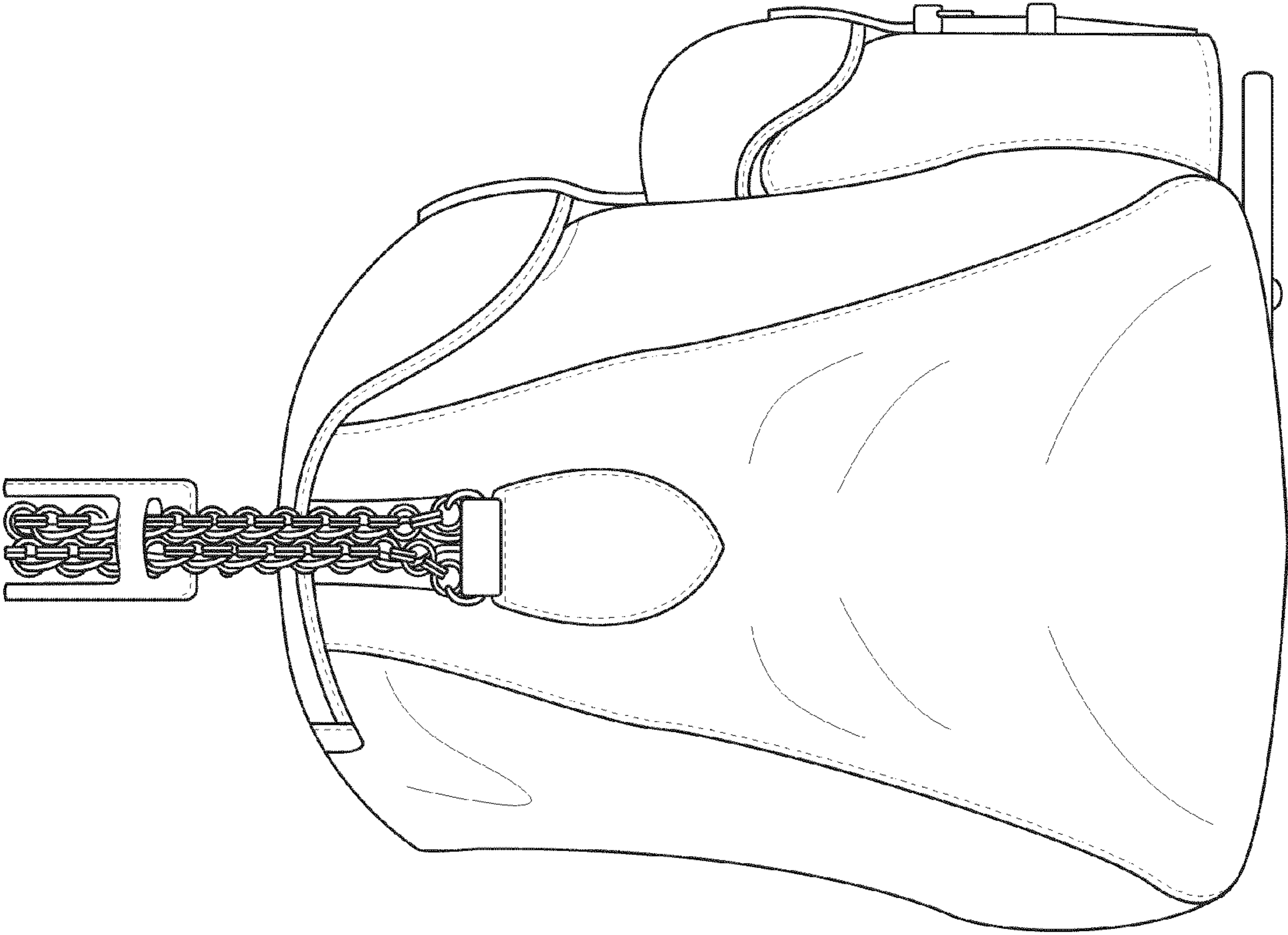

FIG. 5

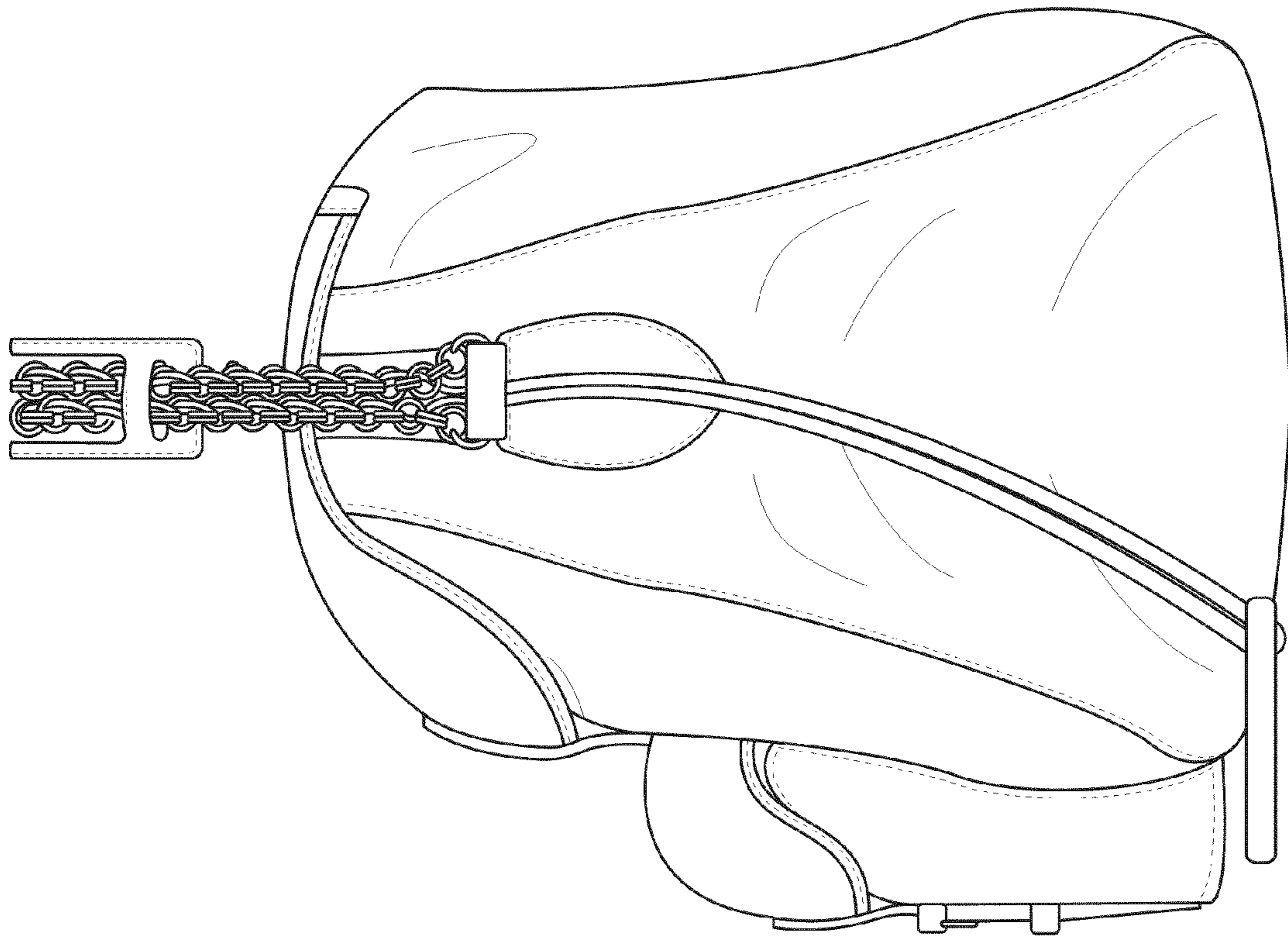

FIG. 6

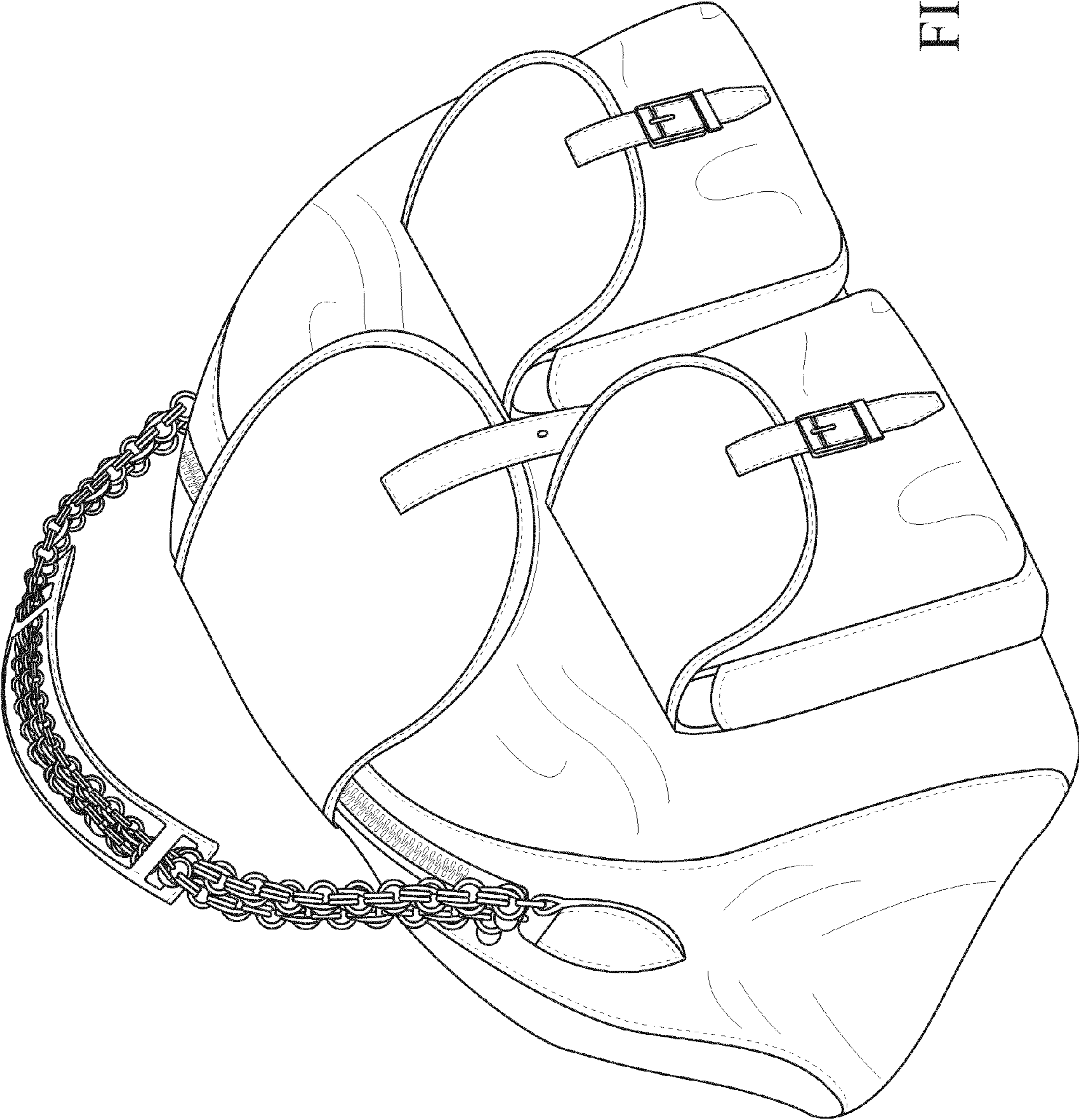

FIG. 7