



US00D629520S

(12) **United States Design Patent**
Horton

(10) **Patent No.:** **US D629,520 S**

(45) **Date of Patent:** **** Dec. 21, 2010**

(54) **SPINOUS PROCESS IMPLANT**

6,520,907 B1 2/2003 Foley et al.
6,540,747 B1 4/2003 Marino

(76) Inventor: **Kenneth L. Horton**, 174 Oxmoor Rd.,
Birmingham, AL (US) 35209

(Continued)

(**) Term: **14 Years**

FOREIGN PATENT DOCUMENTS

(21) Appl. No.: **29/357,852**

WO 2000/022998 A1 4/2000

(22) Filed: **Mar. 18, 2010**

(Continued)

(51) **LOC (9) Cl.** **24-03**

(52) **U.S. Cl.** **D24/155**

(58) **Field of Classification Search** D24/155-157;
606/60, 61, 73, 95, 213, 246, 248, 249; 623/23.61,
623/23.56, 247, 213, 11.11, 16.14, 20.23,
623/20.33, 33, 41, 17.11-17.16; D21/460;
D8/382

OTHER PUBLICATIONS

Mathews, "Percutaneous Interbody Fusions", Orthopedic Clinics of
North America, Oct. 1, 1998, pp. 647-653, vol. 29, Issue 4, published
by Elsevier, Inc.

(Continued)

See application file for complete search history.

Primary Examiner—Charles A Rademaker
(74) *Attorney, Agent, or Firm*—Kenneth M. Bush; Gerald M.
Walsh; Bush Intellectual Property Law

(56) **References Cited**

(57) **CLAIM**

U.S. PATENT DOCUMENTS

I claim the ornamental design for a spinous process implant,
as shown and described.

- D181,779 S * 12/1957 Buralli D21/460
- D274,359 S * 6/1984 Christensen et al. D24/155
- 4,501,269 A 2/1985 Bagby
- D283,301 S * 4/1986 Spitz D8/382
- 4,581,962 A 4/1986 Marbourg
- 5,015,247 A 5/1991 Michelson
- 5,171,278 A * 12/1992 Pisharodi 623/17.16
- 5,306,307 A 4/1994 Senter et al.
- 5,458,638 A * 10/1995 Kuslich et al. 623/17.11
- 5,484,437 A 1/1996 Michelson
- 5,489,307 A 2/1996 Kuslich et al.
- 5,593,409 A 1/1997 Michelson
- D378,314 S * 3/1997 Koros et al. D24/155
- 5,741,253 A 4/1998 Michelson
- 5,741,261 A 4/1998 Moskovitz et al.
- 5,860,973 A 1/1999 Michelson
- 5,954,635 A 9/1999 Foley et al.
- D416,189 S * 11/1999 Bollman D8/382
- 6,042,582 A 3/2000 Ray
- 6,080,155 A 6/2000 Michelson
- 6,210,412 B1 4/2001 Michelson
- 6,371,988 B1 4/2002 Pafford et al.
- 6,391,058 B1 * 5/2002 Kuslich et al. 623/17.11
- 6,485,518 B1 11/2002 Cornwall et al.

DESCRIPTION

FIG. 1 is a rear perspective view of my spinous process
implant showing my new design;
FIG. 2 is a rear elevation view thereof;
FIG. 3 is a front elevation view thereof;
FIG. 4 is a left side elevation view thereof;
FIG. 5 is a right side elevation view thereof;
FIG. 6 is a front perspective view thereof;
FIG. 7 is a rear perspective view of an alternate embodiment
of my spinous process implant;
FIG. 8 is a rear elevation view thereof;
FIG. 9 is a front elevation view thereof;
FIG. 10 is a left side elevation view thereof;
FIG. 11 is a right side elevation view thereof; and,
FIG. 12 is a front perspective view thereof.
A surgical implant used to fuse spinal vertebrae.

1 Claim, 8 Drawing Sheets

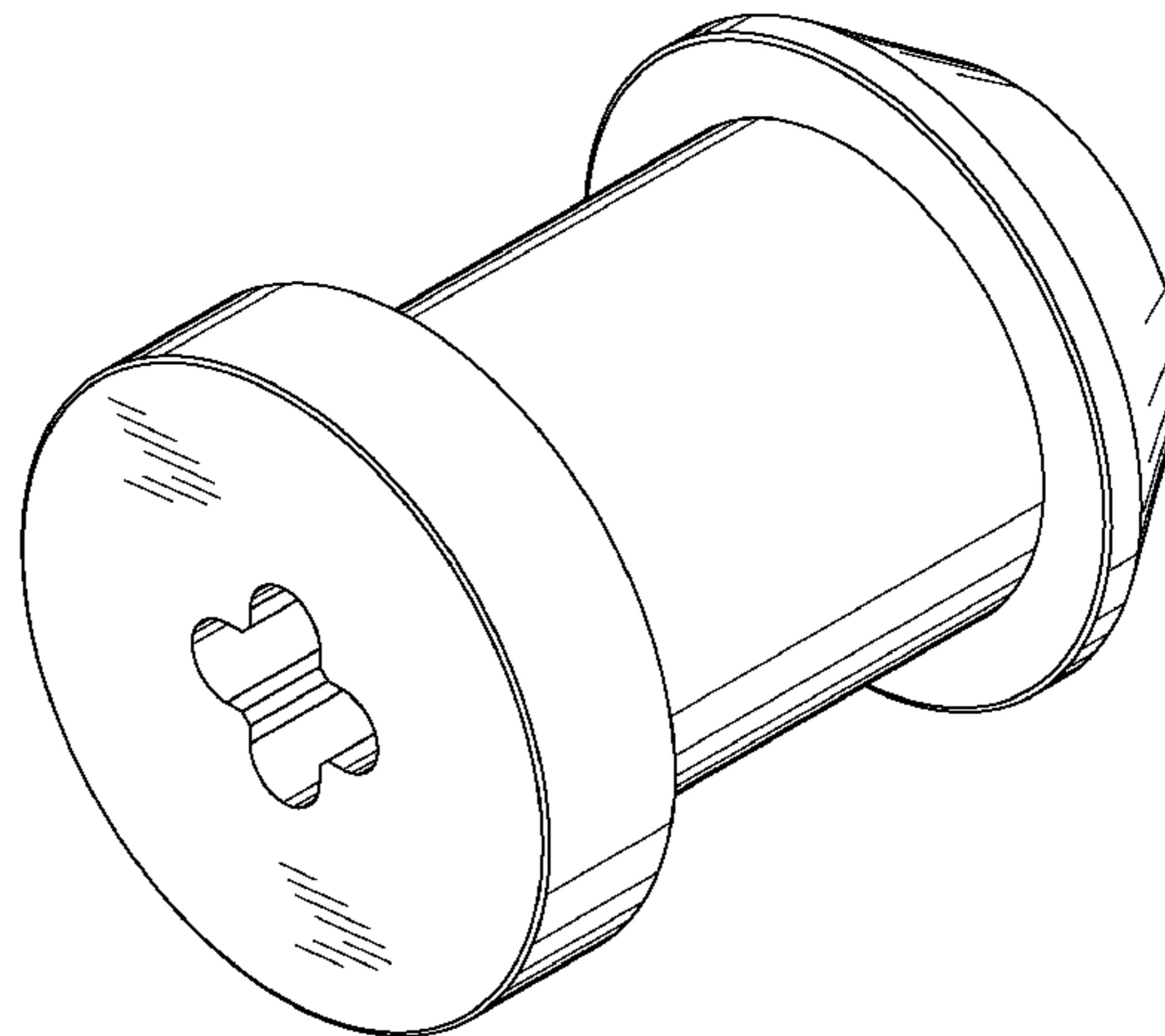
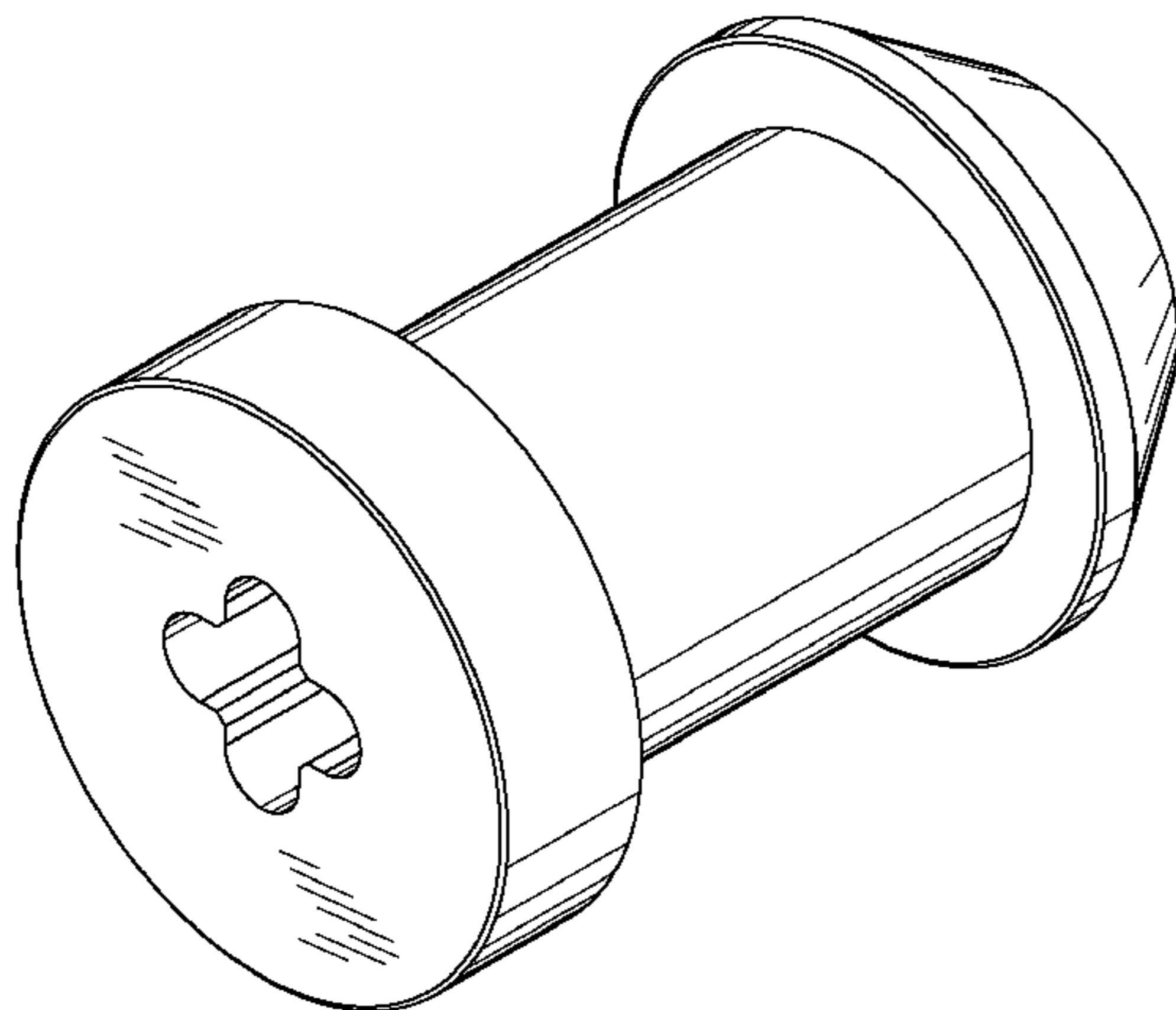

US D629,520 S

Page 2

U.S. PATENT DOCUMENTS

6,562,046 B2 5/2003 Sasso
6,579,319 B2 6/2003 Goble et al.
6,902,578 B1 6/2005 Anderson et al.
6,905,512 B2* 6/2005 Paes et al. 623/17.11
6,923,810 B1 8/2005 Michelson
6,923,811 B1 8/2005 Carl et al.
6,942,698 B1 9/2005 Jackson
7,223,269 B2 5/2007 Chappuis
D563,212 S* 3/2008 Campbell D8/382
D574,495 S 8/2008 Petersen
D574,957 S 8/2008 Petersen
D581,538 S* 11/2008 Horton D24/155
7,452,369 B2 11/2008 Barry
D595,855 S* 7/2009 Petersen D24/155
D600,806 S 9/2009 Horton et al.
D601,251 S 9/2009 Horton et al.
D605,289 S 12/2009 Horton
D622,581 S* 8/2010 Caggiano D8/382
2004/0087948 A1 5/2004 Suddaby
2004/0143268 A1 7/2004 Falahee
2004/0215344 A1 10/2004 Hochschuler et al.
2005/0015150 A1 1/2005 Lee
2005/0065516 A1 3/2005 Jahng
2005/0149030 A1 7/2005 Serhan et al.

2006/0036264 A1 2/2006 Selover et al.
2006/0064099 A1 3/2006 Pavlov et al.
2006/0111779 A1 5/2006 Petersen
2006/0111782 A1 5/2006 Petersen
2007/0250166 A1 10/2007 McKay
2008/0255667 A1 10/2008 Horton
2009/0131986 A1 5/2009 Lee et al.

FOREIGN PATENT DOCUMENTS

WO 2007/120903 A2 10/2007

OTHER PUBLICATIONS

Polly, Jr. et al., "Surgical Treatment for the Painful Motion Segment", *Spine*, 2005, pp. S44-S51, vol. 30, No. 16S, published by Lippincott Williams & Wilkins, Inc.
Powers, et al., "Minimally Invasive Fusion and Fixation Techniques", *Neurosurgery Clinics of North America*, Oct. 2006, pp. 447-489, vol. 17, Issue 4, published by Elsevier, Inc.
Seldomridge, et al., "Minimally Invasive Spine Surgery", *The American Journal of Orthopedics*, May 2005, pp. 224-232.
Stein, et al., "Percutaneous Facet Joint Fusion: Preliminary Experience", *Journal of Vascular and Interventional Radiology*, Jan.-Feb. 1993, pp. 69-74, vol. 4, No. 1.

* cited by examiner

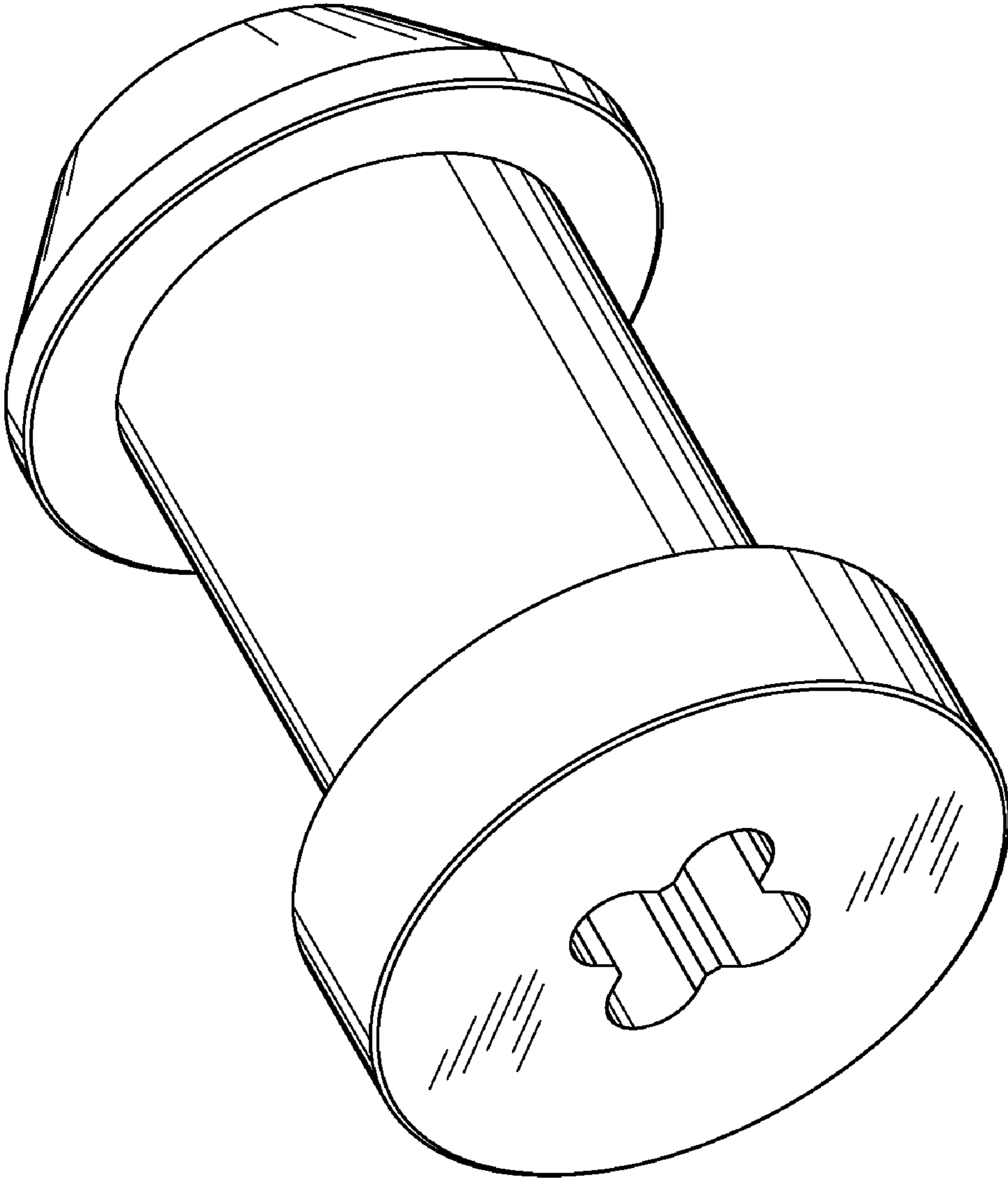

FIG. 1

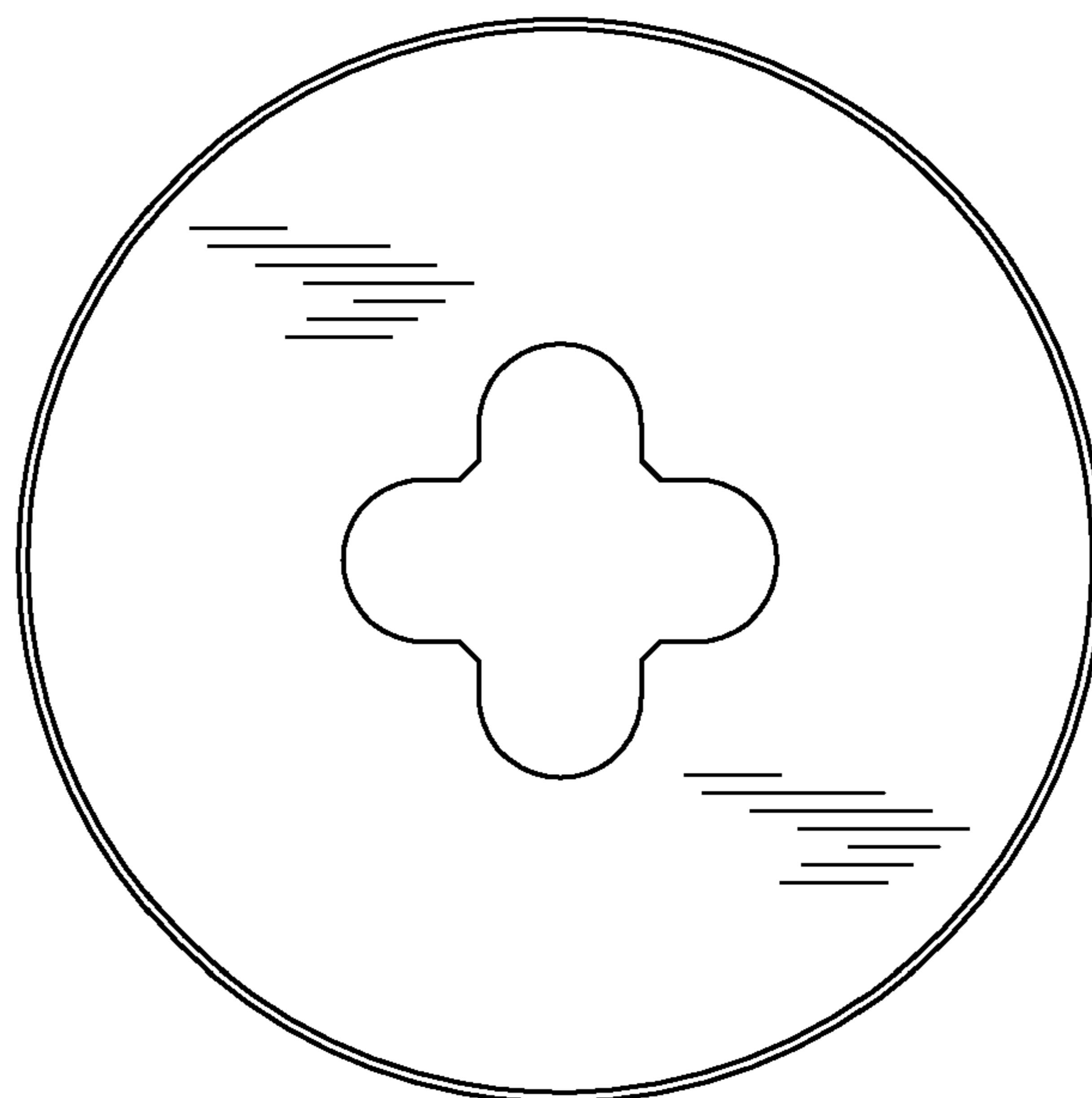

FIG. 2

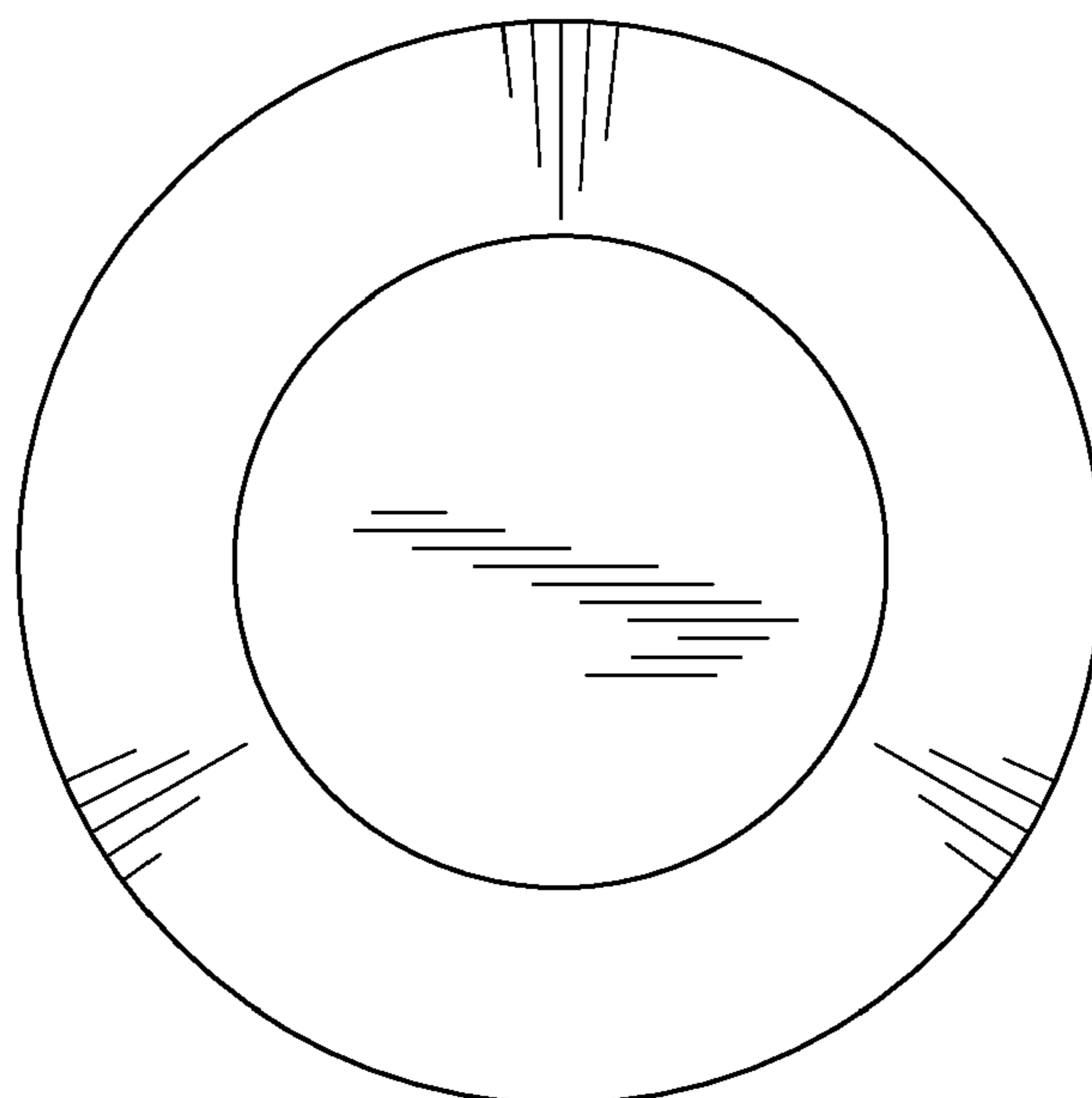

FIG. 3

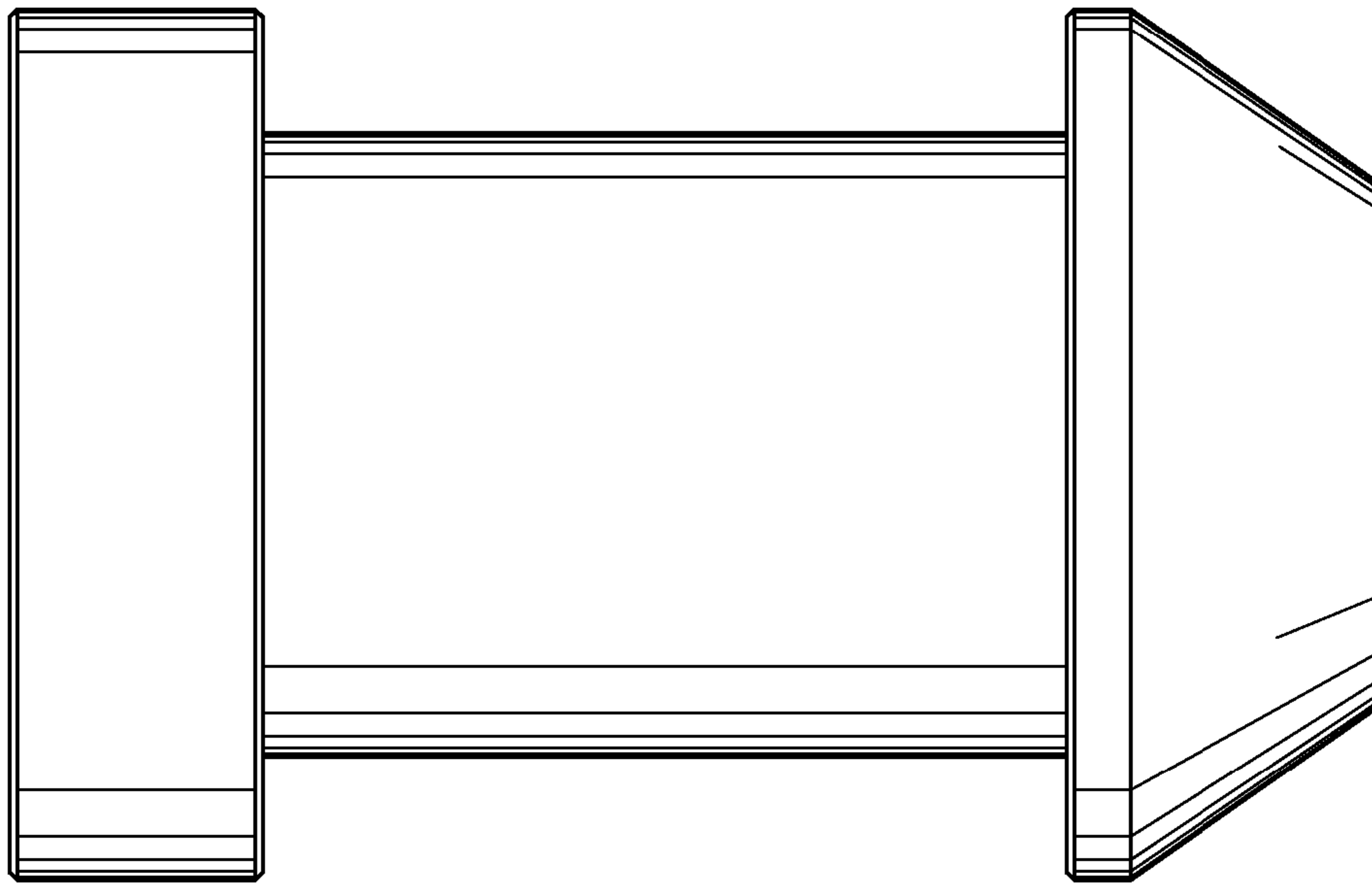

FIG. 4

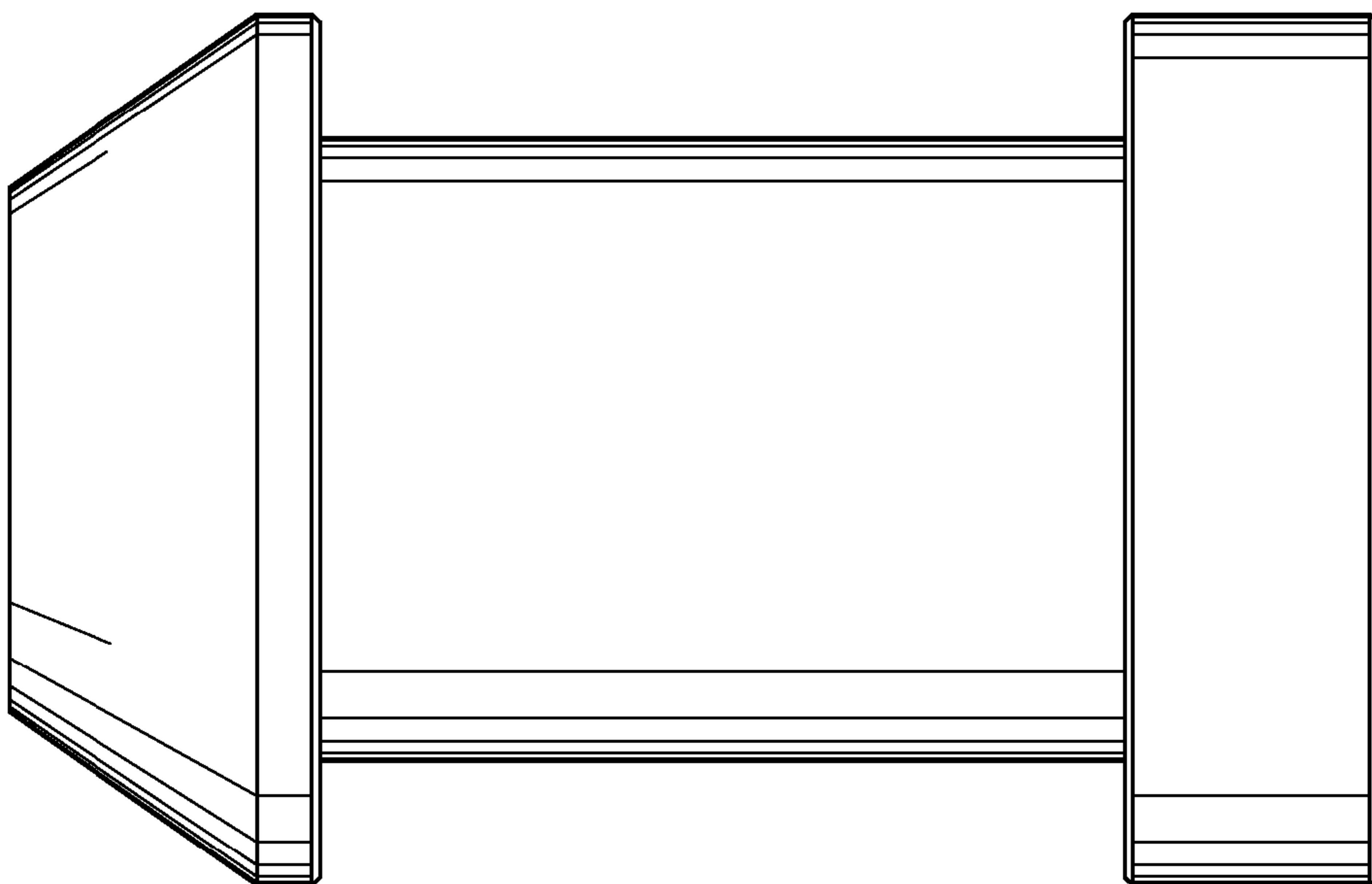

FIG. 5

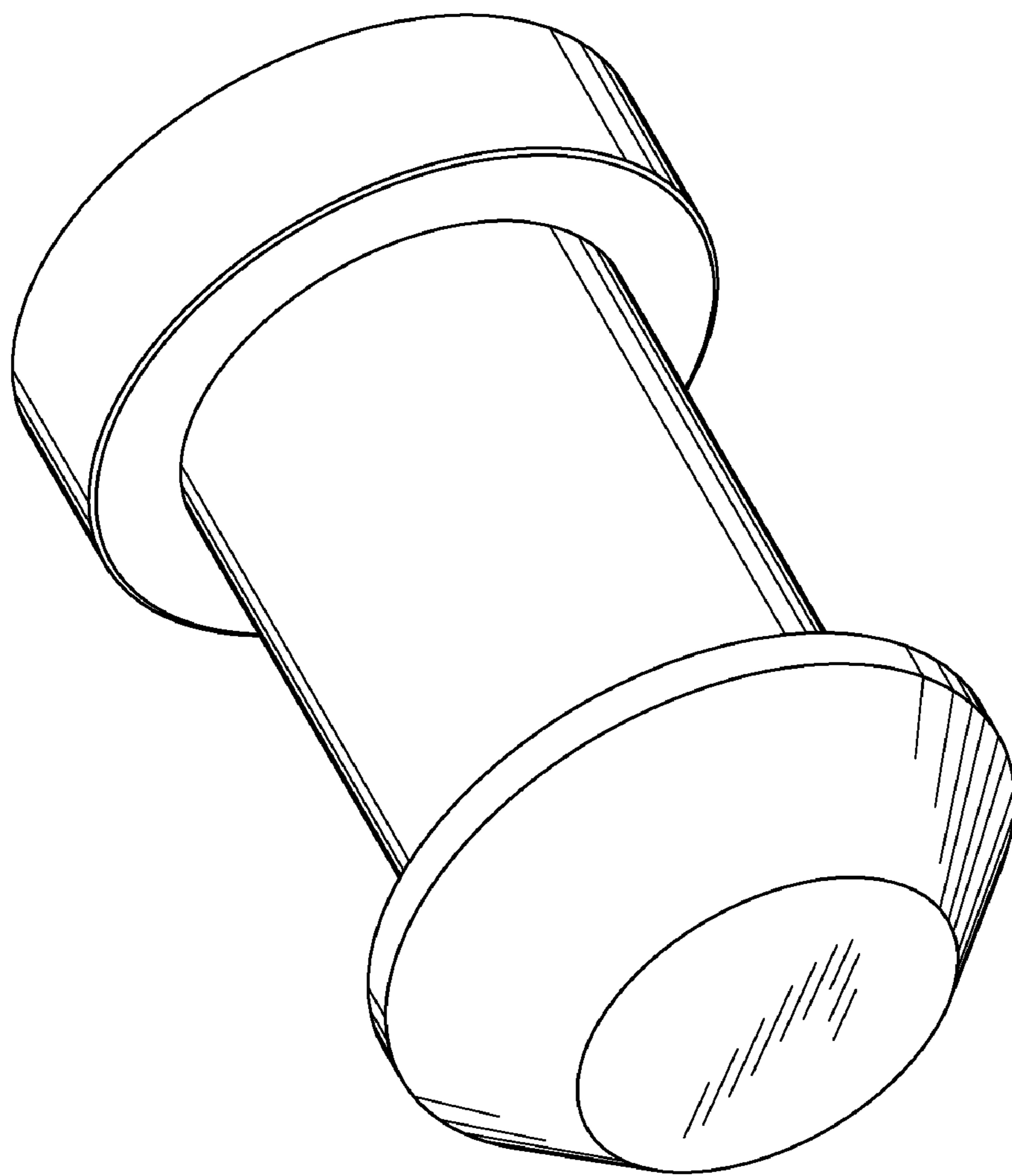

FIG. 6

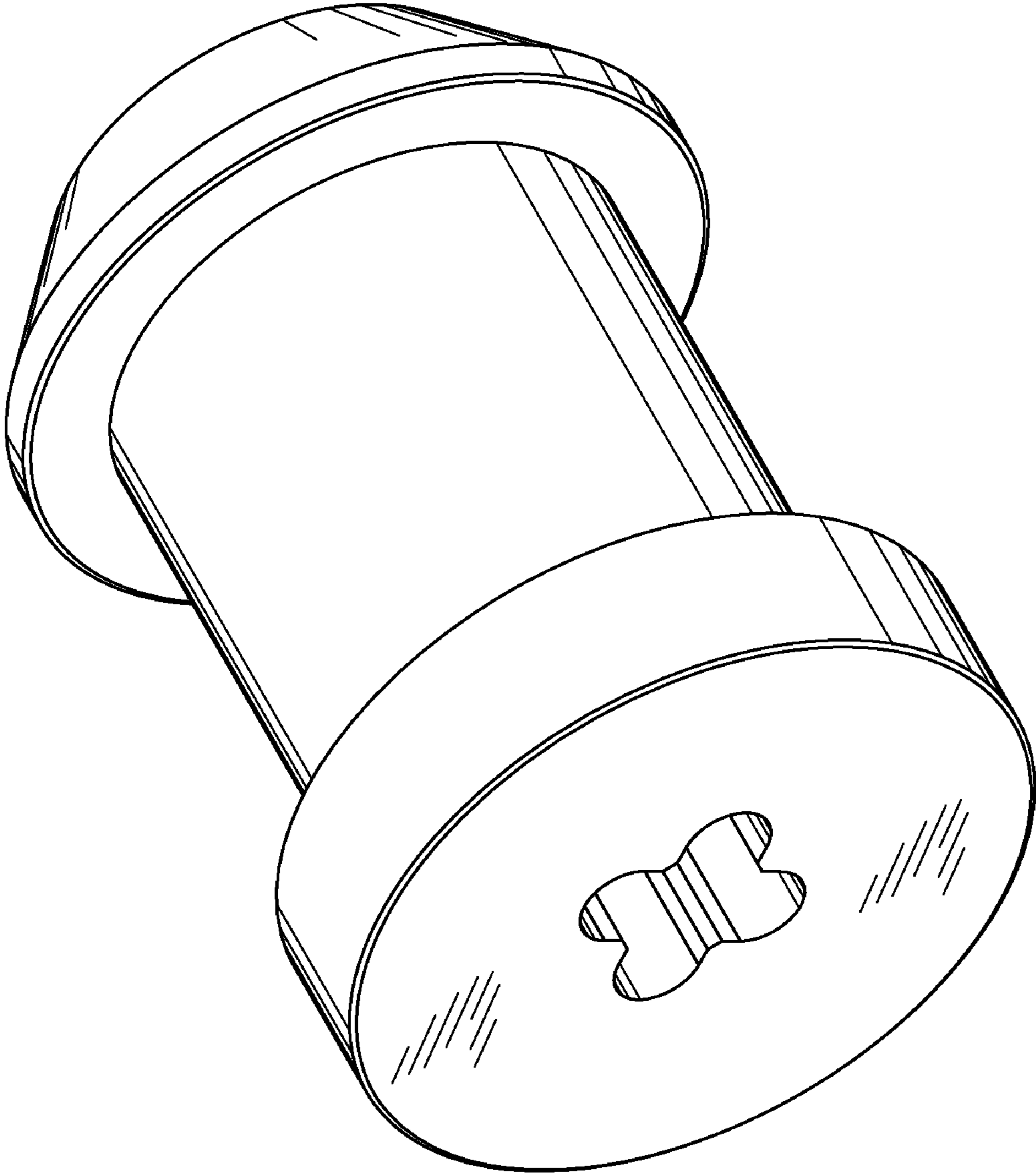

FIG. 7

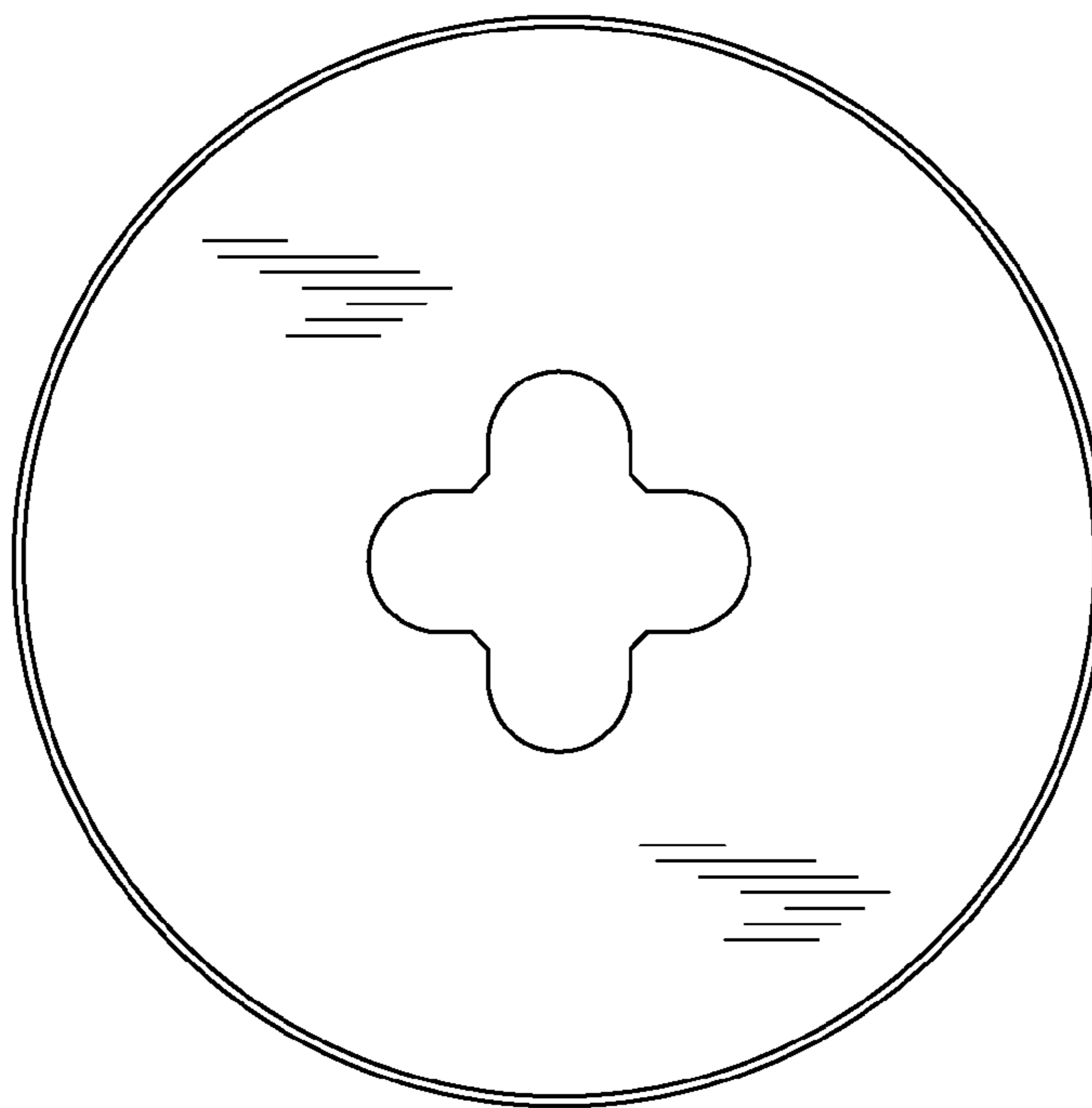

FIG. 8

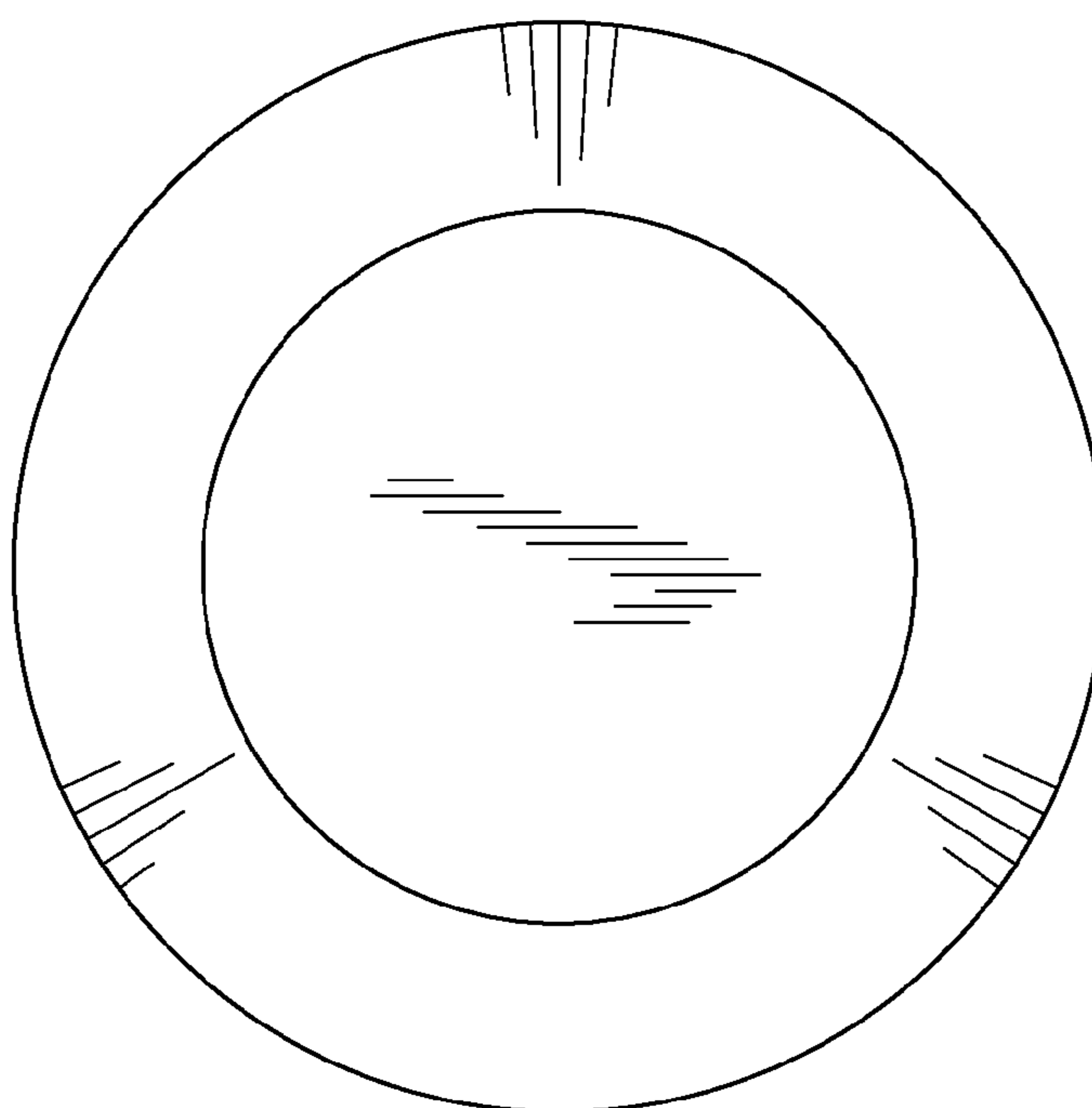

FIG. 9

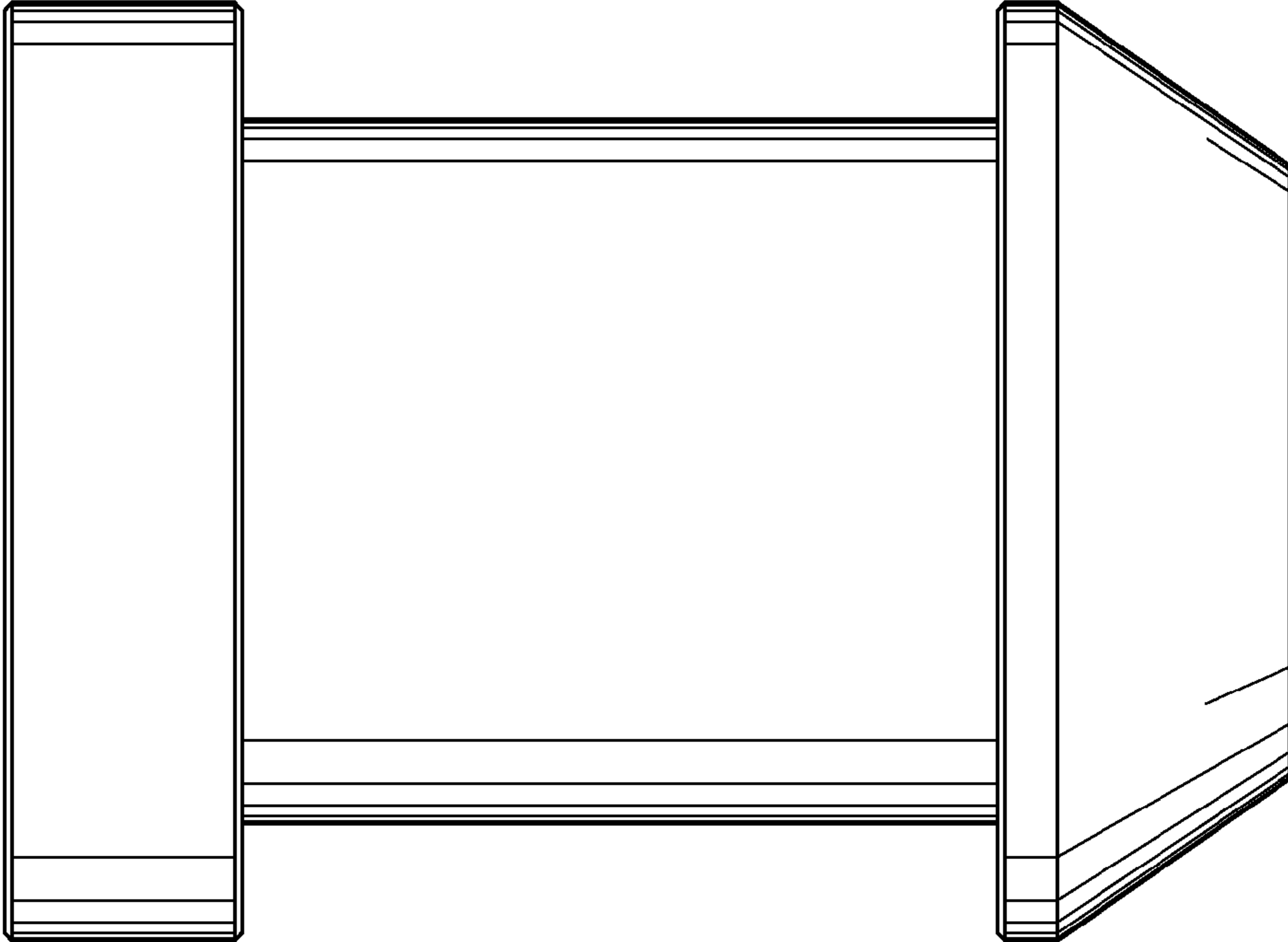

FIG. 10

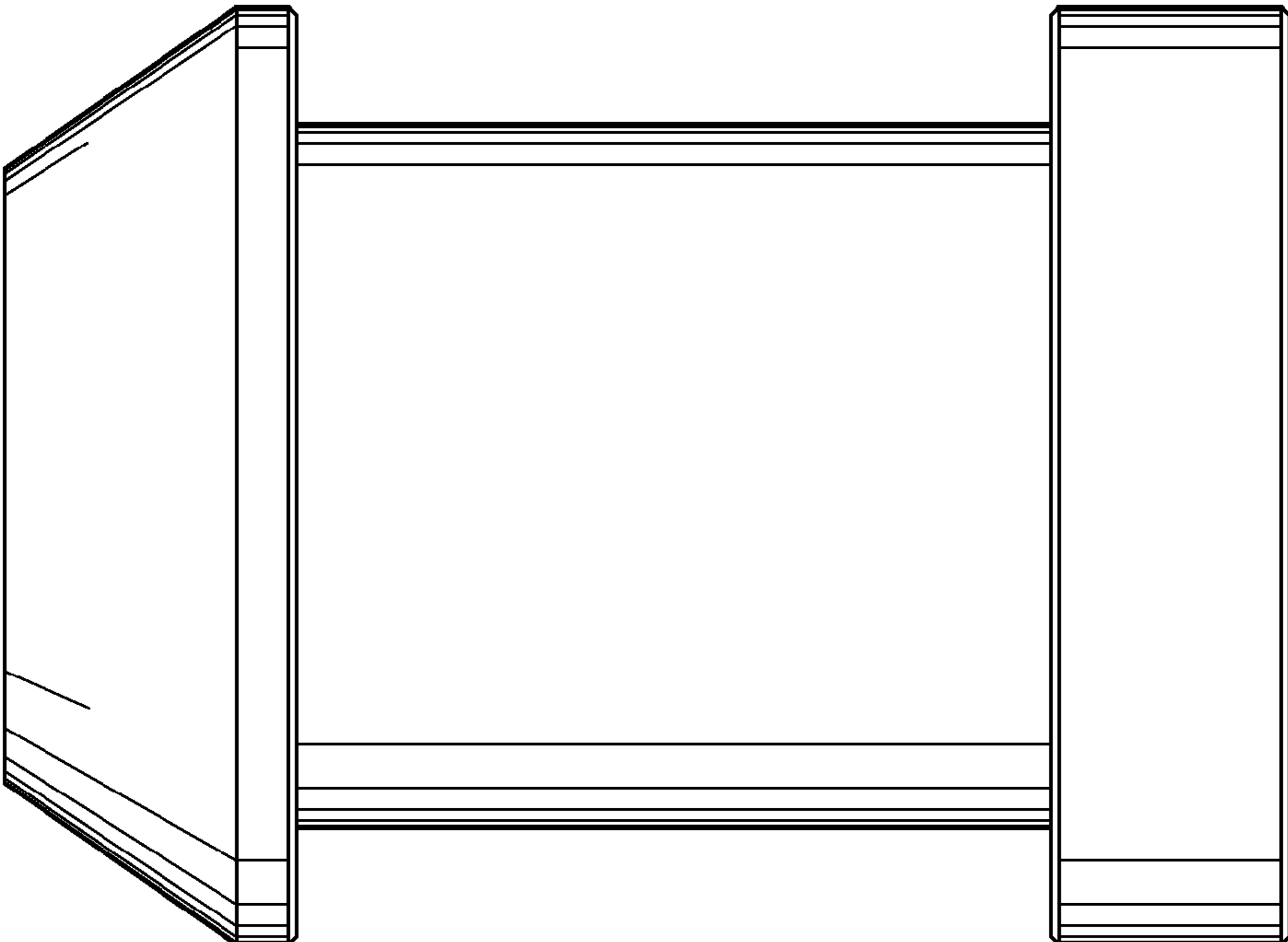

FIG. 11

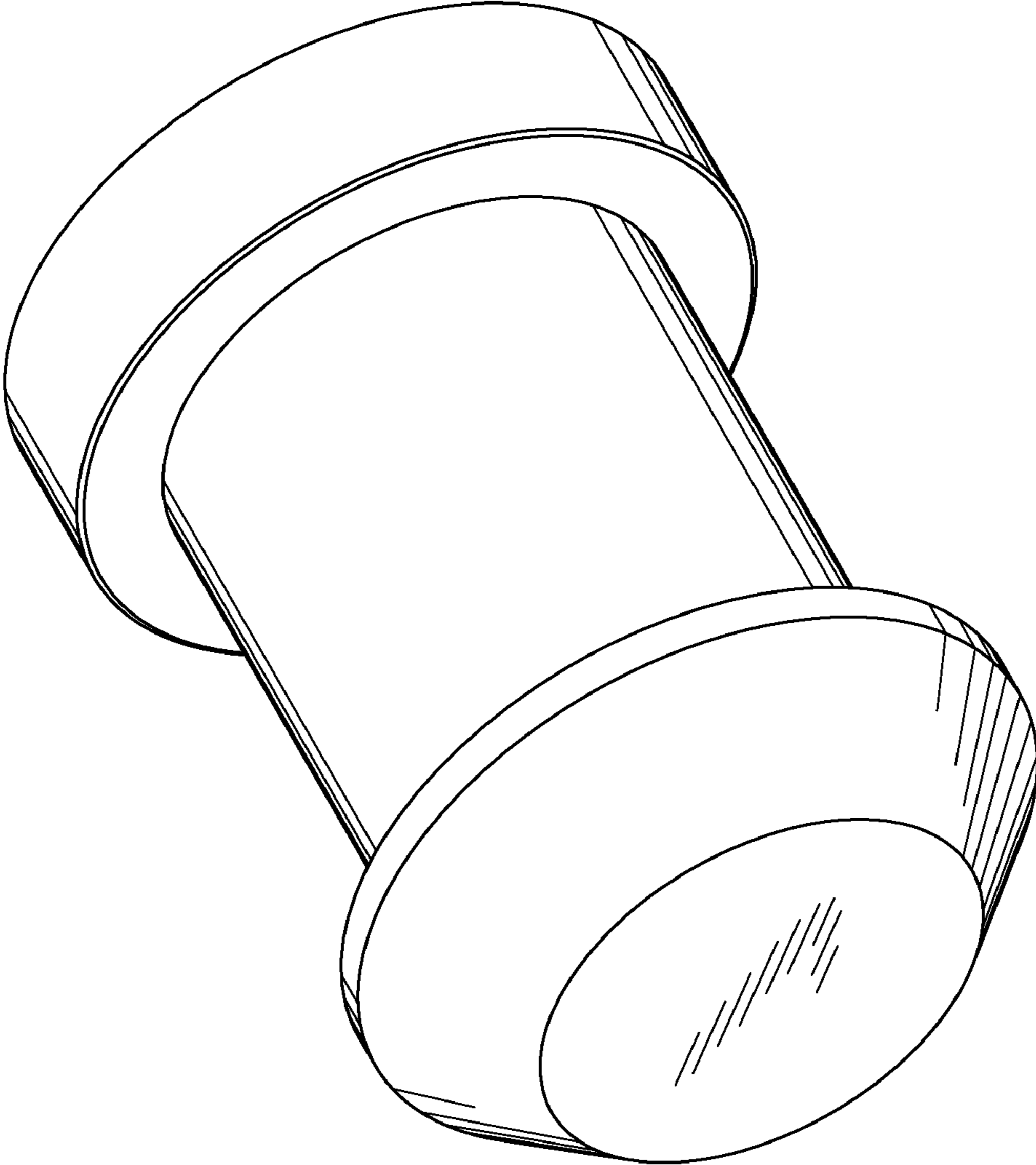

FIG. 12