



US00D629469S

(12) **United States Design Patent**  
**Nishimoto**

(10) **Patent No.:** **US D629,469 S**

(45) **Date of Patent:** **\*\* Dec. 21, 2010**

(54) **TOY TOP**

7,427,225 B2 9/2008 Matsukawa et al.  
D584,366 S 1/2009 Bowen et al.  
D608,842 S 1/2010 Nishimoto  
D610,209 S 2/2010 Nishimoto

(75) Inventor: **Hisao Nishimoto**, Tokyo (JP)

(73) Assignee: **Tomy Company, Ltd.**, Tokyo (JP)

(\*\*) Term: **14 Years**

(Continued)

(21) Appl. No.: **29/347,646**

CN 3262744 \* 11/2002

(22) Filed: **Mar. 26, 2010**

(Continued)

(30) **Foreign Application Priority Data**

OTHER PUBLICATIONS

Sep. 28, 2009 (JP) ..... 2009-22308

Abstract of Japanese Publication No. 3156926, published Feb. 27, 2001.

(51) **LOC (9) Cl.** ..... **21-01**

(Continued)

(52) **U.S. Cl.** ..... **D21/460**

(58) **Field of Classification Search** ..... D21/385,  
D21/386, 390, 398, 404, 436-438, 441-444,  
D21/447, 451, 453-464, 563, 578, 585, 592;  
446/34, 36-48, 217, 218, 330, 352, 358,  
446/359, 366, 368, 421, 429, 430, 486, 489  
See application file for complete search history.

Primary Examiner—Catherine Tuttle

(74) *Attorney, Agent, or Firm*—Staas & Halsey LLP

(57) **CLAIM**

The ornamental design for a toy top, as shown and described.

**DESCRIPTION**

(56) **References Cited**

**U.S. PATENT DOCUMENTS**

461,948 A	10/1891	Wilson
1,552,530 A	8/1921	Woods
D155,015 S	8/1949	Krapp
2,789,392 A	4/1957	Palmieri
3,220,142 A	11/1965	Butterfield
3,613,295 A	10/1971	Everett
4,157,632 A	6/1979	Everett
D262,610 S	1/1982	Westlake et al.
D353,632 S	12/1994	Nonaka et al.
D356,347 S	3/1995	Nonaka et al.
5,518,437 A	5/1996	Nonaka et al.
5,593,338 A	1/1997	Itoh et al.
6,604,979 B1	8/2003	Liu
6,626,729 B2	9/2003	Osawa
6,739,939 B2	5/2004	Matsukawa
6,743,070 B1	6/2004	Lin
6,746,300 B1	6/2004	Matsukawa
6,905,389 B2	6/2005	Matsukawa
7,063,589 B2	6/2006	Matsukawa et al.

FIG. 1 is a front perspective view of the toy top showing my design;

FIG. 2 is a rear perspective view thereof;

FIG. 3 is a right side perspective view thereof;

FIG. 4 is a left side perspective view thereof;

FIG. 5 is a rear underside perspective view thereof;

FIG. 6 is a top plan elevation view thereof;

FIG. 7 is a bottom plan elevation view thereof;

FIG. 8 is a front orthographic elevation view thereof;

FIG. 9 is a rear orthographic elevation view thereof;

FIG. 10 is a right side elevation view thereof;

FIG. 11 is a left side elevation view thereof; and,

FIG. 12 is a disassembled perspective view thereof.

The broken lines are for the purpose of illustrating portions of the toy top that form no part of the claimed design.

**1 Claim, 7 Drawing Sheets**

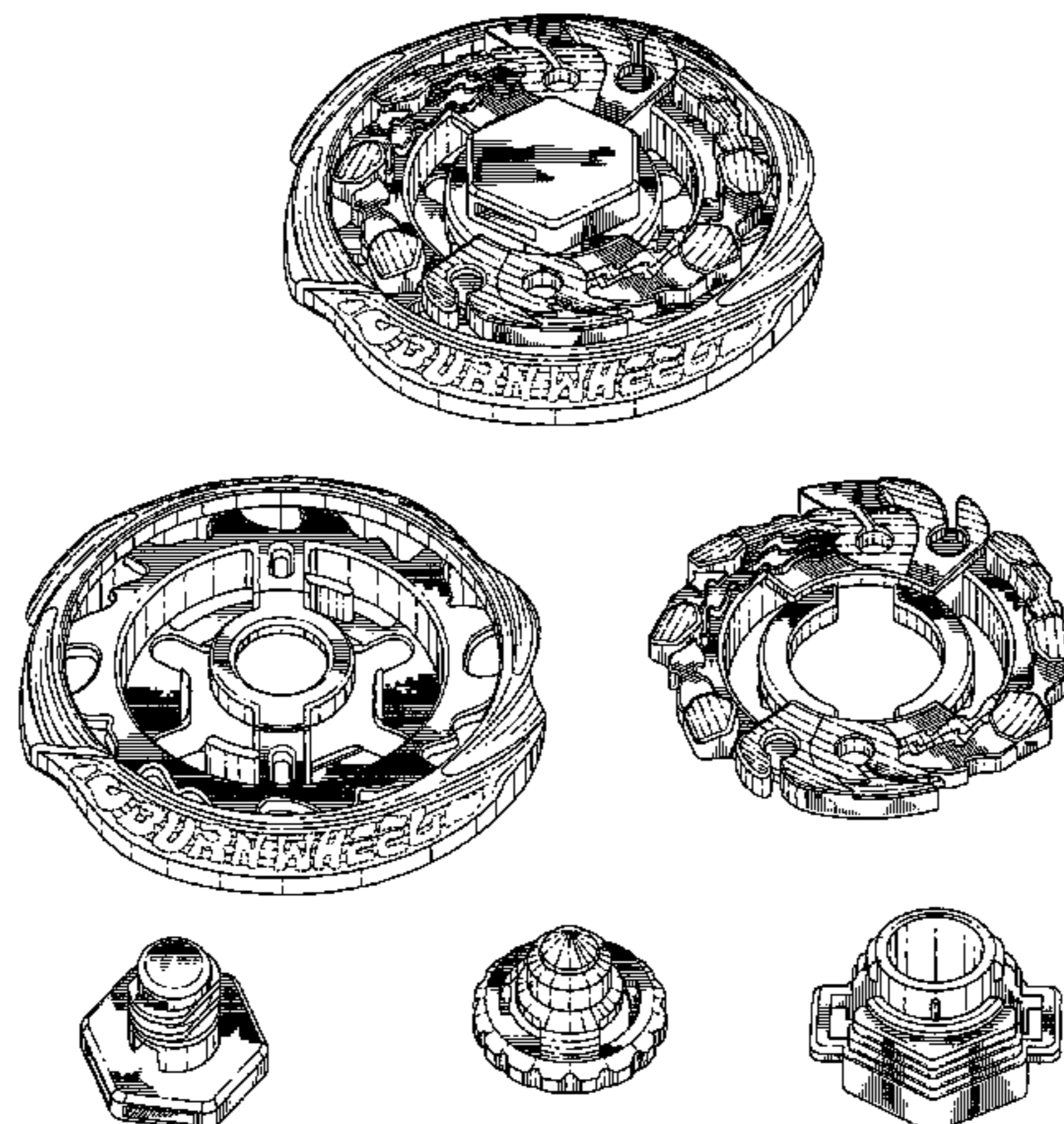

U.S. PATENT DOCUMENTS

D610,210 S 2/2010 Nishimoto  
 D610,211 S 2/2010 Nishimoto  
 2002/0102907 A1 8/2002 Osawa  
 2003/0064660 A1 4/2003 Matsukawa  
 2004/0198152 A1 10/2004 Matsukawa  
 2006/0258259 A1 11/2006 Lin

FOREIGN PATENT DOCUMENTS

CN 2604212 Y 2/2004  
 CN 3618938 \* 3/2007  
 CN 2925561 Y 7/2007  
 CN 3666036 \* 7/2007  
 CN 200977395 Y 11/2007  
 CN 200977396 Y 11/2007  
 CN 200977397 Y 11/2007  
 CN 200977398 Y 11/2007  
 CN 20098446 Y 12/2007  
 CN 300819266 \* 8/2008  
 CN 300819268 \* 8/2008  
 CN 300830960 \* 9/2008  
 CN 300837565 \* 10/2008  
 CN 300846669 \* 11/2008  
 DE 2002 07 253 10/2002  
 EM 077438 4/1983  
 JP 3067318 3/2000  
 JP 3071356 8/2000  
 JP 3156926 2/2001  
 JP 3079301 5/2001  
 JP 2003-320174 A 11/2003  
 JP 2005-328976 12/2005  
 KR 300520344.000 \* 2/2009

OTHER PUBLICATIONS

Abstract of Japanese Publication No. 2005-328976, published Dec. 2, 2005.  
 European Search Report in Application No. 08253264.9 dated Jun. 25, 2009.  
 Patent Abstracts of China, Publication No. 201214014, Published Apr. 1, 2009.  
 U.S. Copyright Registration No. VA1-151-590 dated Nov. 15, 2002 with deposit copy.  
 U.S. Copyright Registration No. VA1-151-591 dated Nov. 15, 2002 with deposit copy.  
 U.S. Copyright Registration No. VA1-151-592 dated Nov. 15, 2002 with deposit copy.  
 U.S. Copyright Registration No. VA1-151-593 dated Nov. 15, 2002 with deposit copy.  
 U.S. Copyright Registration No. VA1-151-594 dated Nov. 15, 2002 with deposit copy.  
 U.S. Copyright Registration No. VA1-151-595 dated Nov. 15, 2002 with deposit copy.  
 U.S. Copyright Registration No. VA1-172-925 dated Oct. 22, 2002 with deposit copy.  
 U.S. Copyright Registration No. VA1-172-926 dated Oct. 22, 2002 with deposit copy.  
 U.S. Copyright Registration No. VA1-172-927 dated Oct. 22, 2002 with deposit copy.

U.S. Copyright Registration No. VA1-172-928 dated Oct. 22, 2002 with deposit copy.  
 U.S. Copyright Registration No. VA1-172-929 dated Oct. 22, 2002 with deposit copy.  
 U.S. Copyright Registration No. VA1-172-931 dated Oct. 22, 2002 with deposit copy.  
 U.S. Copyright Registration No. VA1-172-932 dated Oct. 22, 2002 with deposit copy.  
 U.S. Copyright Registration No. VA1-172-933 dated Oct. 22, 2002 with deposit copy.  
 U.S. Copyright Registration No. VA1-172-934 dated Oct. 22, 2002 with deposit copy.  
 U.S. Copyright Registration No. VA1-172-935 dated Oct. 22, 2002 with deposit copy.  
 Apr. 2, 2009 Office Action in co-pending U.S. Appl. No. 29/309,758.  
 Apr. 7, 2009 Notice of Allowance in co-pending U.S. Appl. No. 29/309,762.  
 Apr. 7, 2009 Notice of Allowance in co-pending U.S. Appl. No. 29/309,764.  
 Apr. 15, 2009 Office Action in co-pending U.S. Appl. No. 29/309,759.  
 Apr. 15, 2009 Office Action in co-pending U.S. Appl. No. 29/309,761.  
 Apr. 15, 2009 Office Action in co-pending U.S. Appl. No. 29/309,766.  
 Apr. 16, 2009 Office Action in co-pending U.S. Appl. No. 29/309,768.  
 Sep. 3, 2009 Notice of Allowance in co-pending U.S. Appl. No. 29/309,762.  
 Sep. 3, 2009 Notice of Allowance in co-pending U.S. Appl. No. 29/309,764.  
 Office Action mailed Nov. 27, 2009 in co-pending U.S. Appl. No. 29/311,821.  
 Office Action mailed Nov. 27, 2009 in co-pending U.S. Appl. No. 29/311,775.  
 Notice of Allowance mailed Nov. 30, 2009 in co-pending U.S. Appl. No. 29/309,766.  
 Notice of Allowance mailed Nov. 30, 2009 in co-pending U.S. Appl. No. 29/309,758.  
 Notice of Allowance mailed Dec. 1, 2009 in co-pending U.S. Appl. No. 29/311,777.  
 U.S. Appl. No. 29/309,758, filed Oct. 6, 2008, Nishimoto, Tomy Company, Ltd.  
 U.S. Appl. No. 29/309,766, filed Oct. 6, 2008, Nishimoto, Tomy Company, Ltd.  
 U.S. Appl. No. 29/285,877, filed Oct. 15, 2008, Ujita et al., Tomy Company, Ltd.  
 U.S. Appl. No. 29/311,775, filed Jun. 17, 2009, Ujita, Tomy Company, Ltd.  
 U.S. Appl. No. 29/311,776, filed Jun. 17, 2009, Ujita, Tomy Company, Ltd.  
 U.S. Appl. No. 29/311,777, filed Jun. 17, 2009, Ujita, Tomy Company, Ltd.  
 U.S. Appl. No. 29/311,821, filed Jul. 2, 2009, Nishimoto, Tomy Company, Ltd.  
 U.S. Appl. No. 29/347,147, filed Sep. 28, 2009, Nishimoto, Tomy Company, Ltd.  
 U.S. Appl. No. 29/347,188, filed Oct. 20, 2008, Ujita, Tomy Company, Ltd.

\* cited by examiner

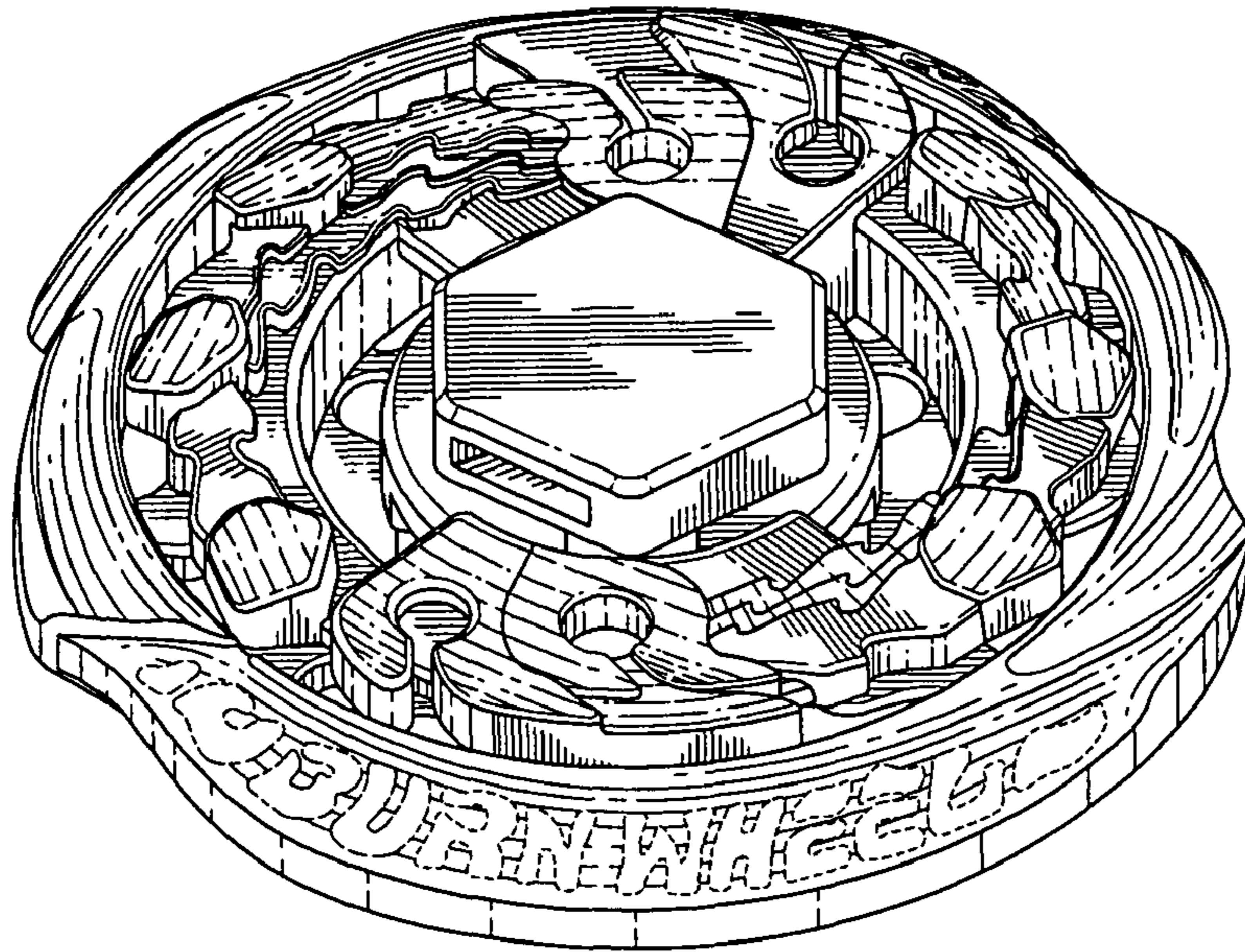

FIG. 1

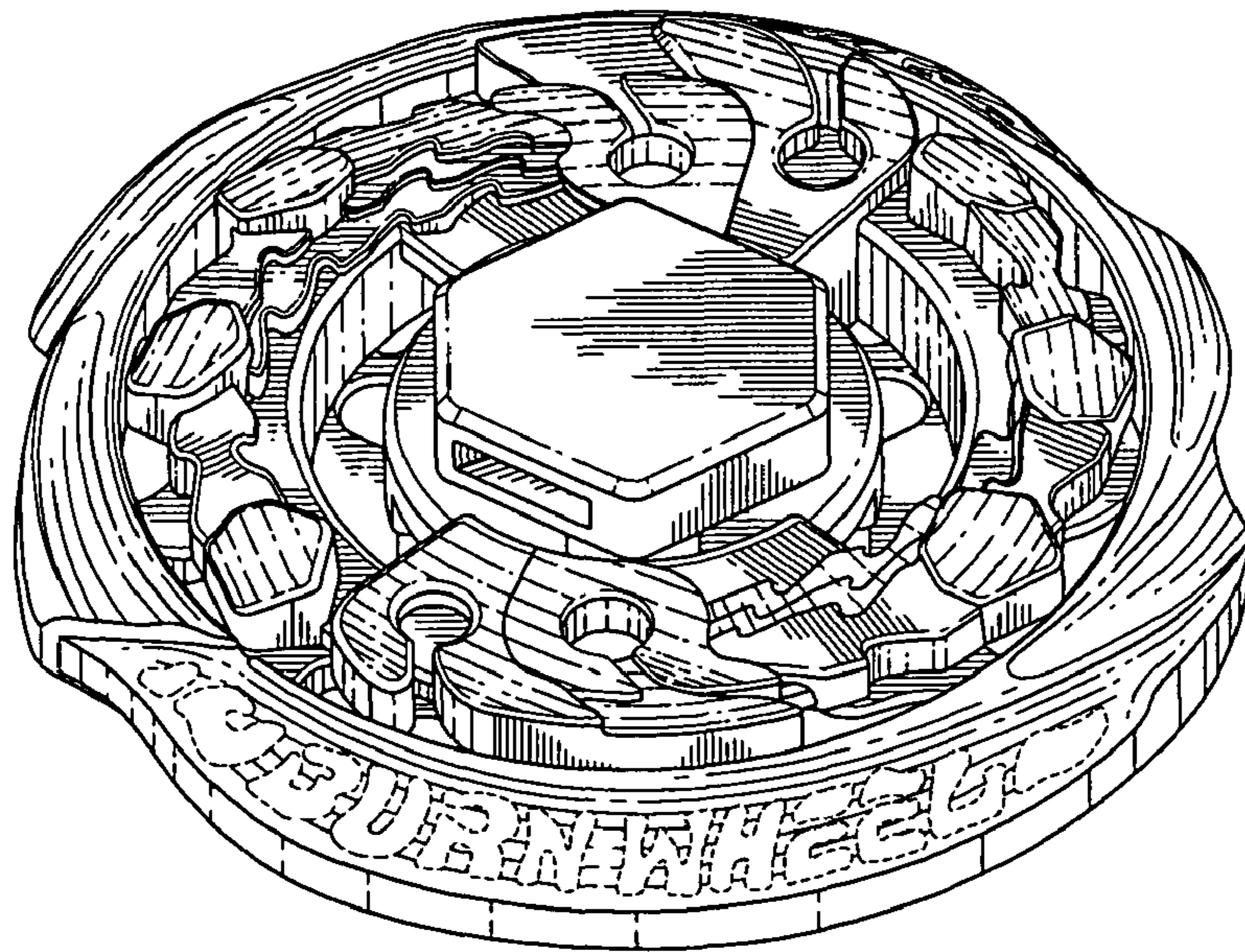

FIG. 2

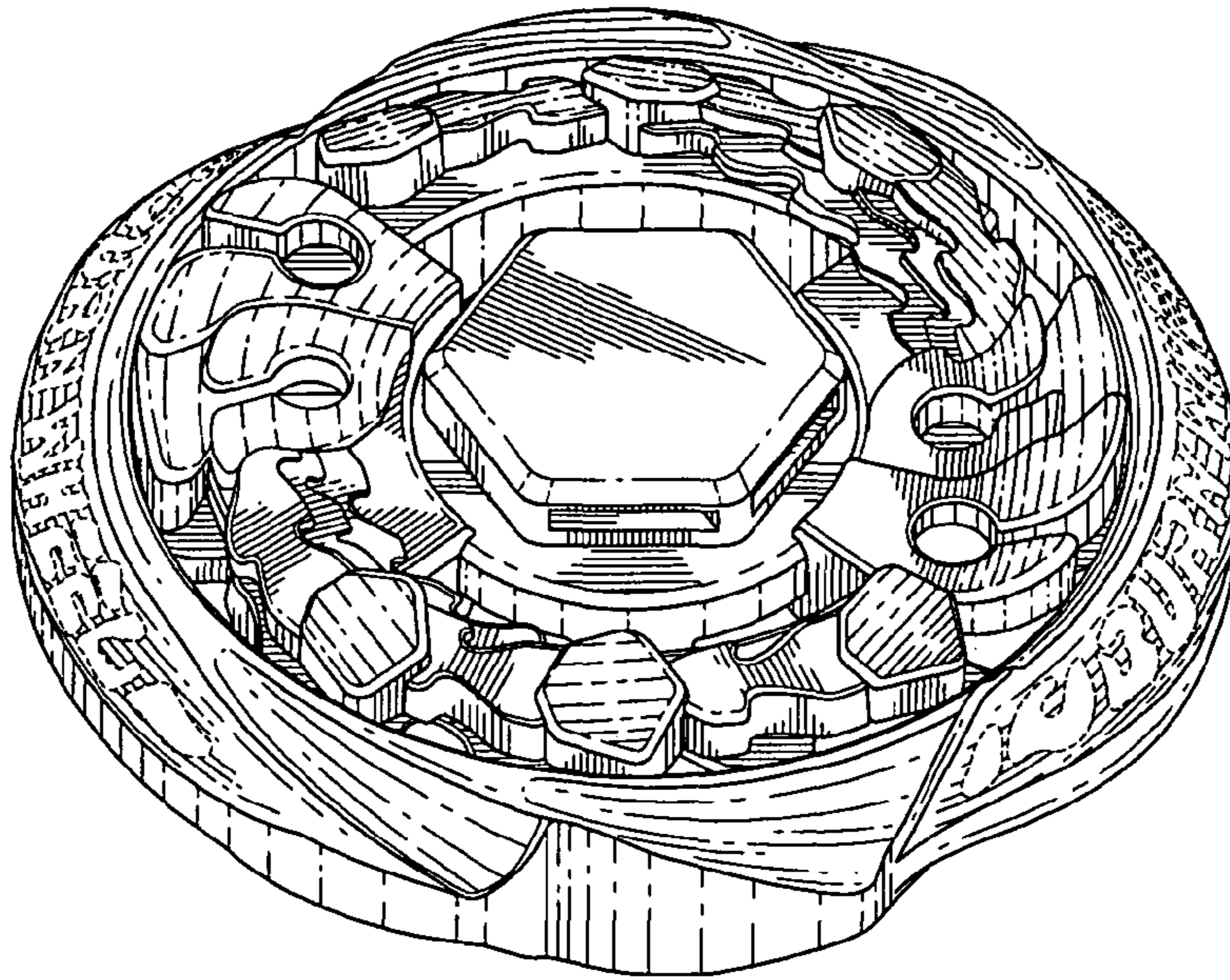

FIG. 3

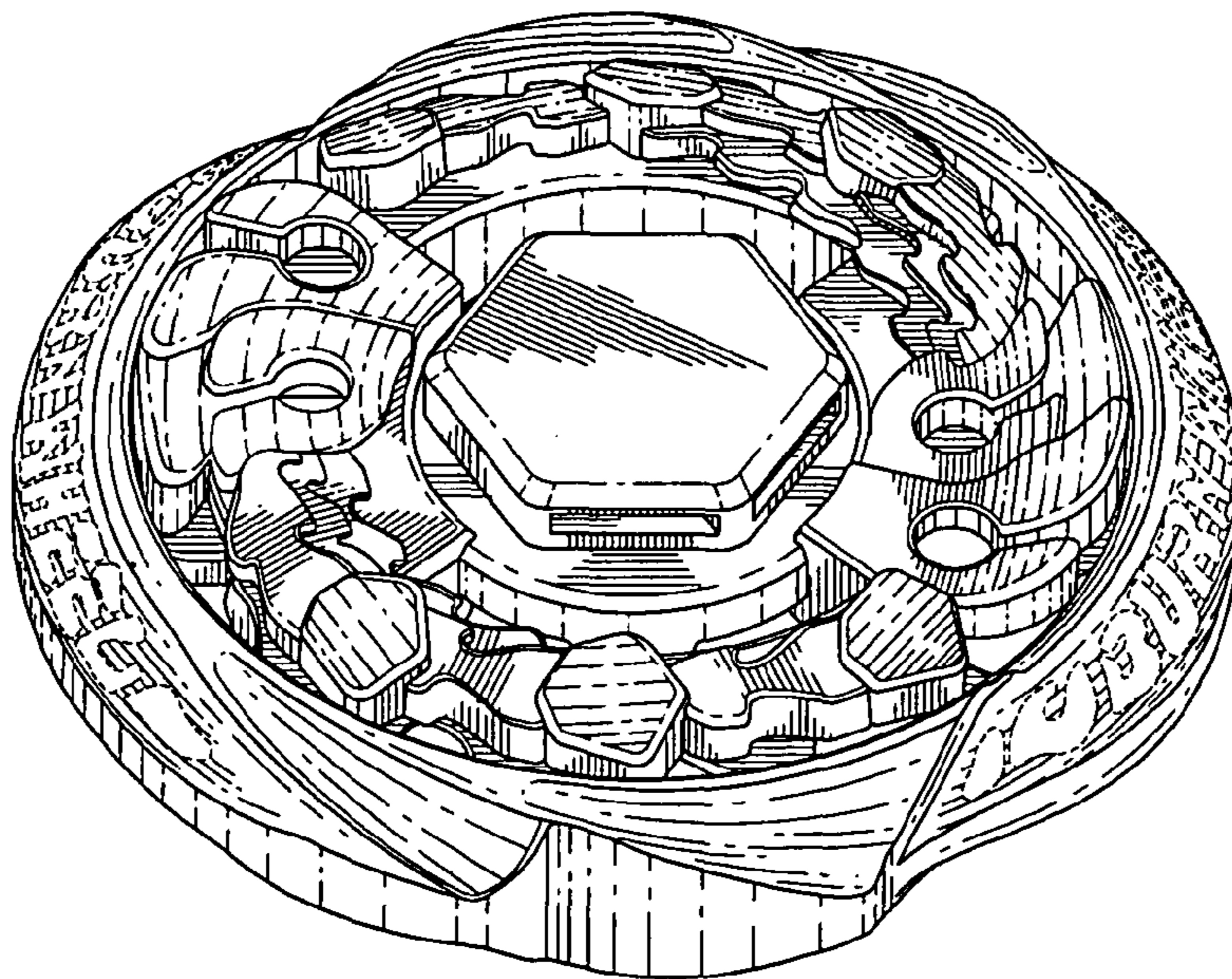

FIG. 4

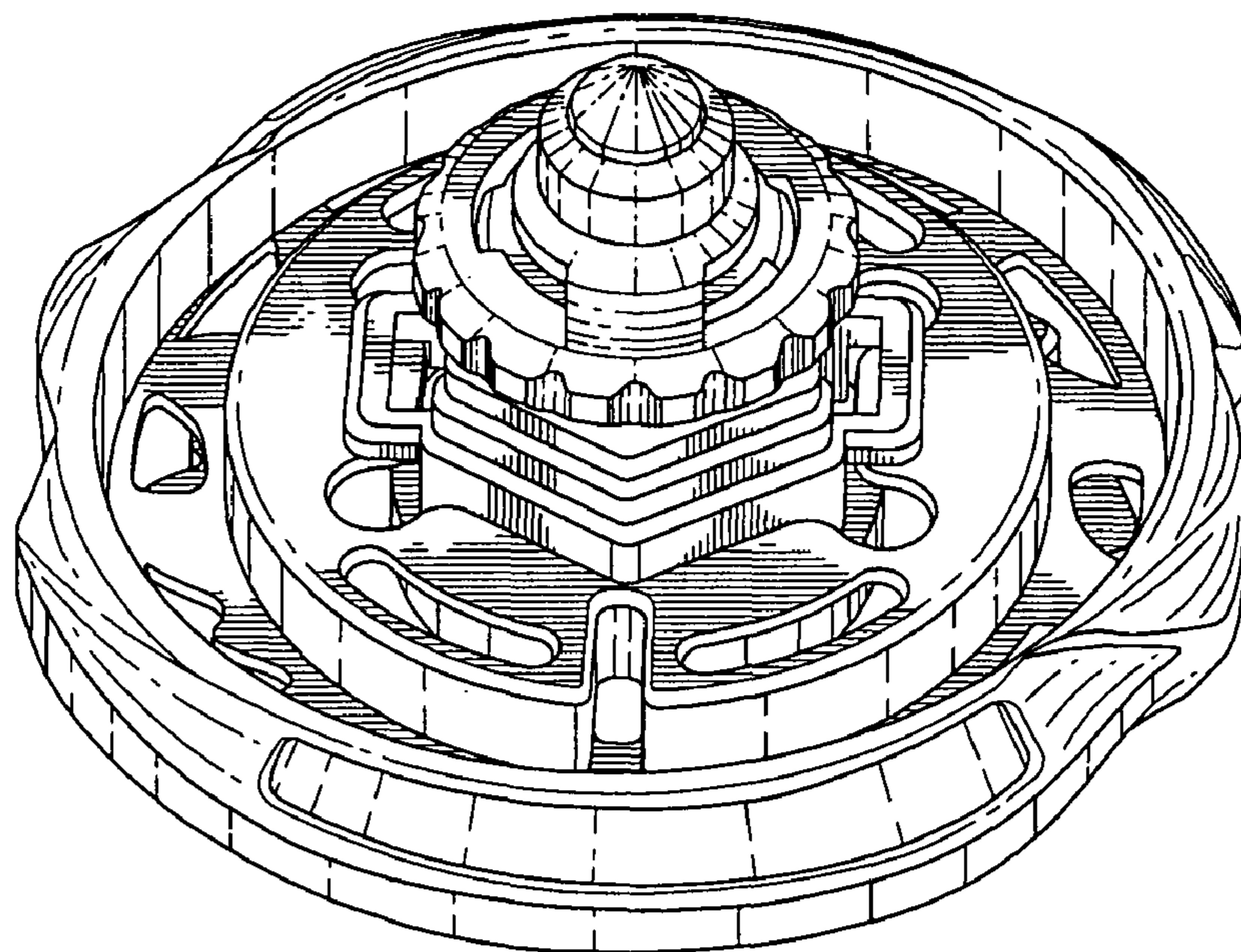

FIG. 5

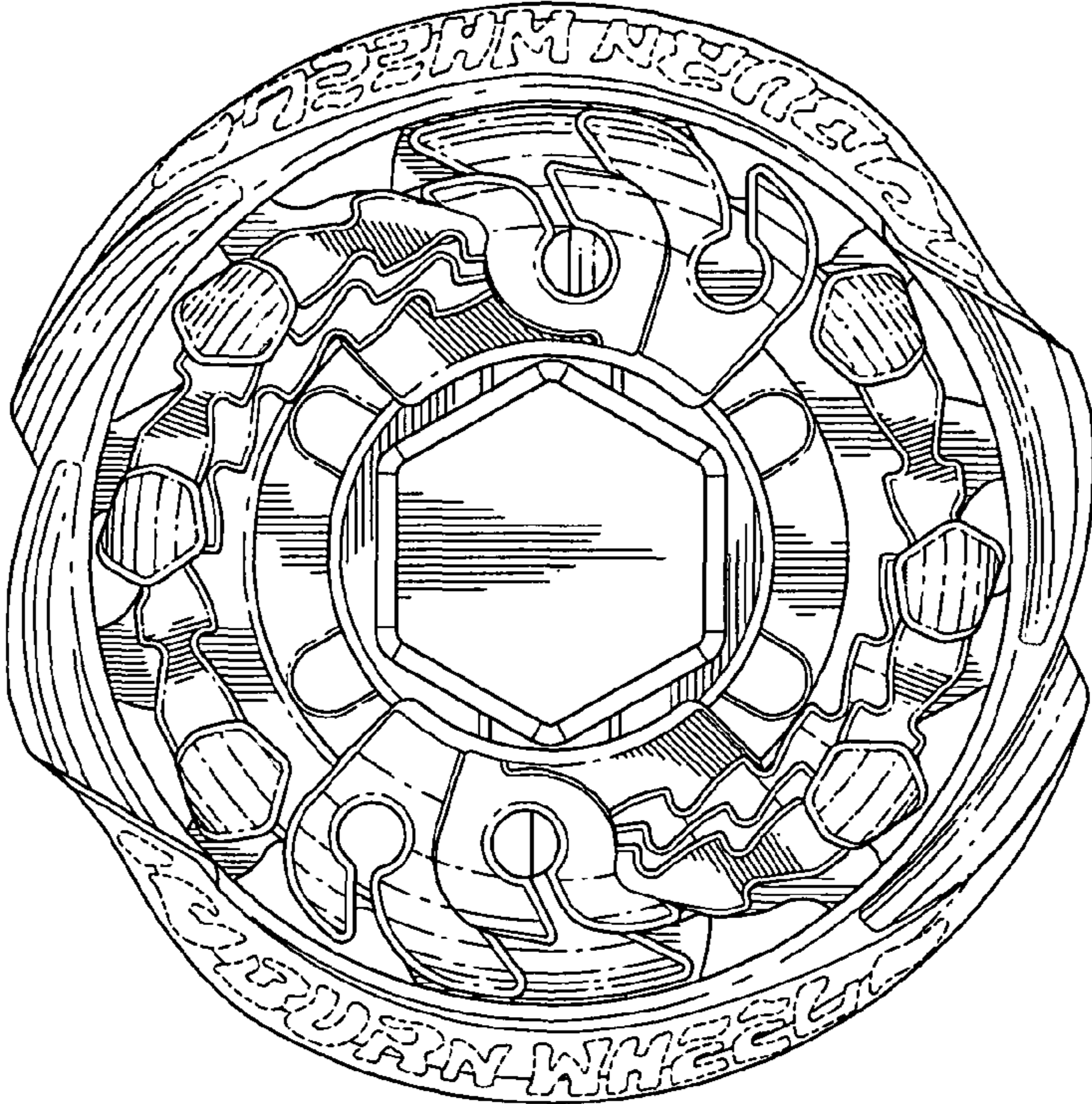

FIG. 6

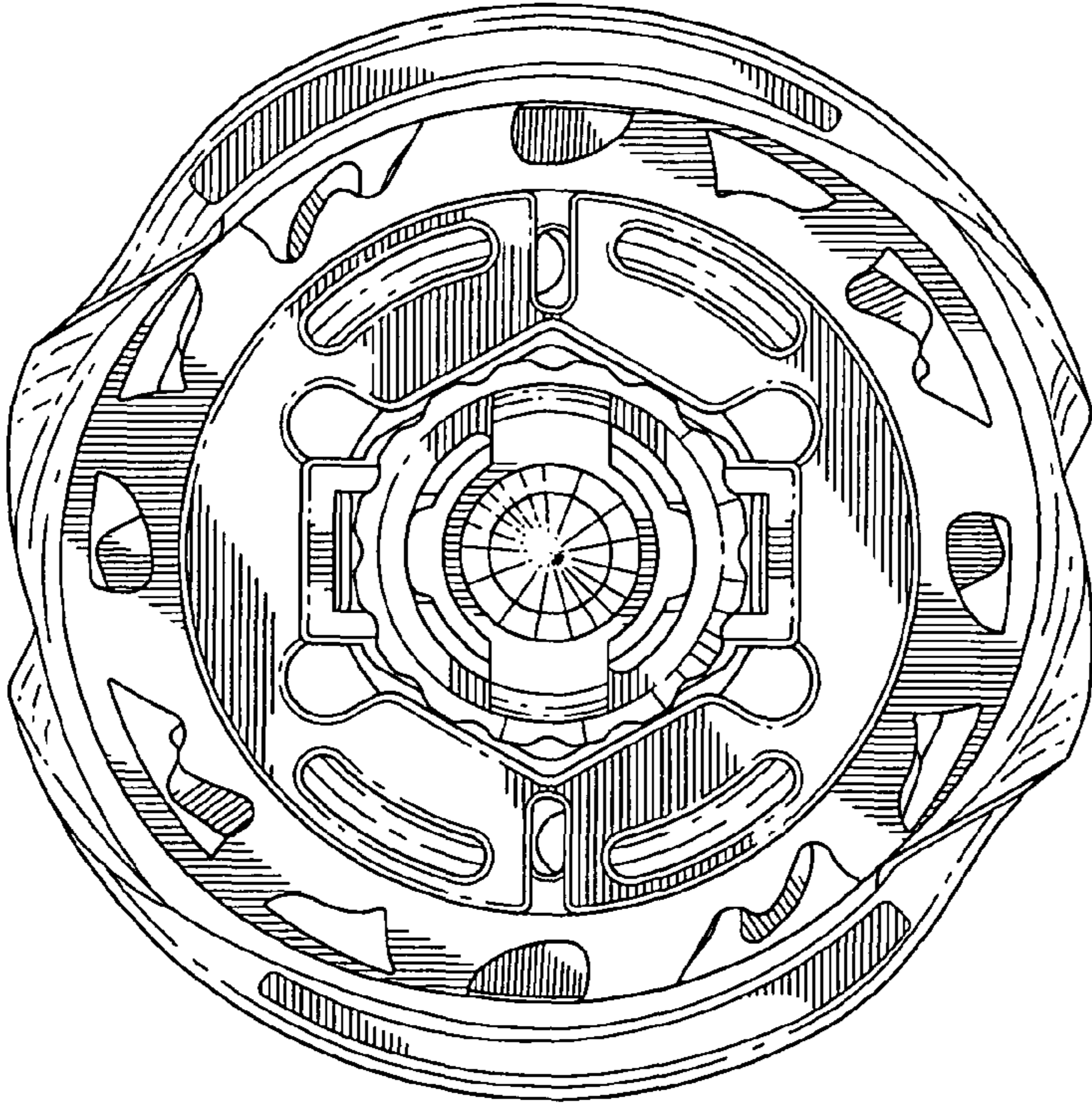

FIG. 7

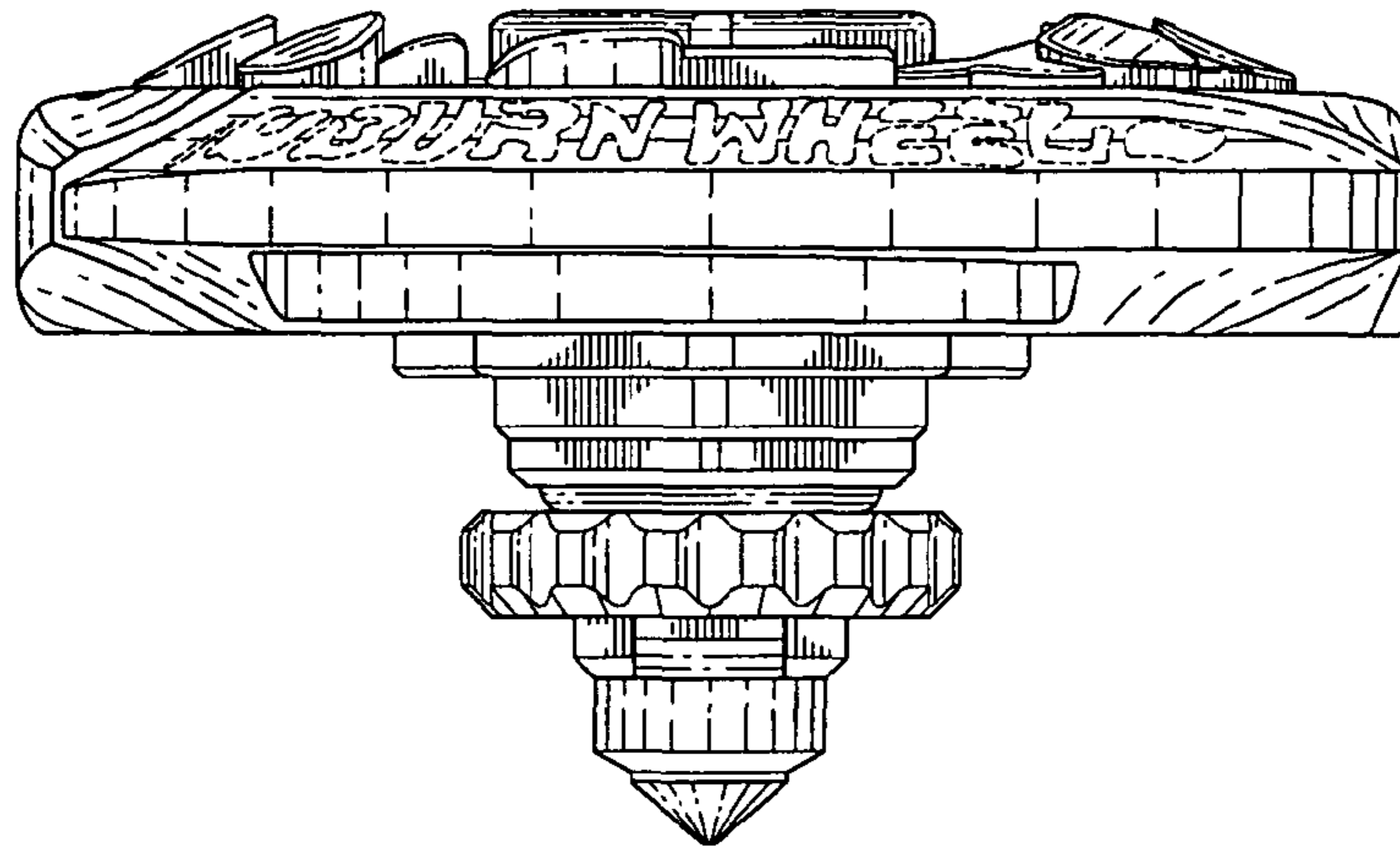

FIG. 8

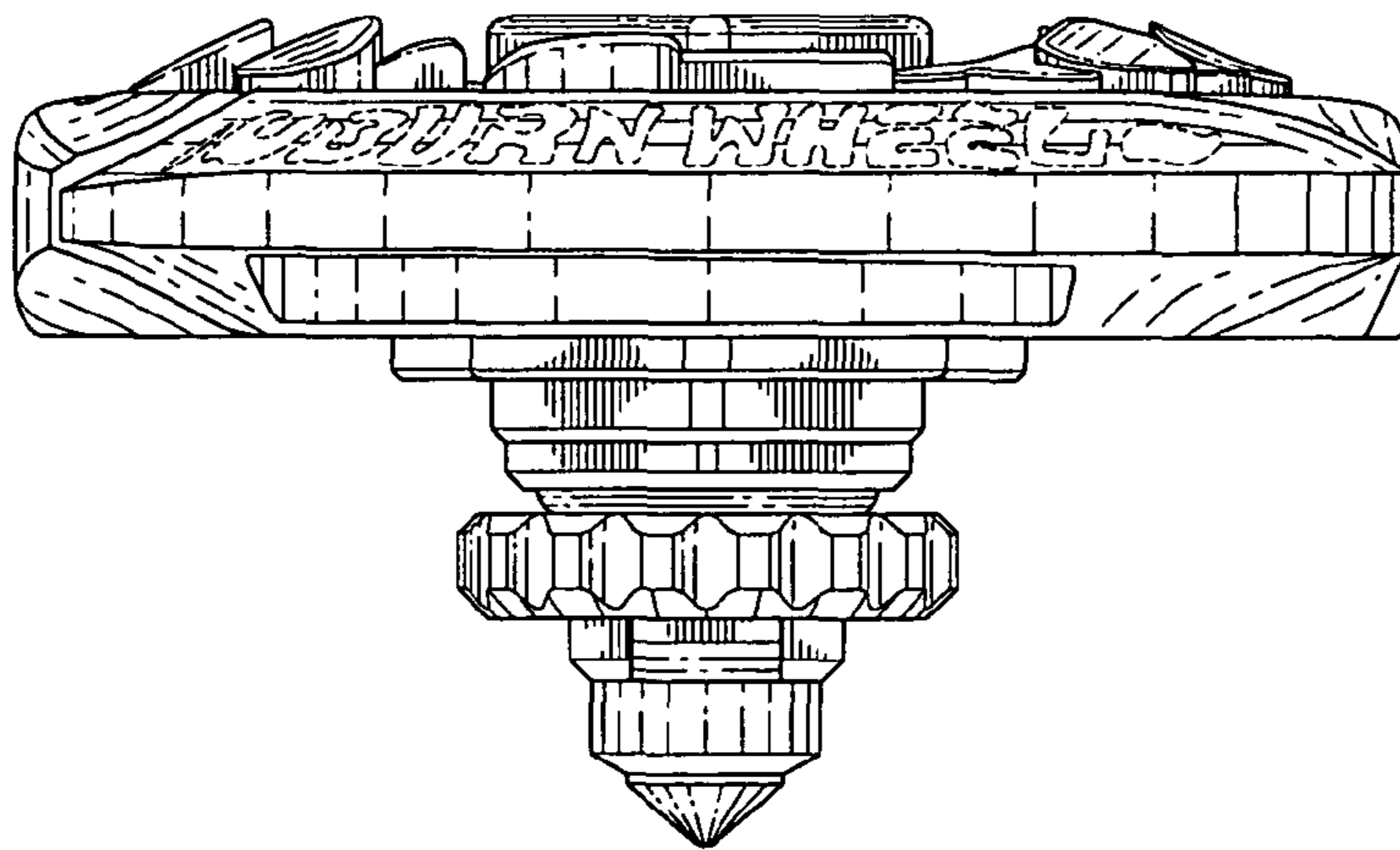

FIG. 9

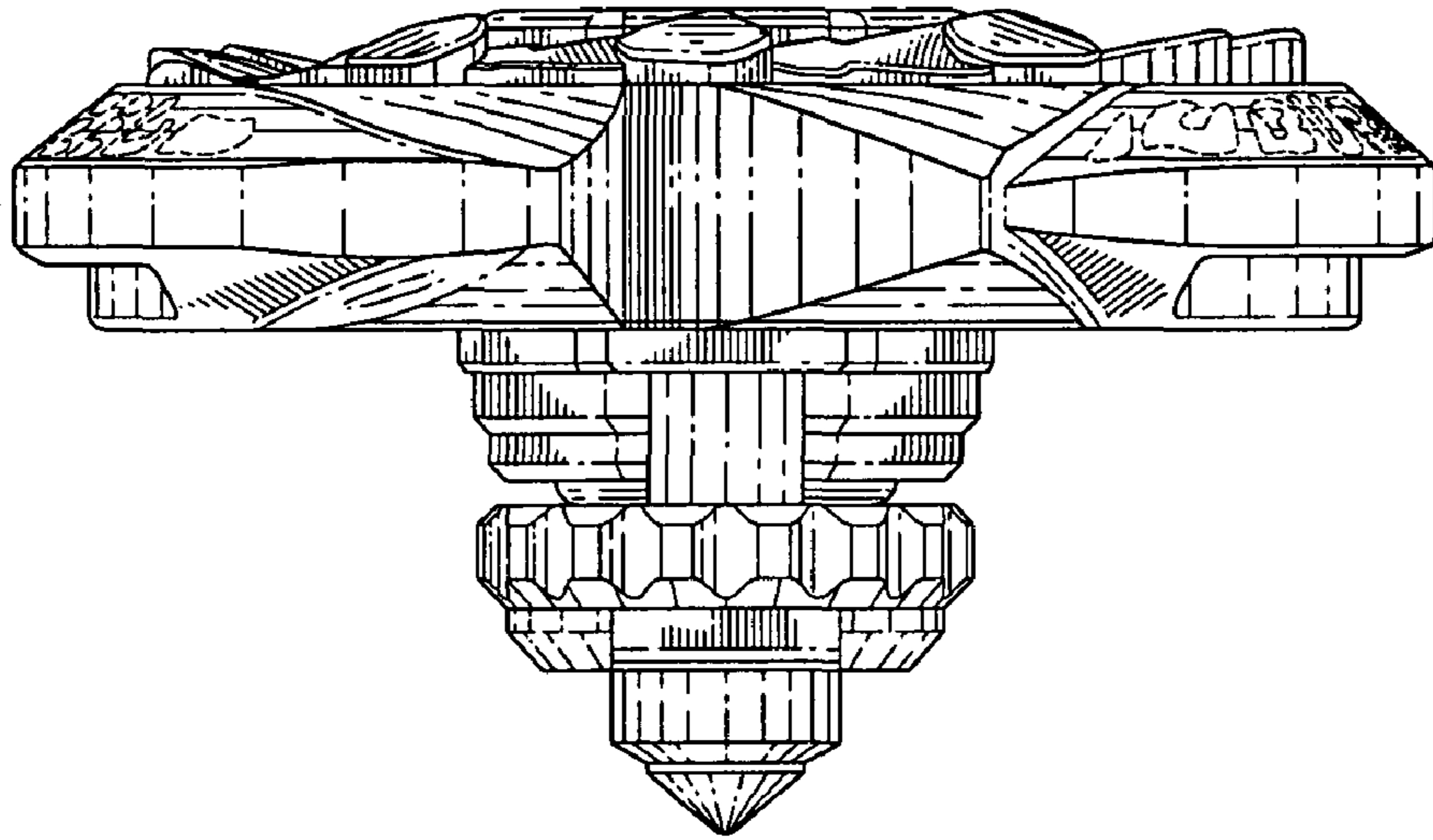

FIG. 10

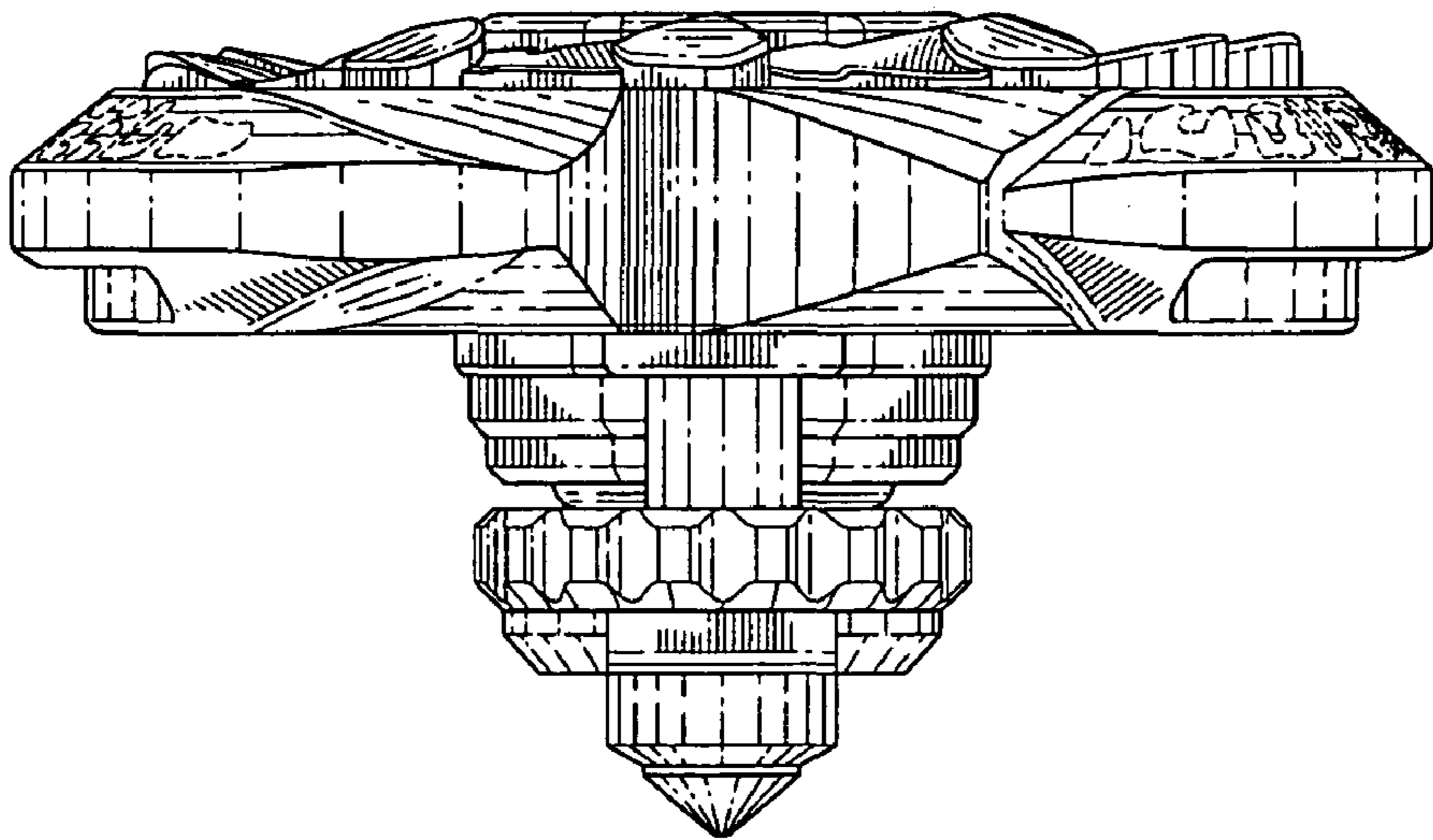

FIG. 11



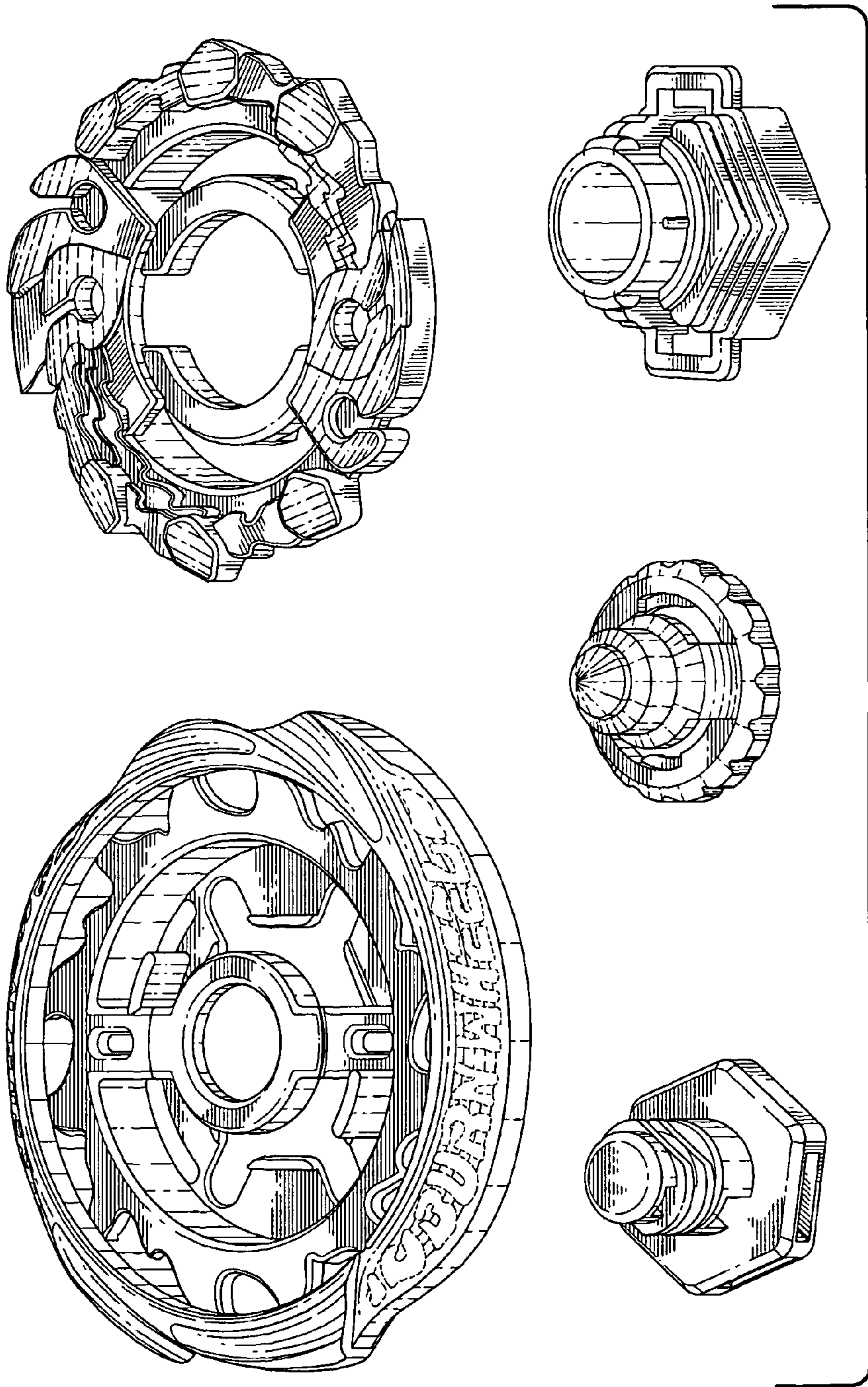

FIG.12