



US00D629407S

(12) **United States Design Patent**  
**Otsuka**

(10) **Patent No.:** **US D629,407 S**  
(45) **Date of Patent:** **\*\* Dec. 21, 2010**

(54) **RECORDING MEDIUM**

**DESCRIPTION**

(75) Inventor: **Hitoshi Otsuka**, Tokyo (JP)  
(73) Assignee: **Kabushiki Kaisha Toshiba**, Tokyo (JP)  
(\*\*) Term: **14 Years**  
(21) Appl. No.: **29/354,820**  
(22) Filed: **Jan. 29, 2010**

(30) **Foreign Application Priority Data**

Nov. 13, 2009 (JP) ..... 2009-026664

(51) **LOC (9) Cl.** ..... **32-00**  
(52) **U.S. Cl.** ..... **D14/480.5**  
(58) **Field of Classification Search** ..... D14/411,  
D14/433, 435.1, 436, 480.1–480.7, 484.1,  
D14/137, 155, 167, 168, 203.1–203.8, 240,  
D14/242, 299; D3/201, 273; D13/107, 108,  
D13/149, 184; 710/300, 301; 439/131, 135–147  
See application file for complete search history.

(56) **References Cited**

**U.S. PATENT DOCUMENTS**

D489,053 S \* 4/2004 Nakamura ..... D14/167

(Continued)

**OTHER PUBLICATIONS**

A-DATA Technology, [online], [retrieved on May 25, 2010].  
Retrieved from the Internet <URL: [http://www.adata.com.tw/en/product\\_show.php?ProductNo=AC96ZZZBK](http://www.adata.com.tw/en/product_show.php?ProductNo=AC96ZZZBK)>.\*

(Continued)

*Primary Examiner*—Cathron C Brooks  
*Assistant Examiner*—Karen E Kearney  
(74) *Attorney, Agent, or Firm*—Banner & Witcoff, Ltd.

(57) **CLAIM**

The ornamental design for a recording medium, as shown and described.

FIG. 1 is a front perspective view of a recording medium, showing my new design;  
FIG. 2 is a front elevational view thereof;  
FIG. 3 is a rear elevational view thereof;  
FIG. 4 is a top plan view thereof;  
FIG. 5 is a bottom plan view thereof;  
FIG. 6 is a right side elevational view thereof; the opposite side being a mirror image thereof;  
FIG. 7 is a front elevational view thereof with a cap in an attached state in use for completeness of illustration;  
FIG. 8 is a rear elevational view of FIG. 7;  
FIG. 9 is a right side elevational view of FIG. 7; the opposite side being a mirror image thereof; a top plan view of FIG. 7 being identical with FIG. 4; a bottom plan view of FIG. 7 being identical with FIG. 5;  
FIG. 10 is a rear perspective view of FIG. 7;  
FIG. 11 is a perspective view thereof with a cap in a removed state for completeness of illustration;  
FIG. 12 is a front elevational view thereof, shown without a cap for completeness of illustration;  
FIG. 13 is a rear elevational view of FIG. 12;  
FIG. 14 is a top plan view of FIG. 12;  
FIG. 15 is a bottom plan view of FIG. 12;  
FIG. 16 is a right side elevational view of FIG. 12; the opposite side being a mirror image thereof;  
FIG. 17 is a front elevational view of the cap thereof for completeness of illustration;  
FIG. 18 is a rear elevational view of FIG. 17;  
FIG. 19 is a bottom plan view of FIG. 17; the opposite side being identical with the FIG. 4; and,  
FIG. 20 is a right side elevational view of FIG. 17; and the opposite side being a mirror image thereof.

**1 Claim, 5 Drawing Sheets**

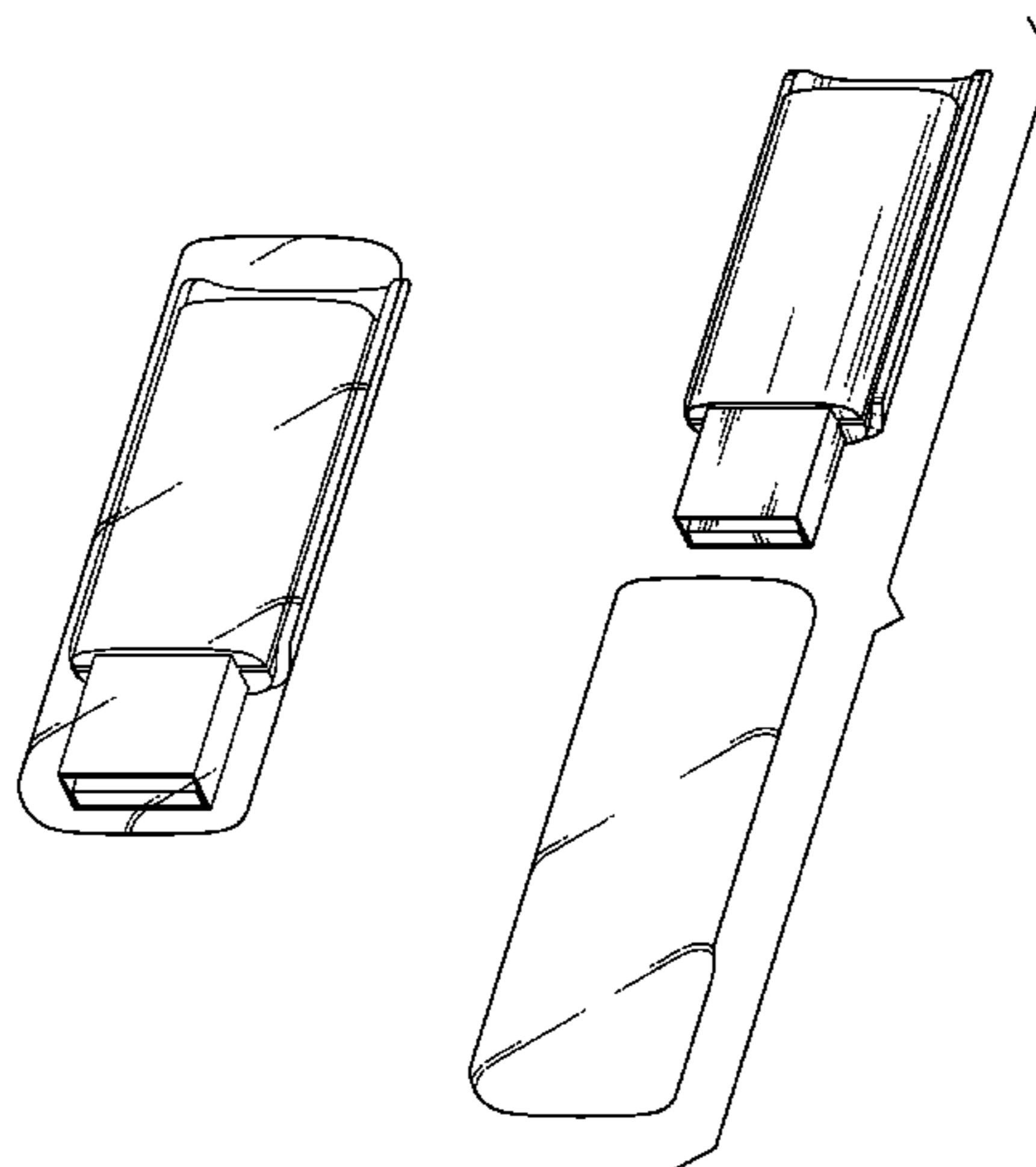

# US D629,407 S

Page 2

---

## U.S. PATENT DOCUMENTS

D524,817 S \* 7/2006 Conley et al. .... D14/480.5  
D537,820 S \* 3/2007 Hsu ..... D14/480.1  
D556,210 S \* 11/2007 Choi et al. .... D14/496  
D556,752 S \* 12/2007 Otsuka ..... D14/356  
D556,762 S \* 12/2007 Hsiau ..... D14/435  
D566,114 S \* 4/2008 Chu ..... D14/356  
D573,577 S \* 7/2008 Huang ..... D14/155  
D585,077 S \* 1/2009 Sheba et al. .... D14/496  
D605,198 S \* 12/2009 Otsuka et al. .... D14/480.5  
D617,331 S \* 6/2010 Lo ..... D14/480.7  
D620,015 S \* 7/2010 Nan et al. .... D14/480.6

D620,946 S \* 8/2010 Lo ..... D14/480.5

## OTHER PUBLICATIONS

Eric Beare Associates Ltd., Flash Memory Stick, [online], [retrieved on Dec. 14, 2006]. Retrieved from the Internet <URL: [http://www.ericbeare.com/public/Theme19/Large\\_Window.asp?page=1&ProductID=A%2D0160](http://www.ericbeare.com/public/Theme19/Large_Window.asp?page=1&ProductID=A%2D0160)>.\*

A-data, Imation, Kingston, Pretec N Toshiba, Web Archive [online] archived on Feb. 8, 2006 [retrieved on Dec. 4, 2006]. Retrieved from the Internet <URL: <http://web.archive.org/web/20060208032439/http://www.ixbt.com/storage/flashdrives-p16.shtml>>.\*

Wealhand Enterprise Co. Ltd. Catalog of Pen Drive (WH-PD 01) received Dec. 6, 2004.

\* cited by examiner

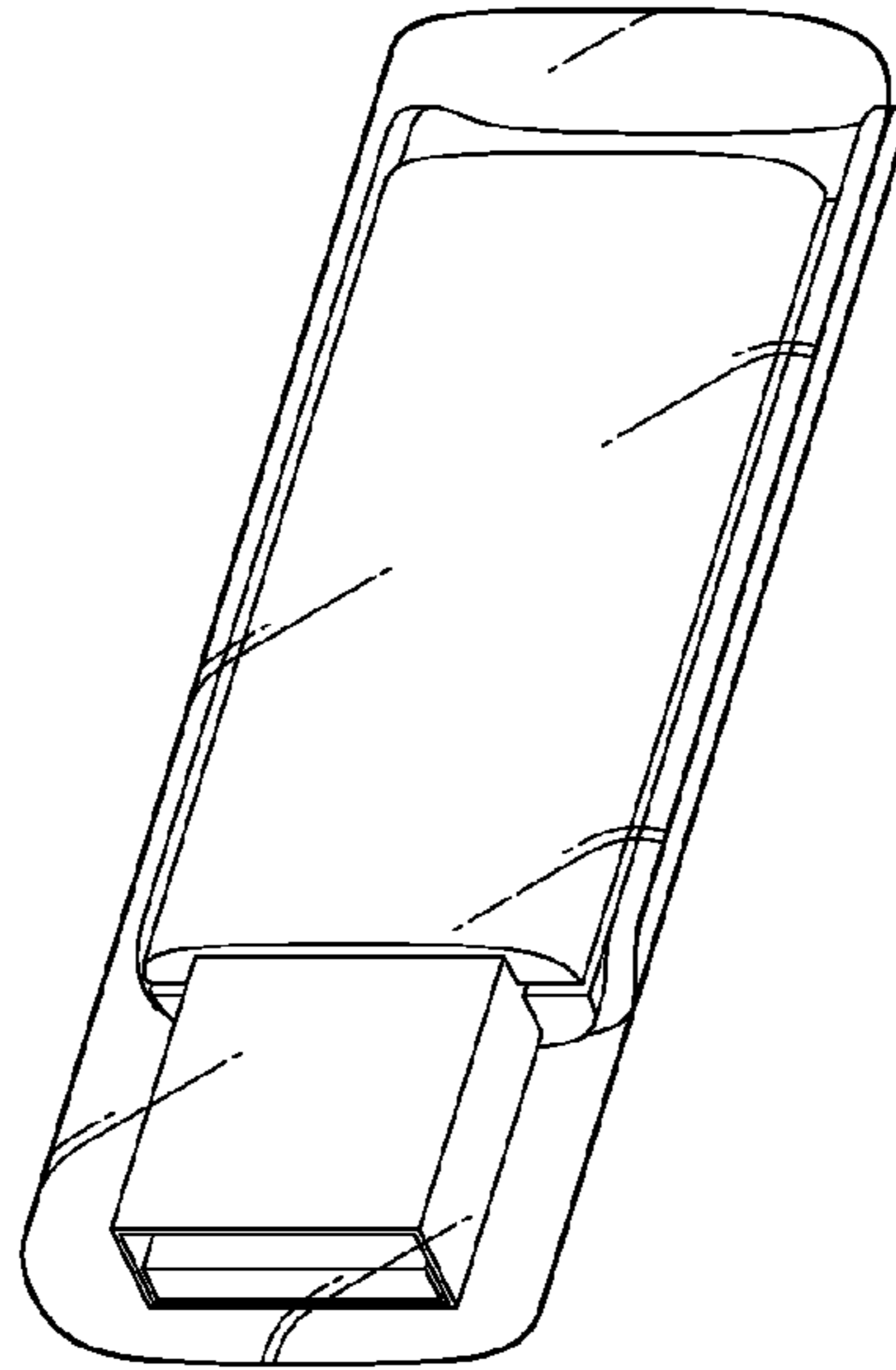

FIG. 1

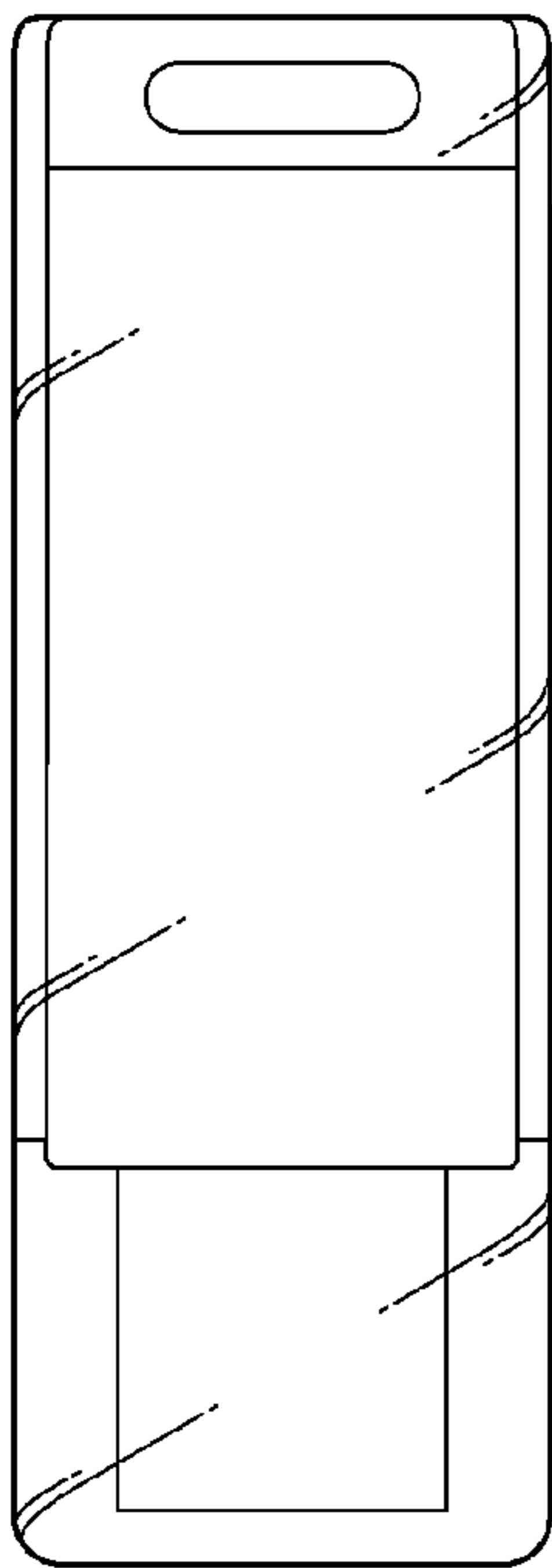

FIG. 2

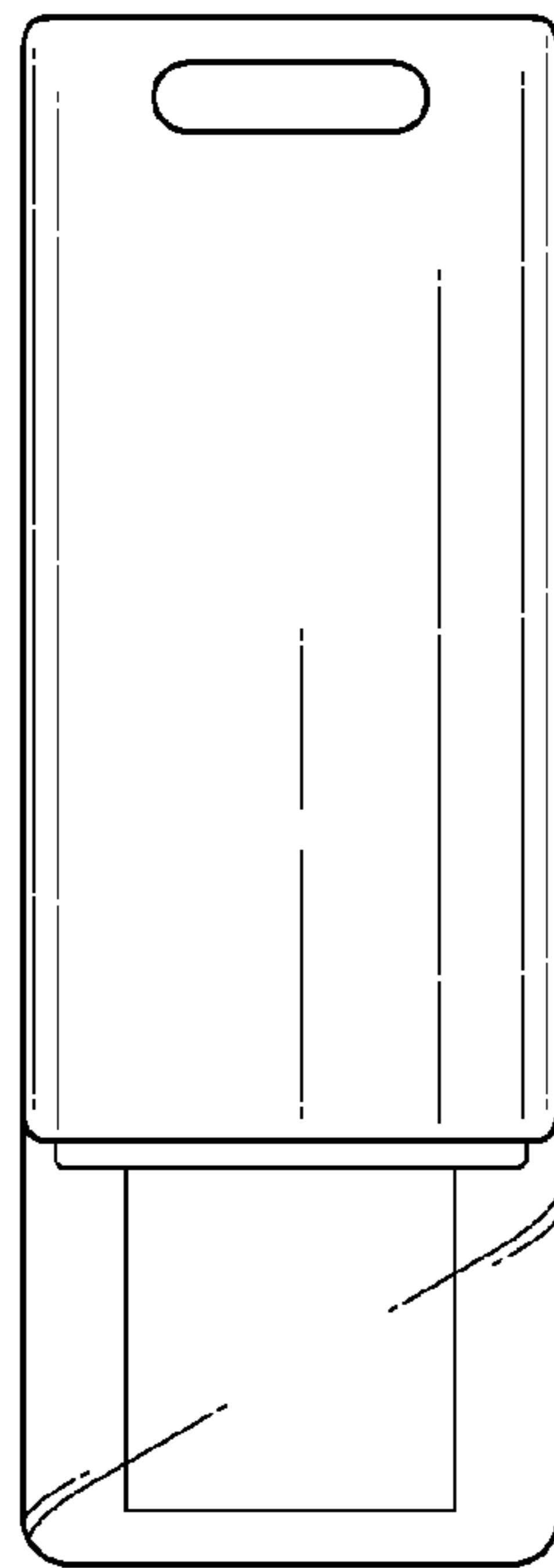

FIG. 3

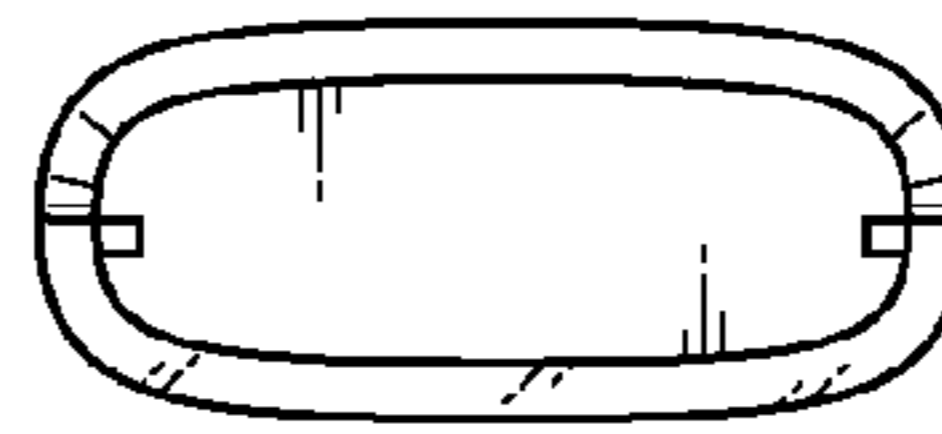

FIG. 4

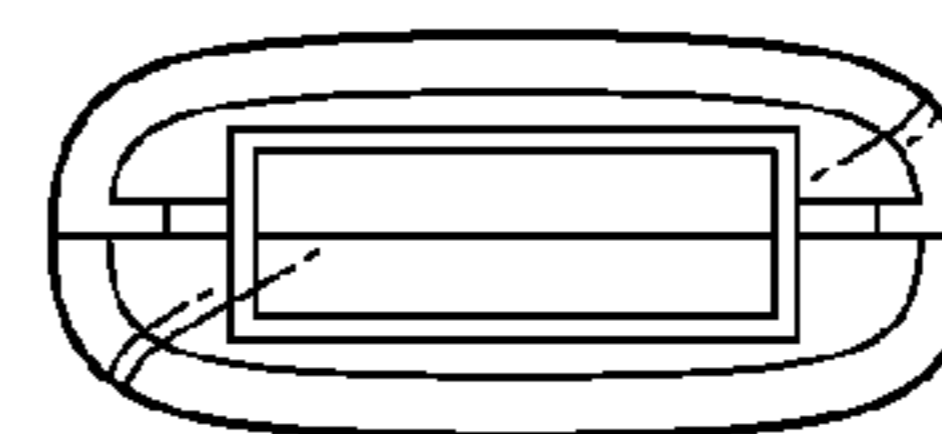

FIG. 5

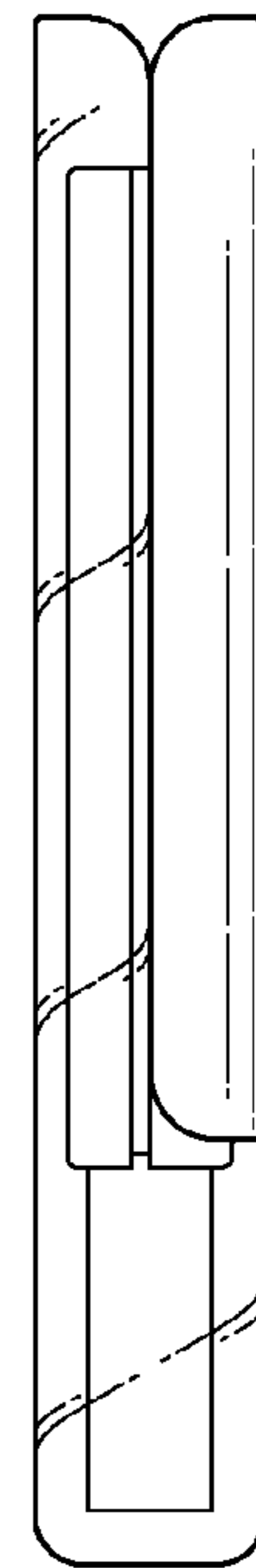

FIG. 6

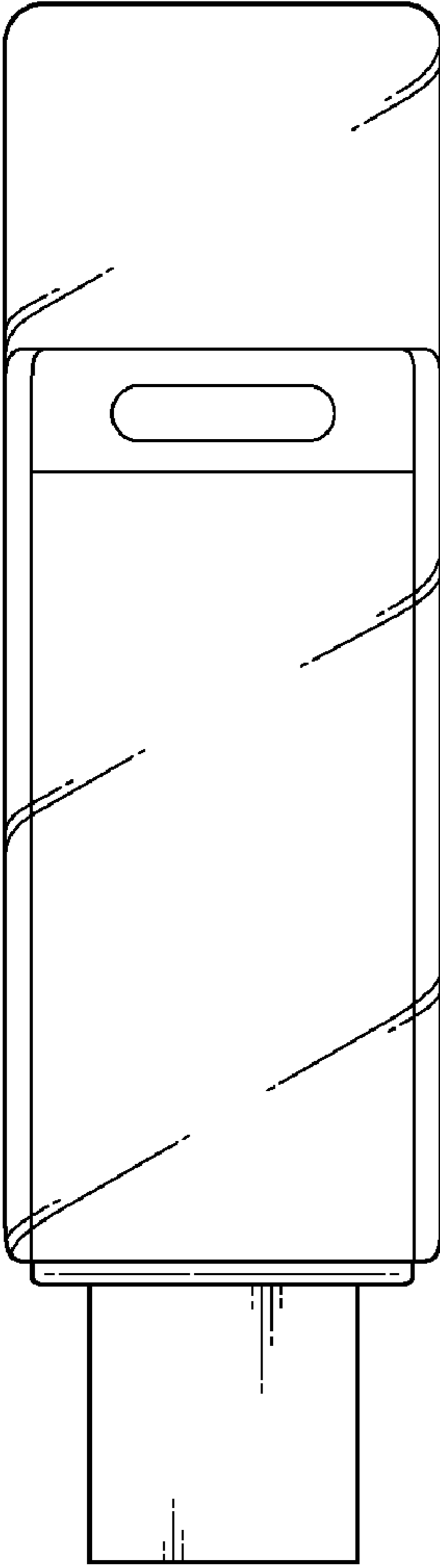

FIG. 7

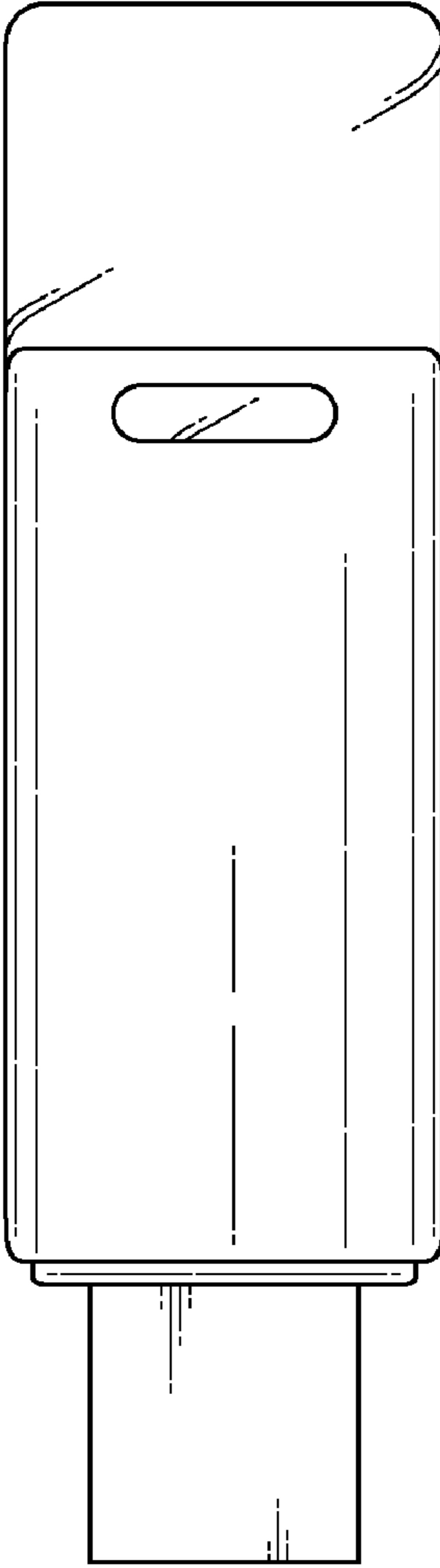

FIG. 8

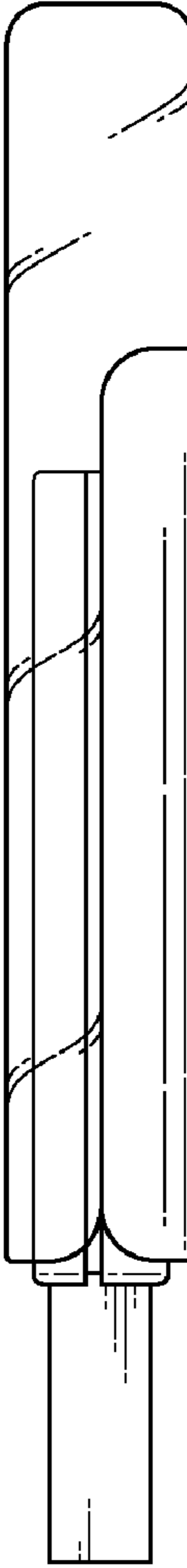

FIG. 9

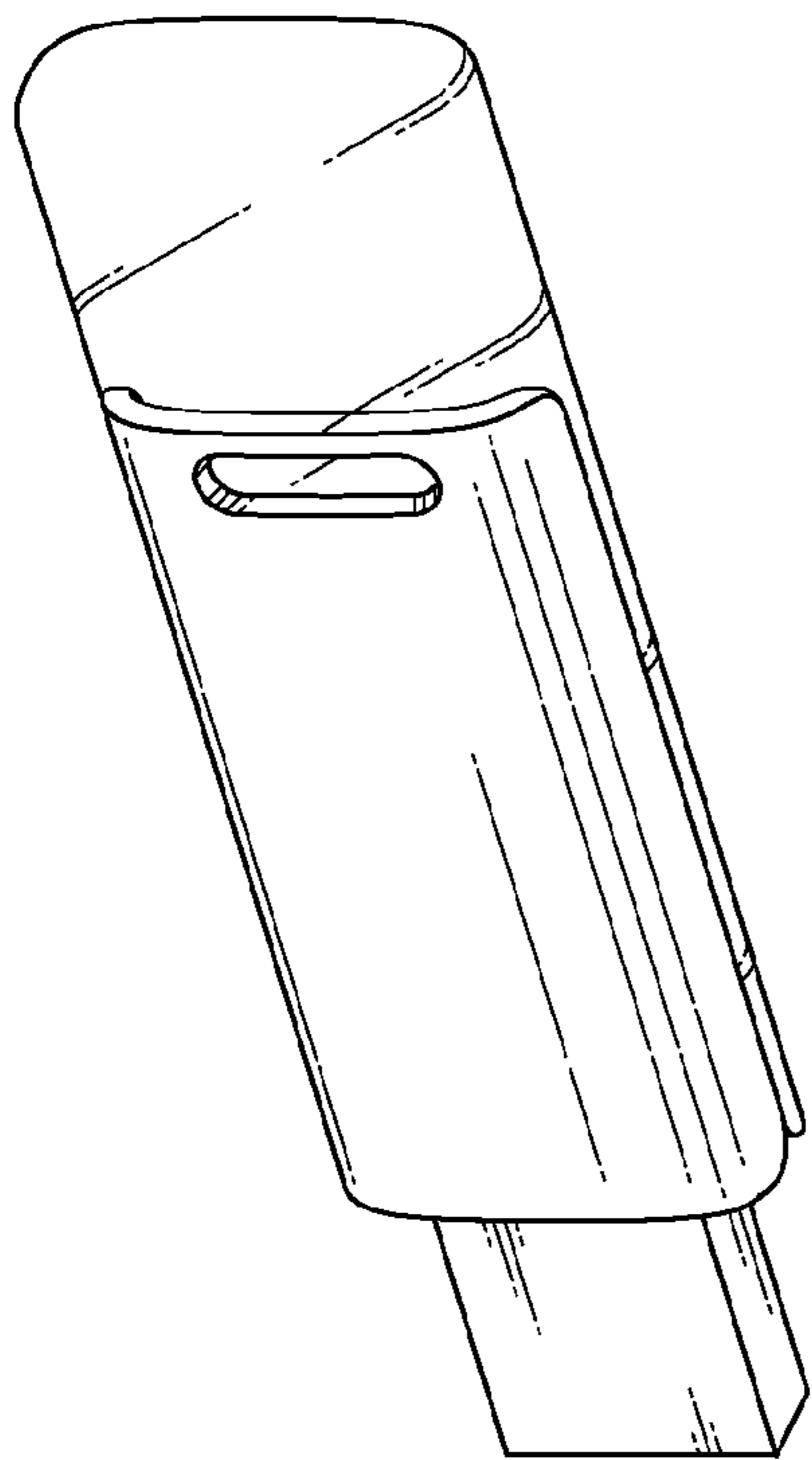

FIG.10

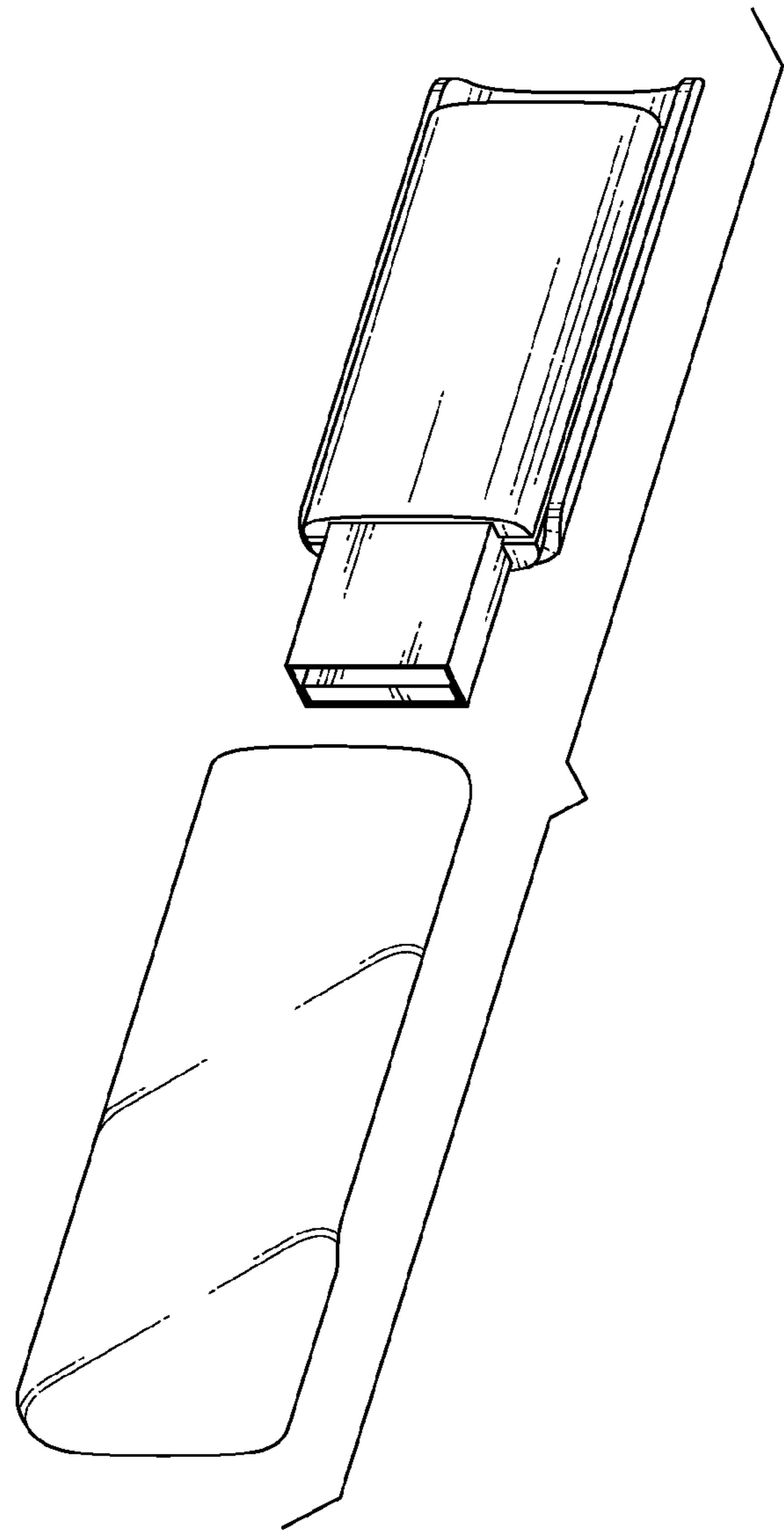

FIG.11

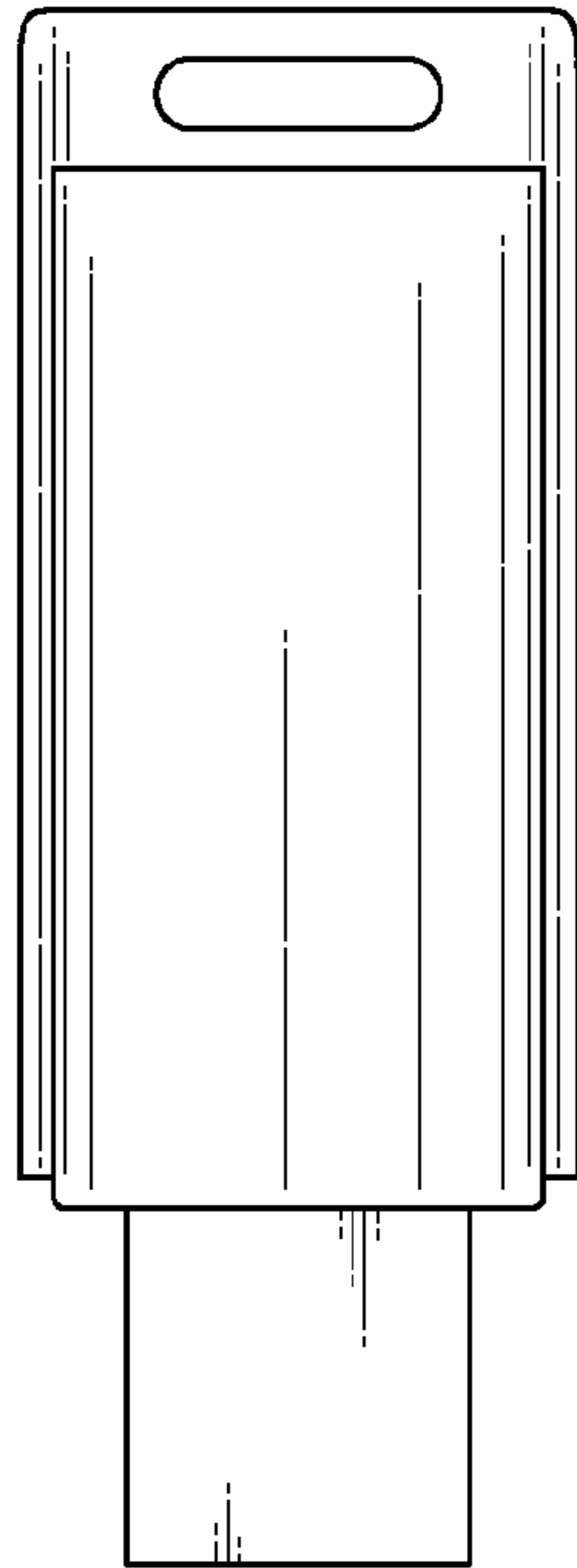

FIG. 12

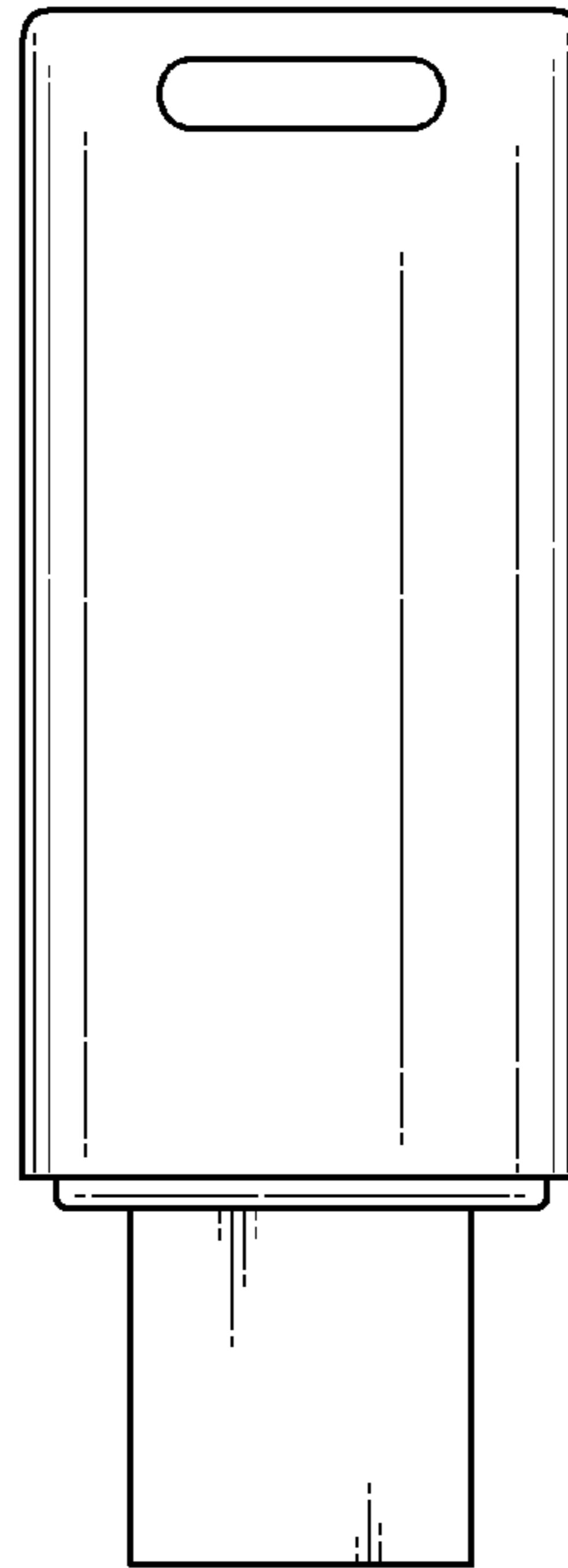

FIG. 13

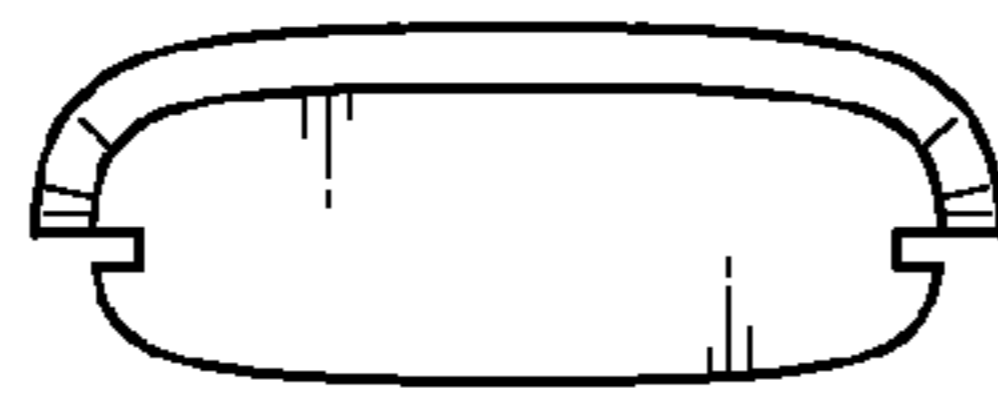

FIG. 14

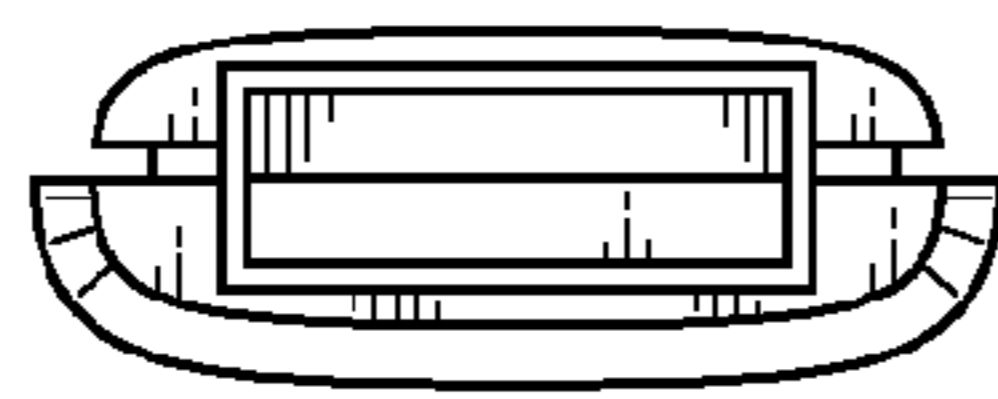

FIG. 15

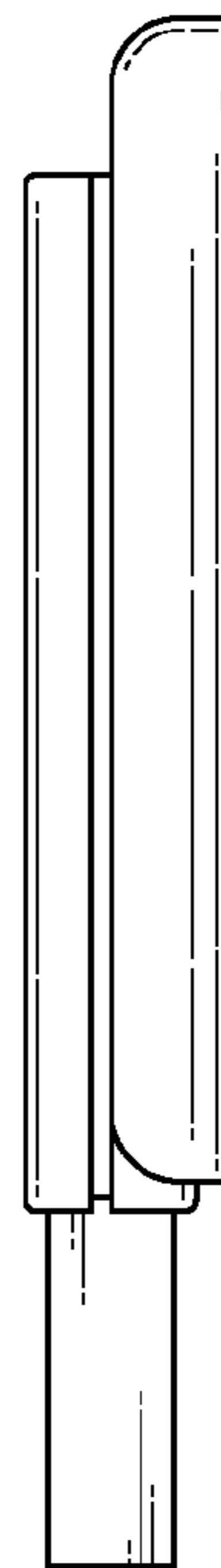

FIG. 16

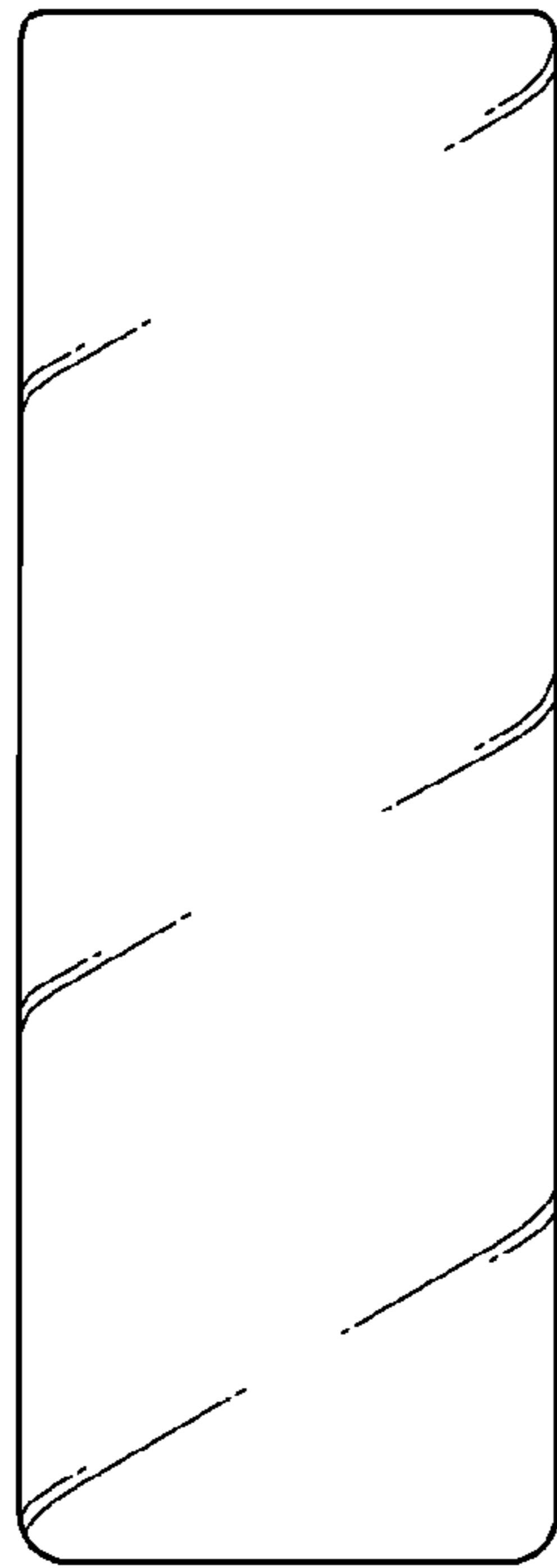

FIG. 17

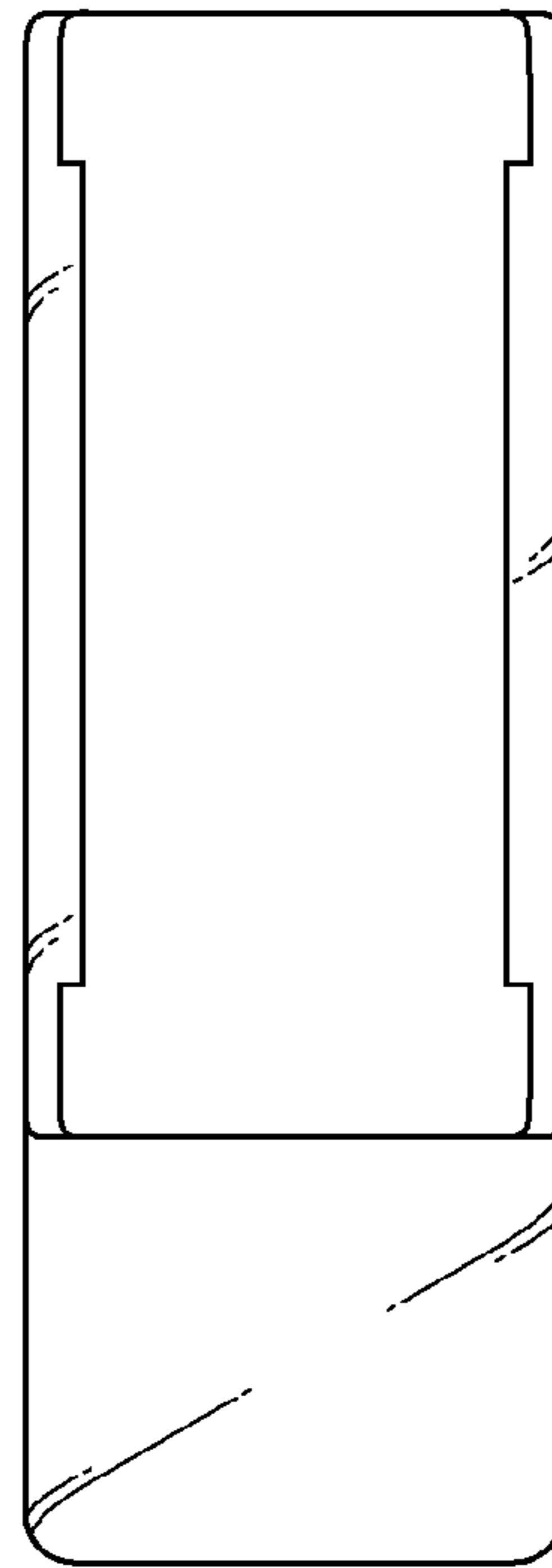

FIG. 18

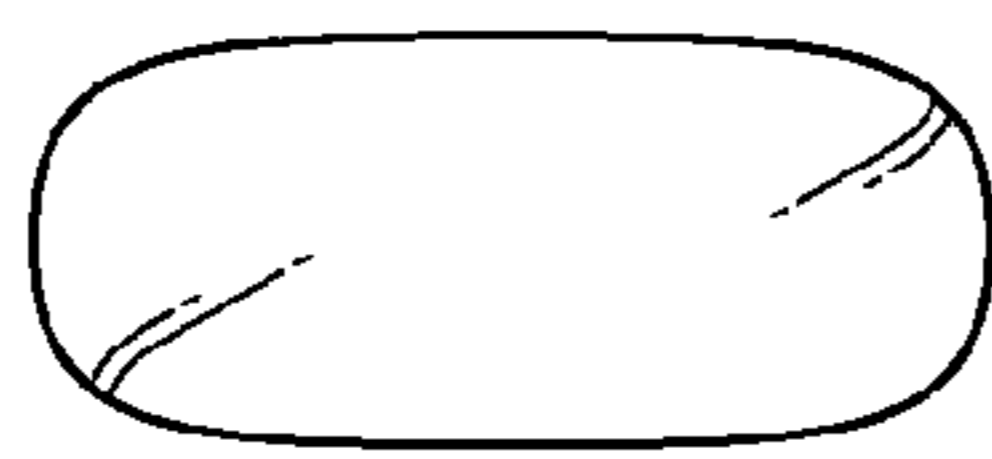

FIG. 19



FIG. 20