



US00D629382S

(12) **United States Design Patent**
Nathan et al.

(10) **Patent No.:** **US D629,382 S**
(45) **Date of Patent:** **** Dec. 21, 2010**

- (54) **JUKEBOX**
- (75) Inventors: **Guy Nathan**, Verdun (CA); **Eric Ferry**, Laval (CA)
- (73) Assignee: **Touchtunes Music Corporation**, Montreal, Quebec (CA)

6,346,951 B1 * 2/2002 Mastronardi 715/716
 6,708,812 B2 3/2004 Greim
 6,714,489 B2 3/2004 Kalis et al.
 D494,188 S 8/2004 Huang
 6,779,904 B1 8/2004 Van Dyk
 D498,558 S 11/2004 Kwok
 7,152,739 B1 12/2006 Burleson

- (**) Term: **14 Years**
- (21) Appl. No.: **29/347,706**
- (22) Filed: **Apr. 15, 2010**

* cited by examiner
Primary Examiner—Prabhakar Deshmukh
 (74) *Attorney, Agent, or Firm*—Nixon & Vanderhye P.C.

Related U.S. Application Data

- (62) Division of application No. 29/300,065, filed on Feb. 15, 2008, now Pat. No. Des. 616,414.

- (51) **LOC (9) Cl.** **14-01**
- (52) **U.S. Cl.** **D14/173; D14/496**
- (58) **Field of Classification Search** D14/496, D14/401, 435, 474, 483, 217, 137, 138, 160, D14/168, 356, 203.1–203.8, 507, 184, 173; 345/156, 169, 173–179, 905; 715/727–729, 715/864; 710/1, 5, 8; 713/1, 600; 455/1.1, 455/1.7, 73, 344–347, 93, 95, 3.01–3.06, 455/550.1, 573.1; 370/342–344; 369/1, 369/2, 6–12; 463/43–47; 273/148 B
 See application file for complete search history.

(56) **References Cited**

U.S. PATENT DOCUMENTS

- D146,175 S * 1/1947 Fuller D14/173
- D146,176 S 1/1947 Fuller
- 4,336,935 A 6/1982 Goldfarb
- D316,858 S * 5/1991 Gobindram D14/143
- D324,240 S 2/1992 Huang
- D328,202 S * 7/1992 Tippit D6/434
- D340,407 S * 10/1993 Rahe et al. D9/665
- 5,630,357 A * 5/1997 Akiyama 99/323.6
- 5,771,778 A 6/1998 MacLean, IV
- 6,079,985 A * 6/2000 Wohl et al. 434/319
- 6,086,380 A * 7/2000 Chu et al. 434/307 A

(57) **CLAIM**

The ornamental design for a jukebox, as shown and described.

DESCRIPTION

FIG. 1 is a front perspective view of a jukebox showing our new design;
 FIG. 2 is a front elevation view thereof;
 FIG. 3 is a rear elevation view thereof;
 FIG. 4 is a top plan view thereof;
 FIG. 5 is a bottom plan view thereof;
 FIG. 6 is a right side view thereof, the left side view being a mirror image thereof; and,
 FIG. 7 is a rear perspective view thereof.

The dashed lines shown in FIGS. 1-7 represent environmental structure and form no part of the claimed design. Some views of the jukebox portions are not shown and represent unclaimed subject matter.

Applicant reserves the right to claim the various elements shown in the Figures and described herein in any combination, any sub-combination, and/or any combinations of sub-combinations. For example, Applicant reserves the right to claim the jukebox, speaker panel, speaker array, display face, frames, or the like, shown in the Figures and described herein together, in any sub-combination, and/or in any combination of sub-combinations.

1 Claim, 6 Drawing Sheets

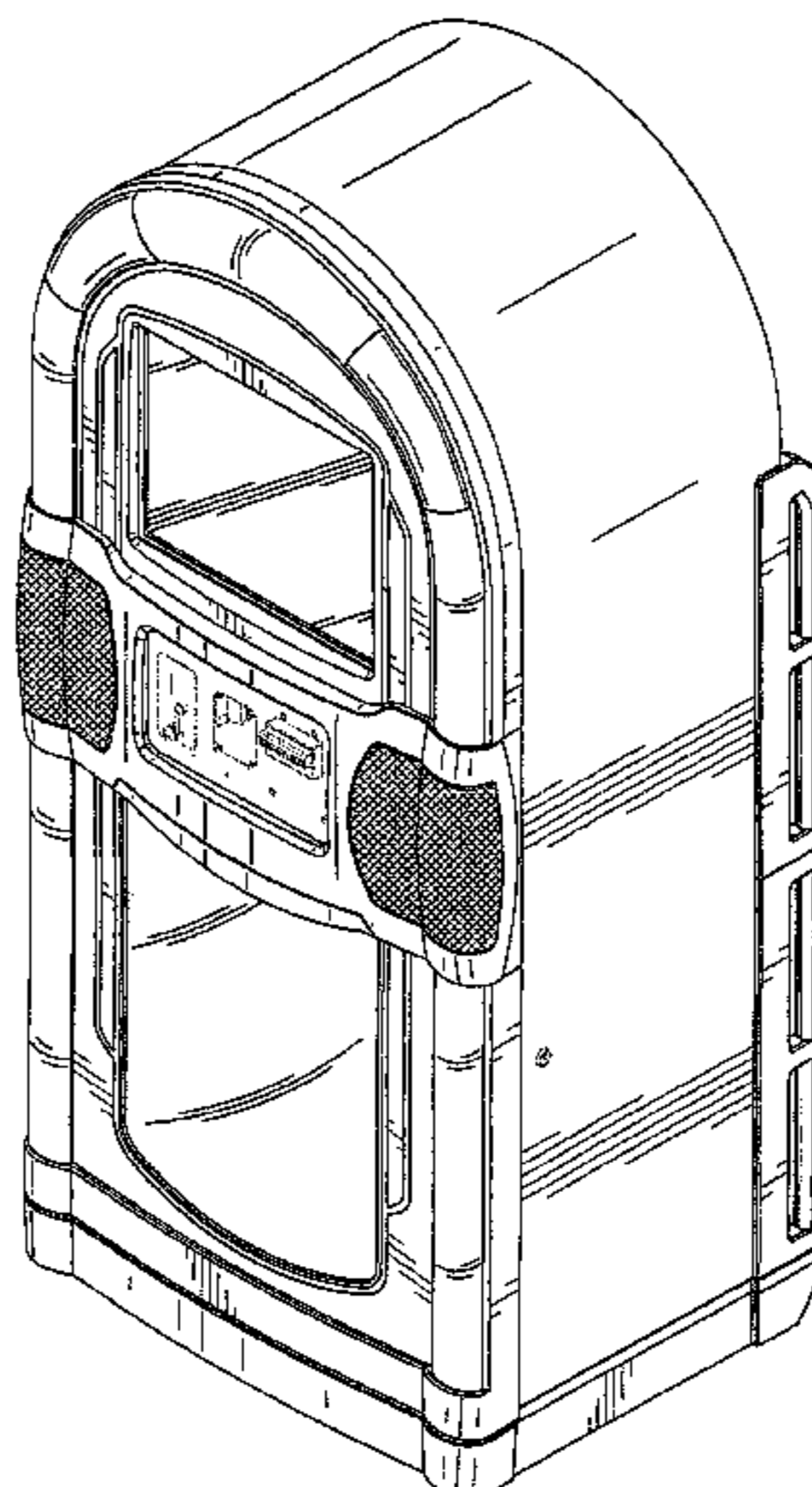

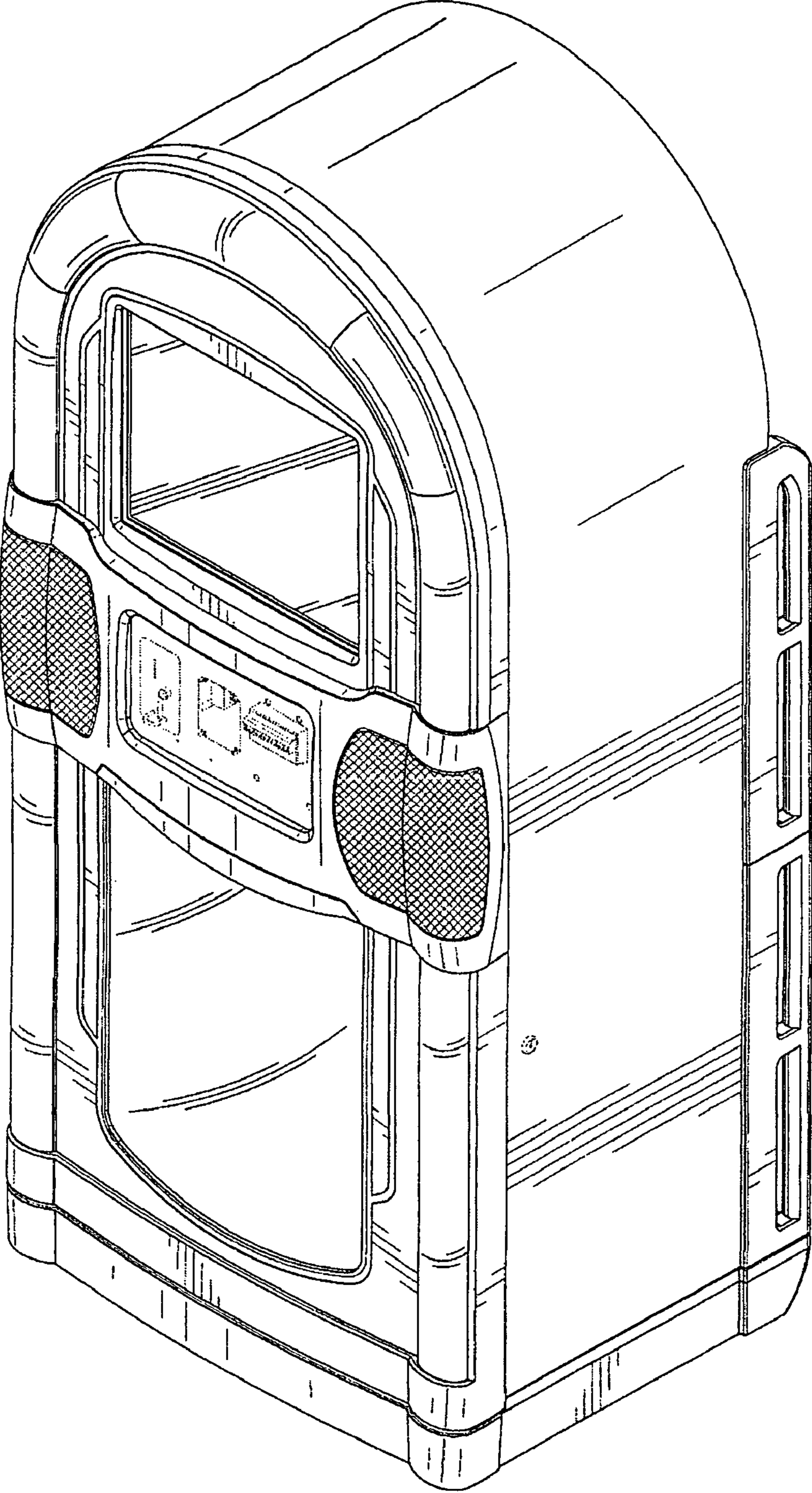

Fig. 1

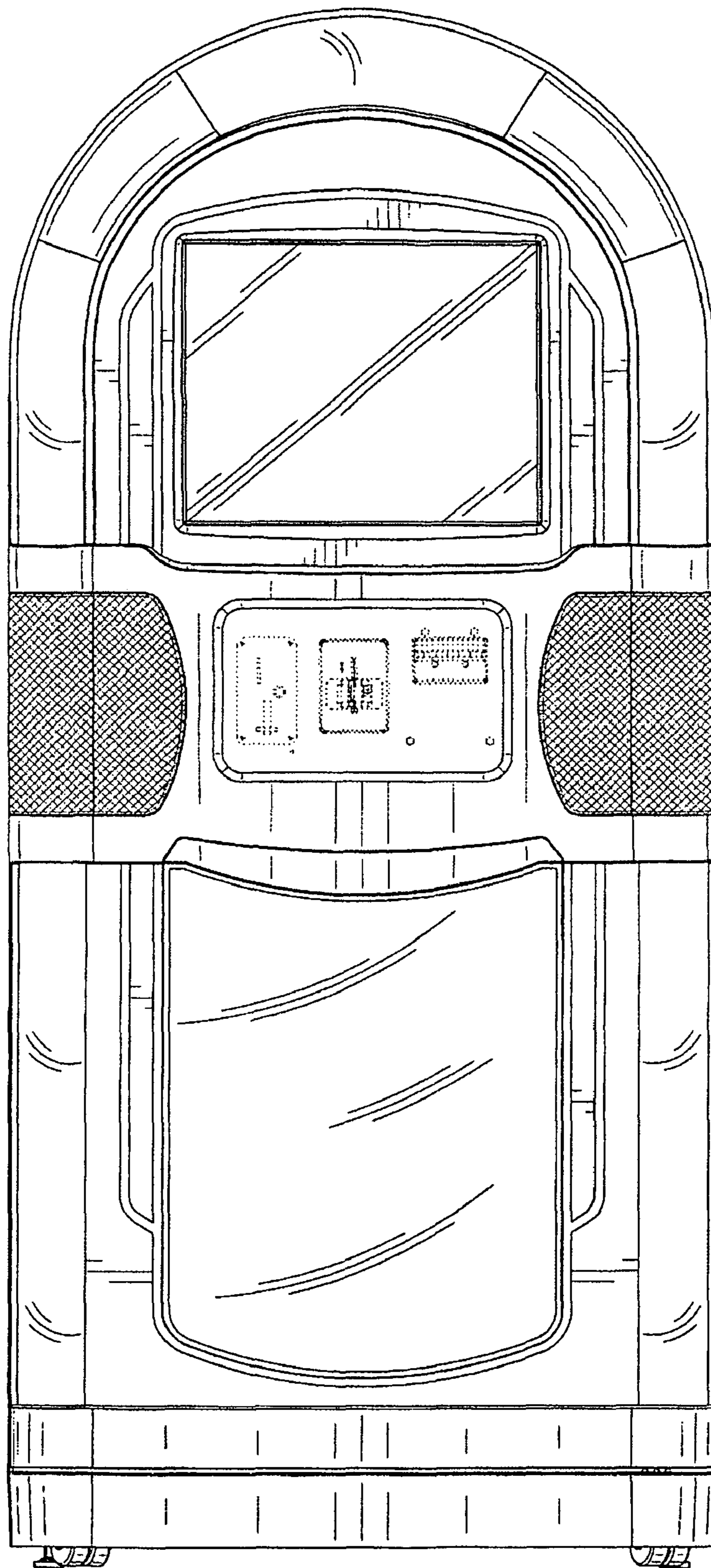

Fig. 2

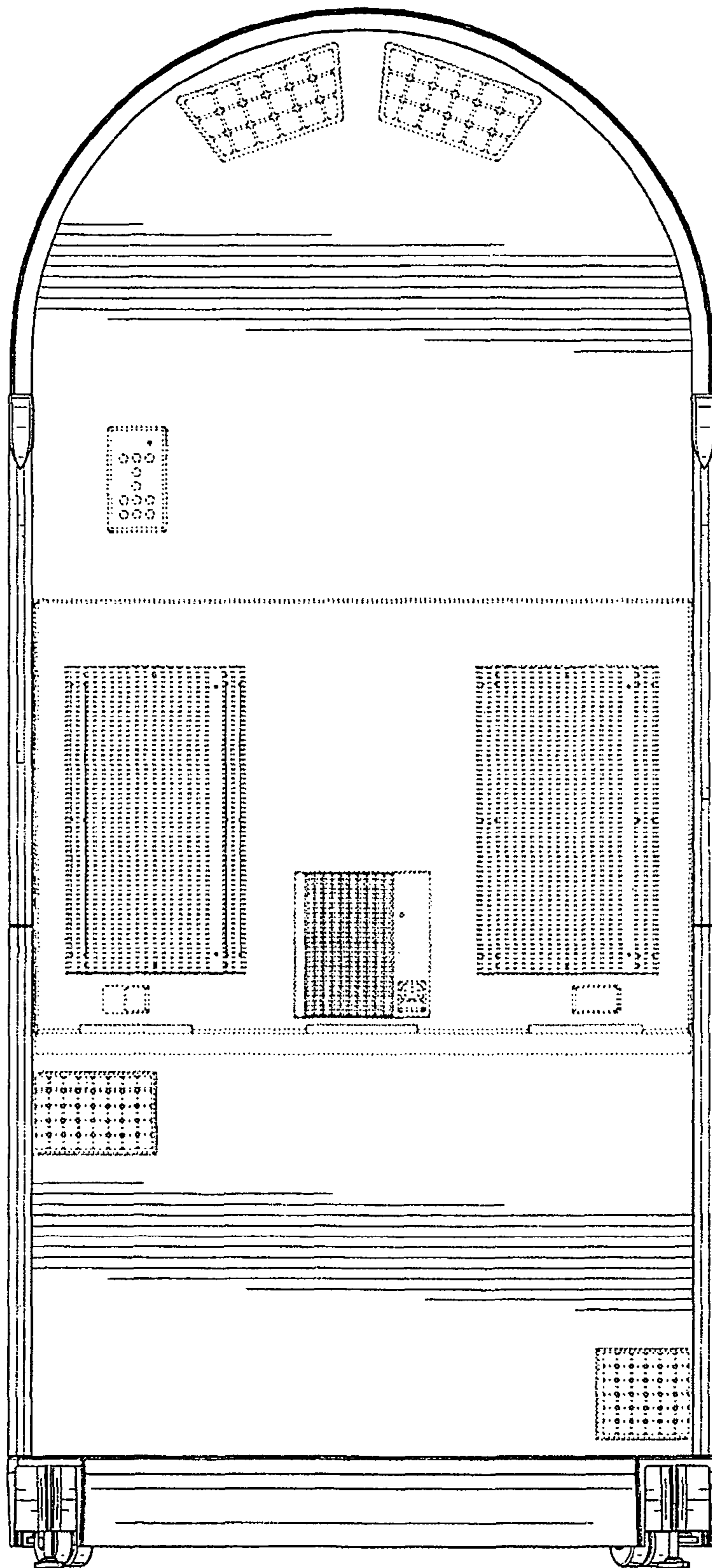

Fig. 3

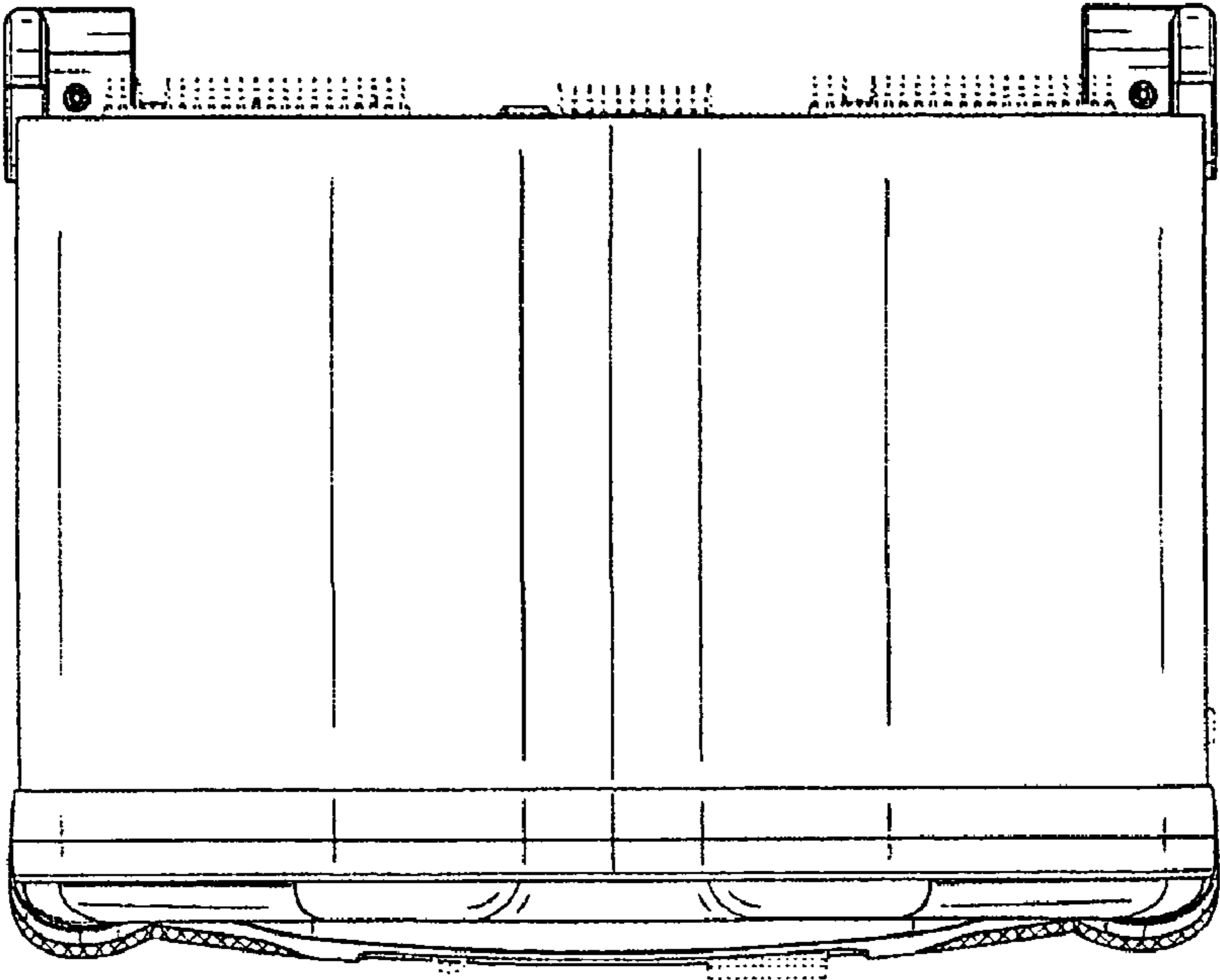

Fig. 4

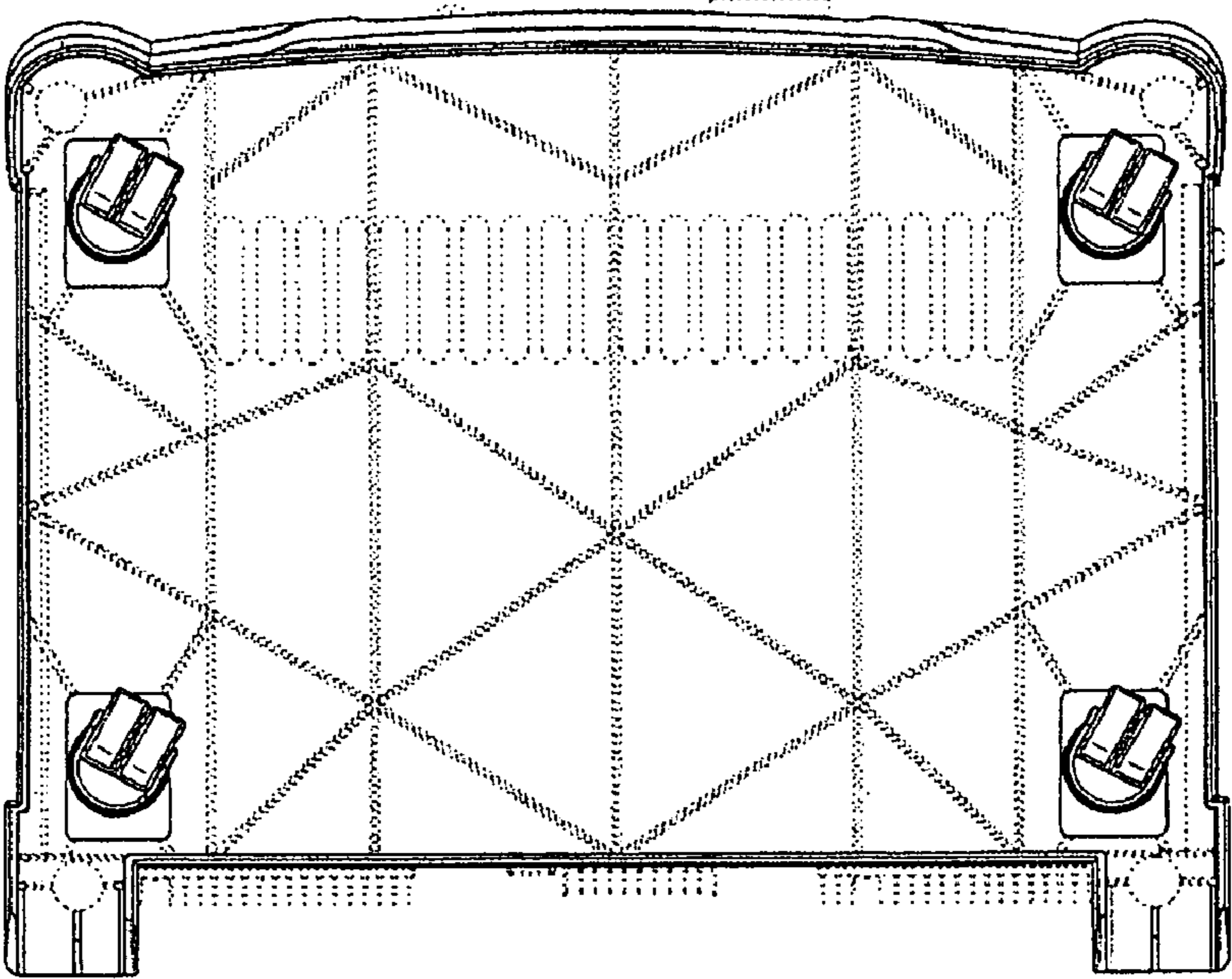

Fig. 5

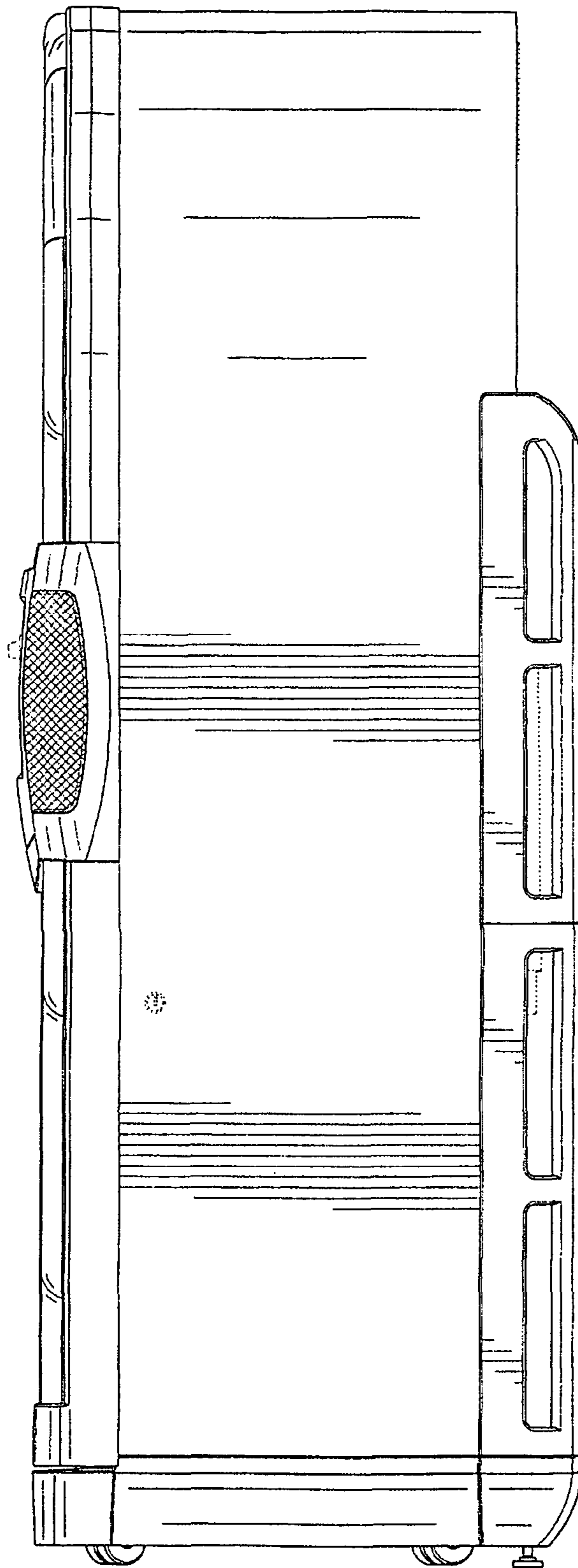

Fig. 6

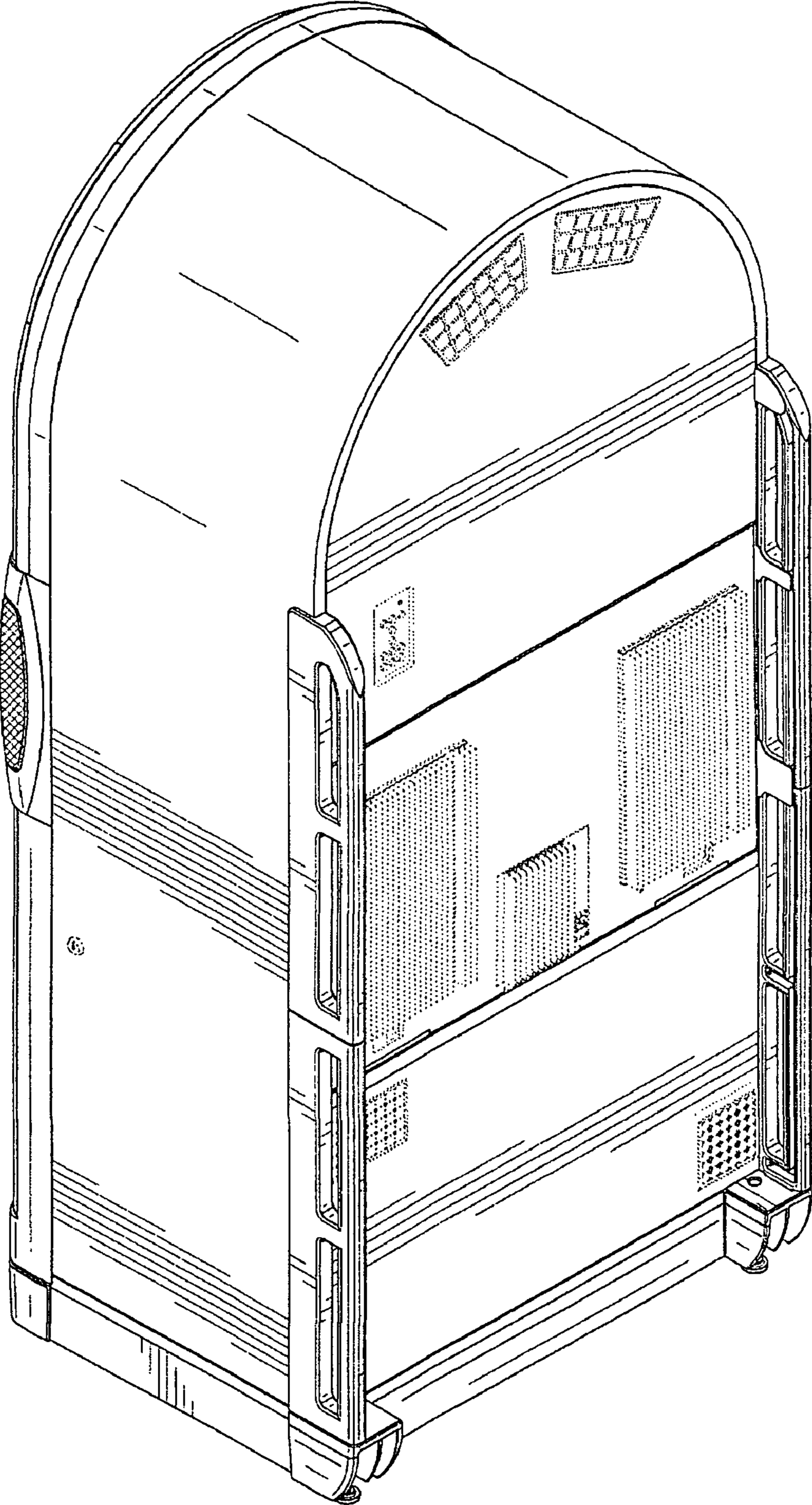

Fig. 7