



US00D629367S

(12) **United States Design Patent**
Detemple et al.

(10) **Patent No.:** **US D629,367 S**

(45) **Date of Patent:** **** Dec. 21, 2010**

(54) **CIRCUIT BREAKER FOR LOW VOLTAGE SWITCHING DEVICES**

(75) Inventors: **Thomas Detemple**, Planegg (DE); **Peter Trautwein**, Munich (DE)

(73) Assignee: **Siemens Aktiengesellschaft**, Munich (DE)

(**) Term: **14 Years**

(21) Appl. No.: **29/358,843**

(22) Filed: **Apr. 1, 2010**

(30) **Foreign Application Priority Data**

Oct. 2, 2009 (EM) 001168561

(51) **LOC (9) Cl.** **13-03**

(52) **U.S. Cl.** **D13/160**

(58) **Field of Classification Search** D13/158, D13/159, 160, 162, 184, 199; 200/43.14, 200/50.01, 50.21-50.23, 51 R, 293; 361/42, 361/44, 50, 71, 115, 608, 634
See application file for complete search history.

(56) **References Cited**

U.S. PATENT DOCUMENTS

D406,106 S * 2/1999 Gonser D13/160
D498,464 S * 11/2004 Kim D13/160
D580,880 S * 11/2008 Lifran D13/160

FOREIGN PATENT DOCUMENTS

WO DM069980 3/2008

OTHER PUBLICATIONS

Notification of Reason for Refusal for Japanese design patent application No. 2010-008316 dated Oct. 5, 2010 (in English).

* cited by examiner

Primary Examiner—Daniel D Bui

Assistant Examiner—Thomas J Johannes

(74) *Attorney, Agent, or Firm*—Harness, Dickey & Pierce, P.L.C.

(57) **CLAIM**

The ornamental design for a circuit breaker for low voltage switching devices, as shown and described.

DESCRIPTION

FIG. 1 is a front view of a circuit breaker for low voltage switching devices showing our new design;

FIG. 2 is a rear view thereof;

FIG. 3 is a top view thereof;

FIG. 4 is a bottom view thereof;

FIG. 5 is a left side view thereof;

FIG. 6 is a right side view thereof; and,

FIG. 7 is a perspective view thereof.

The broken line portion of the figure drawings is included to show unclaimed subject matter only and forms no part of the claimed design.

1 Claim, 7 Drawing Sheets

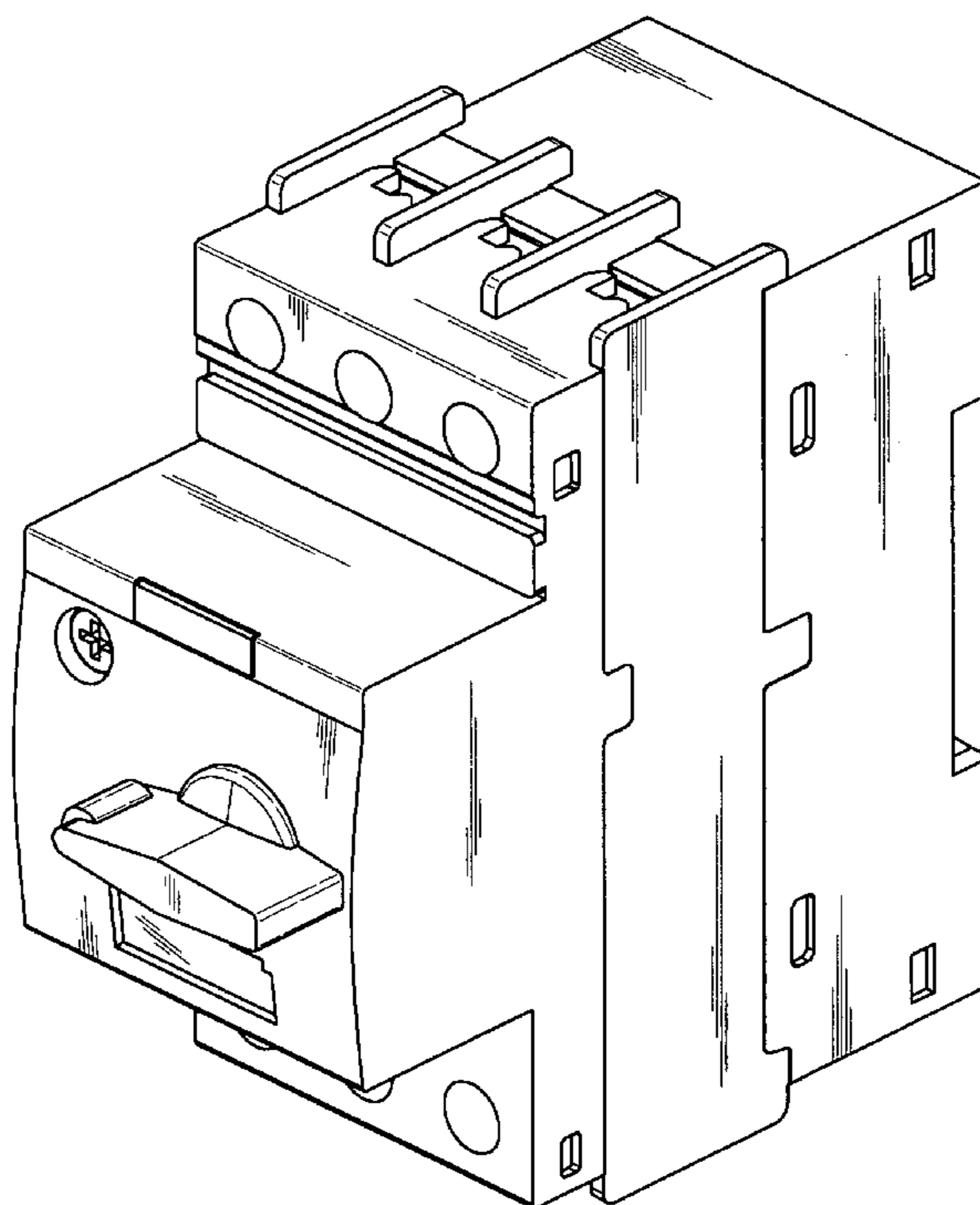

FIG 1

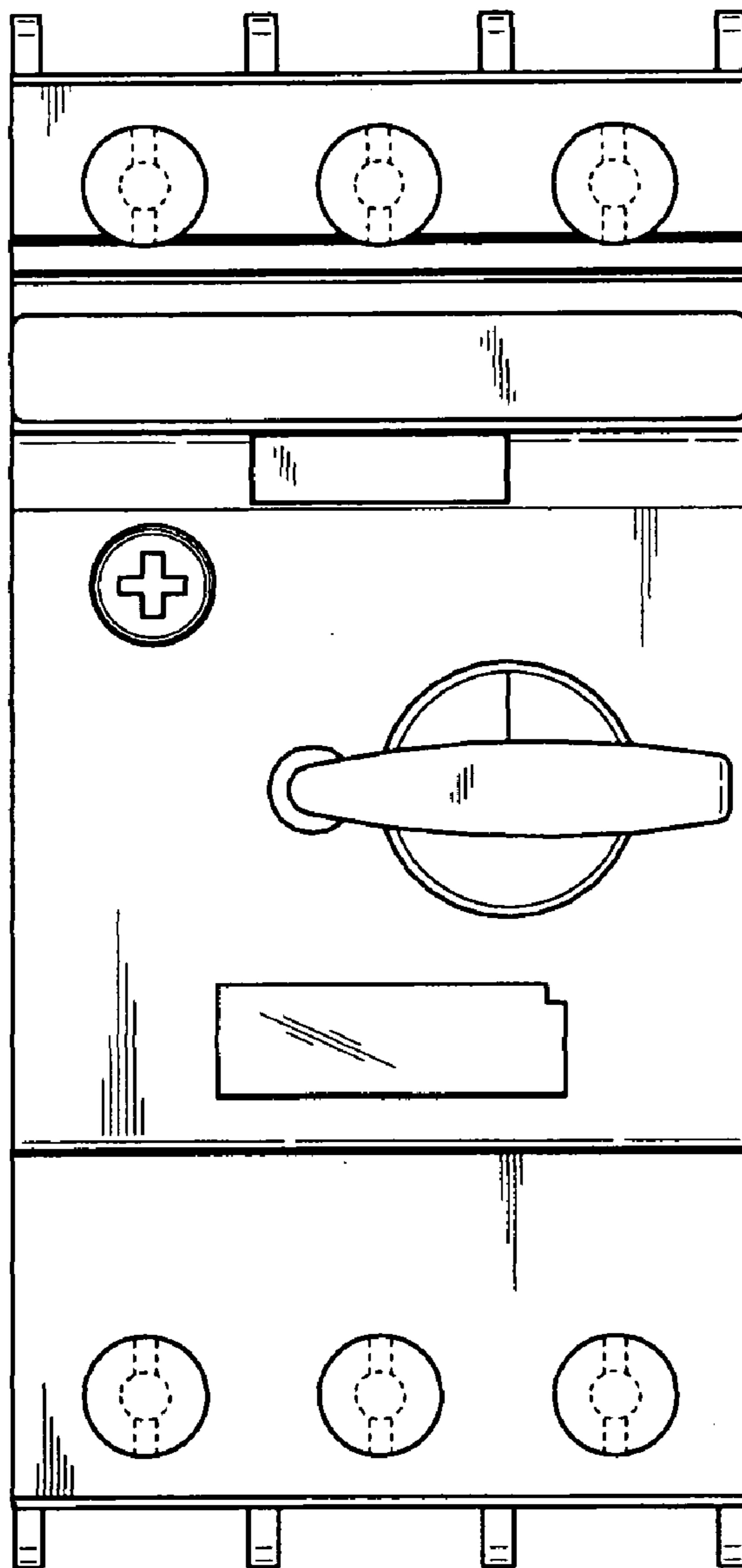

FIG 2

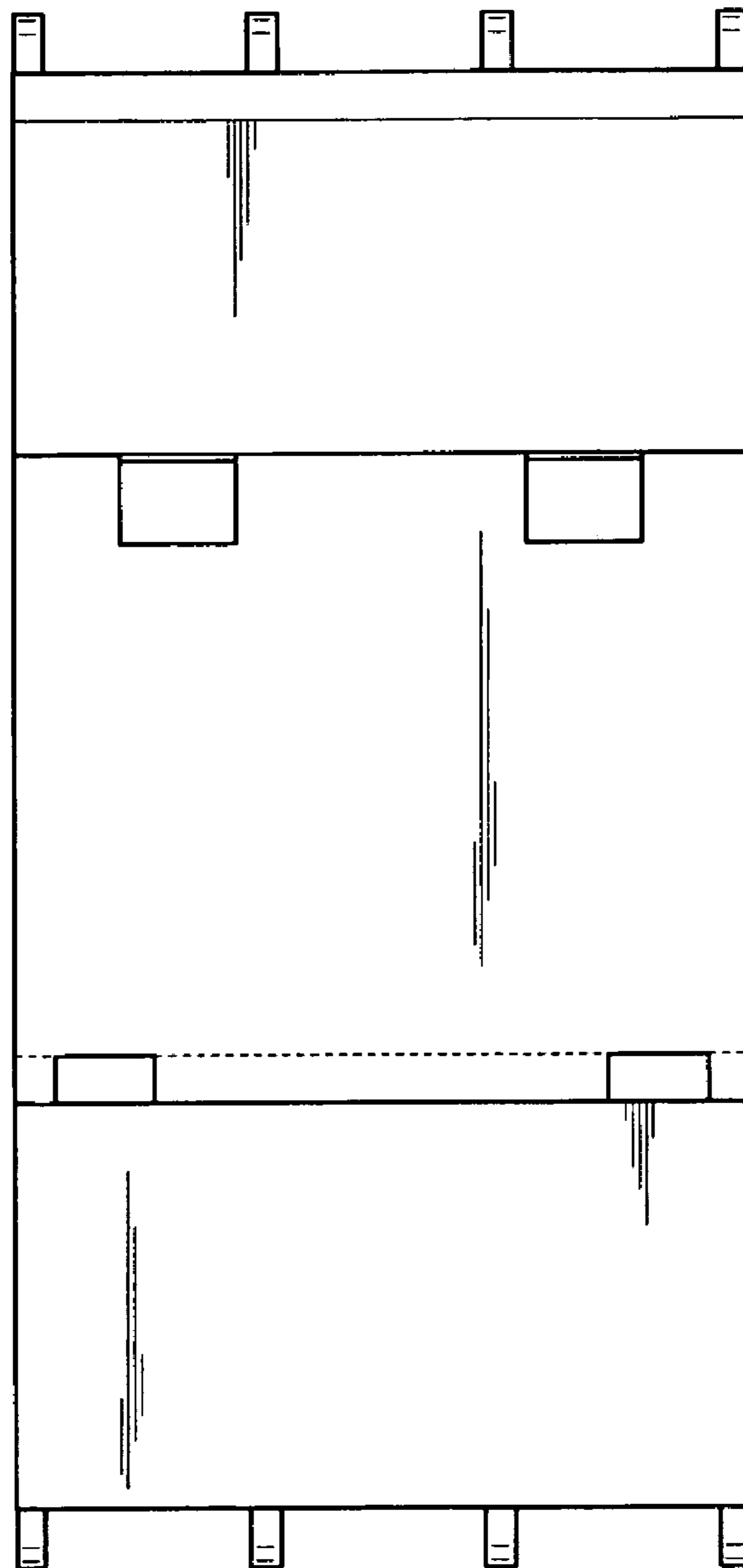

FIG 3

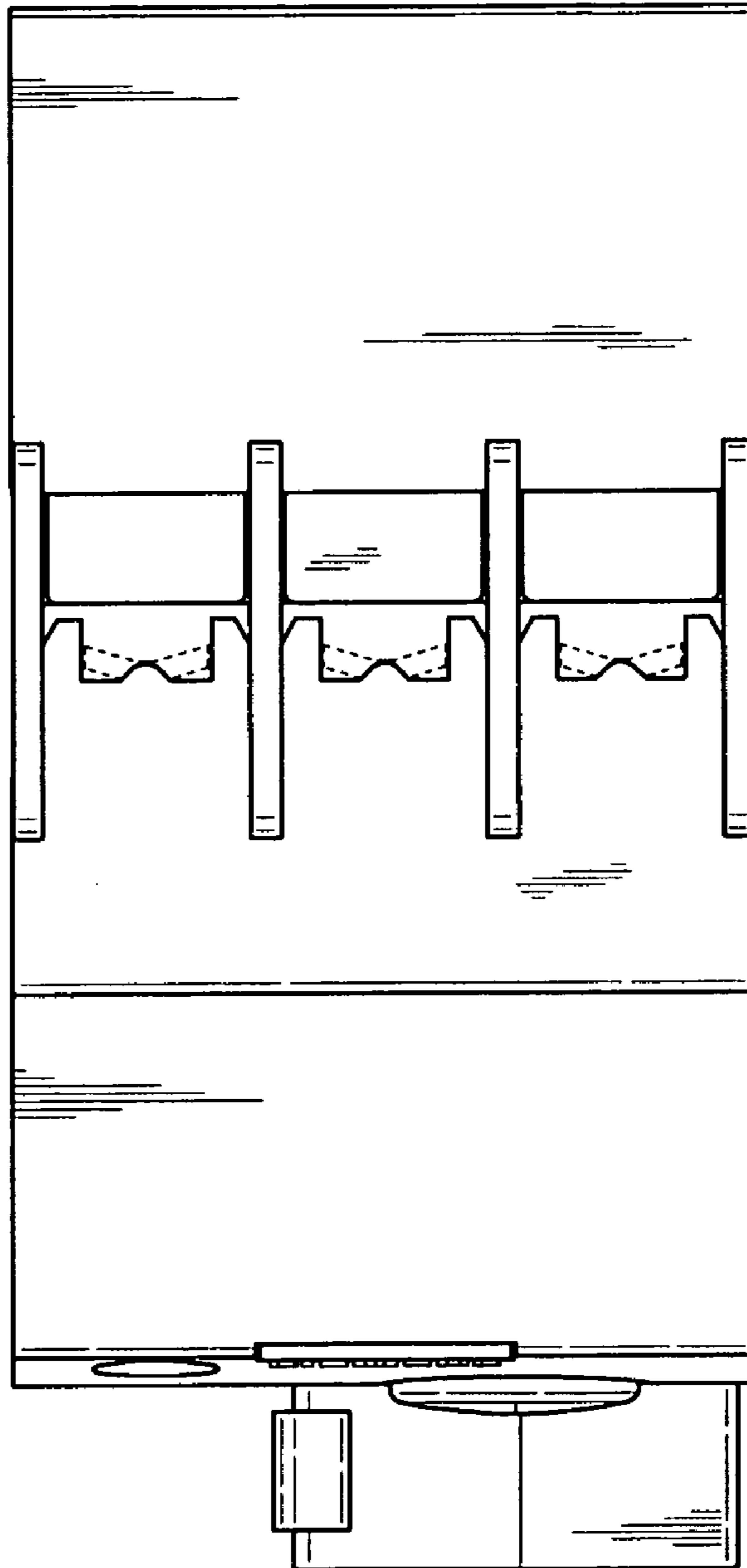

FIG 4

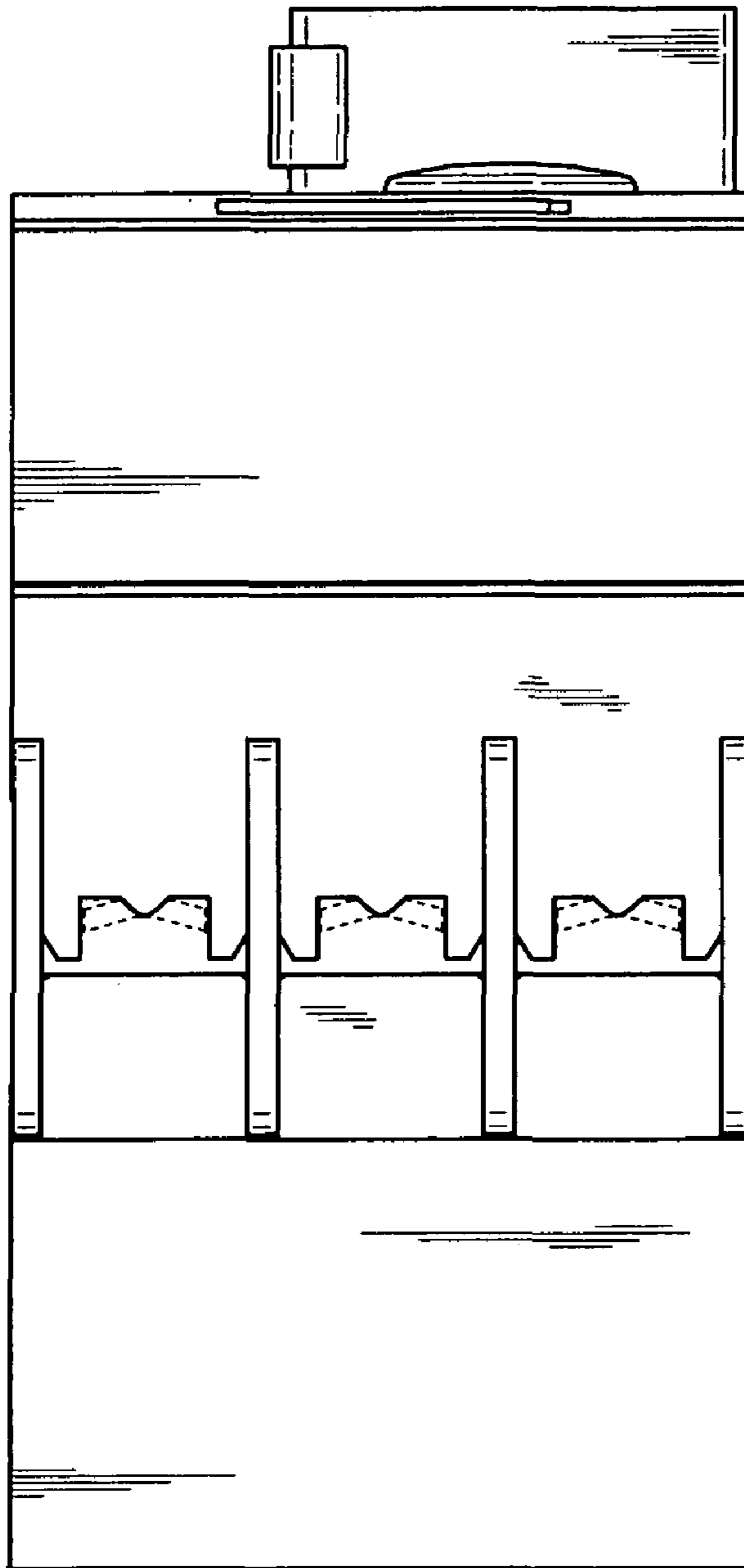

FIG 5

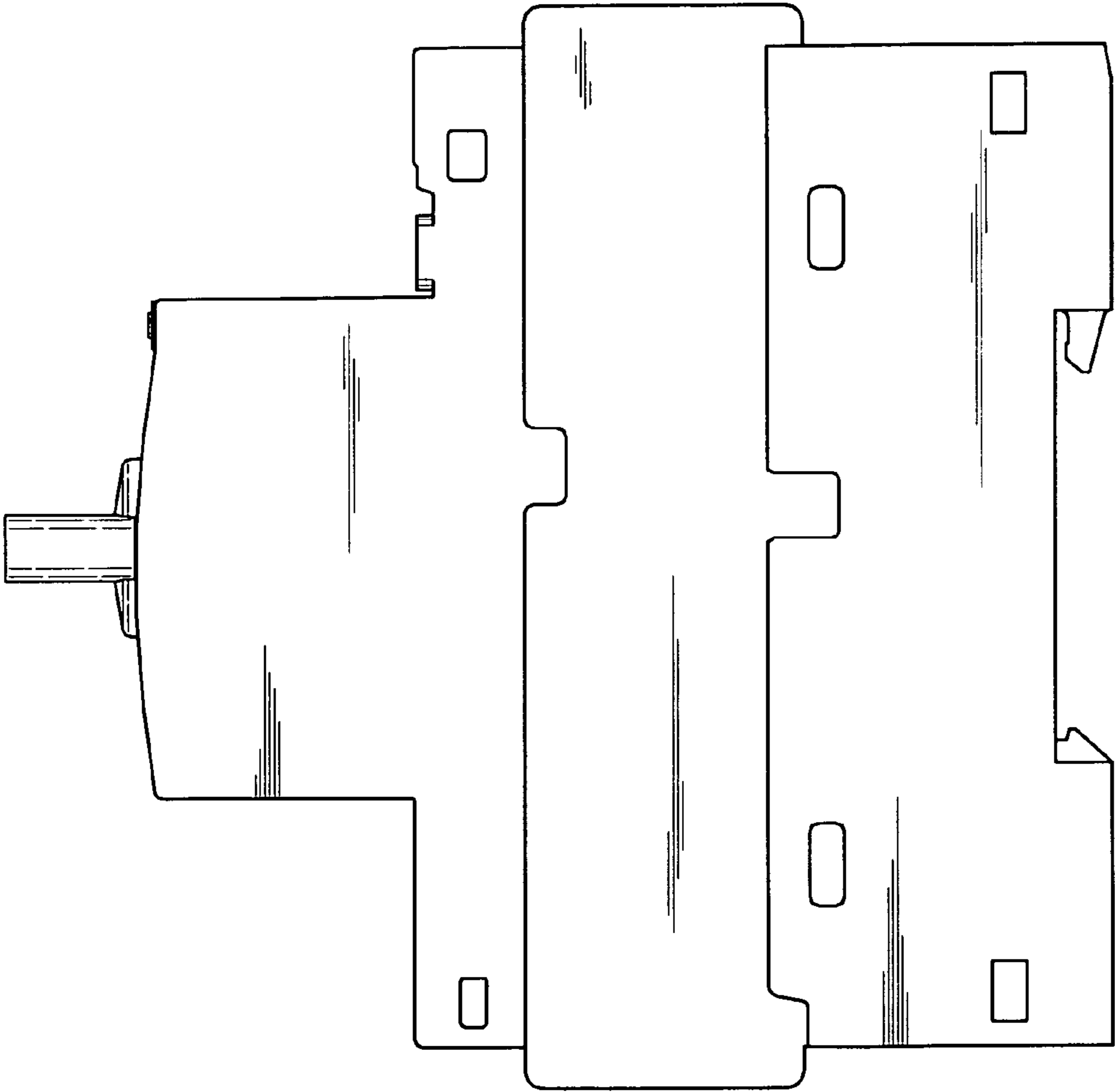

FIG 6

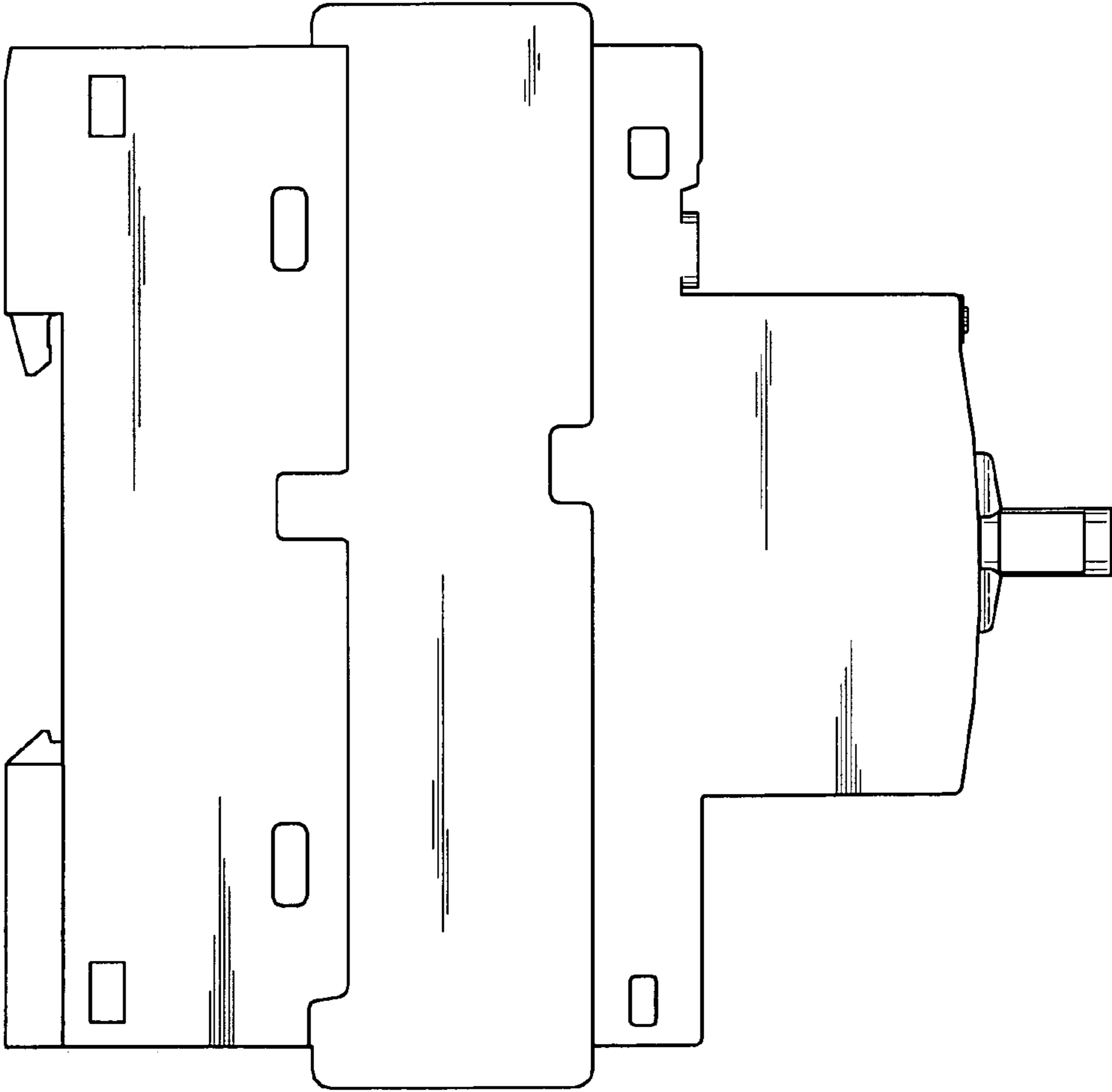

FIG 7

