



US00D629352S

(12) **United States Design Patent**  
**Takano**

(10) **Patent No.:** **US D629,352 S**

(45) **Date of Patent:** **\*\* Dec. 21, 2010**

(54) **TIRE FOR AUTOMOBILE**

(75) Inventor: **Hirokazu Takano**, Kobe (JP)

(73) Assignee: **Sumitomo Rubber Industries, Ltd.**,  
Kobe (JP)

(\*\*) Term: **14 Years**

(21) Appl. No.: **29/366,378**

(22) Filed: **Jul. 23, 2010**

(30) **Foreign Application Priority Data**

Feb. 10, 2010 (JP) ..... 2010-003139

(51) **LOC (9) Cl.** ..... **12-15**

(52) **U.S. Cl.** ..... **D12/605**

(58) **Field of Classification Search** ..... D12/500-501,  
D12/544, 579, 600-605; 152/523-524, DIG. 12,  
152/555; D7/588, 396.4-396.5

See application file for complete search history.

(56) **References Cited**

**U.S. PATENT DOCUMENTS**

D430,518 S *	9/2000	Baker	.....	D12/605
D432,060 S *	10/2000	Baker	.....	D12/605
D516,016 S *	2/2006	Miyazaki et al.	.....	D12/605
D546,273 S *	7/2007	Dumigan	.....	D12/605
D549,166 S *	8/2007	Lee	.....	D12/605
D560,601 S *	1/2008	Lo	.....	D12/605
D569,335 S *	5/2008	Lee	.....	D12/605

D575,728 S *	8/2008	Harvey	.....	D12/605
D577,331 S *	9/2008	Ochi	.....	D12/605
D584,222 S *	1/2009	Ohashi	.....	D12/605
D596,116 S *	7/2009	Fujita	.....	D12/605
D597,024 S *	7/2009	Ochi	.....	D12/605

\* cited by examiner

*Primary Examiner*—Stacia Cadmus

(74) *Attorney, Agent, or Firm*—Birch, Stewart, Kolasch & Birch, LLP

(57) **CLAIM**

The ornamental design for a tire for automobile, as shown and described.

**DESCRIPTION**

FIG. 1 is a front view of a tire for automobile showing my new design;

FIG. 2 is a rear view thereof;

FIG. 3 is a right side view thereof;

FIG. 4 is a left side view thereof;

FIG. 5 is an enlarged view of FIG. 3; and,

FIG. 6 is an enlarged right perspective view of FIG. 5.

The top view and the bottom view are the same as the front view.

The portions in the drawings illustrated in broken lines represent the boundary of the design and therefore form no part of the claimed design.

**1 Claim, 6 Drawing Sheets**

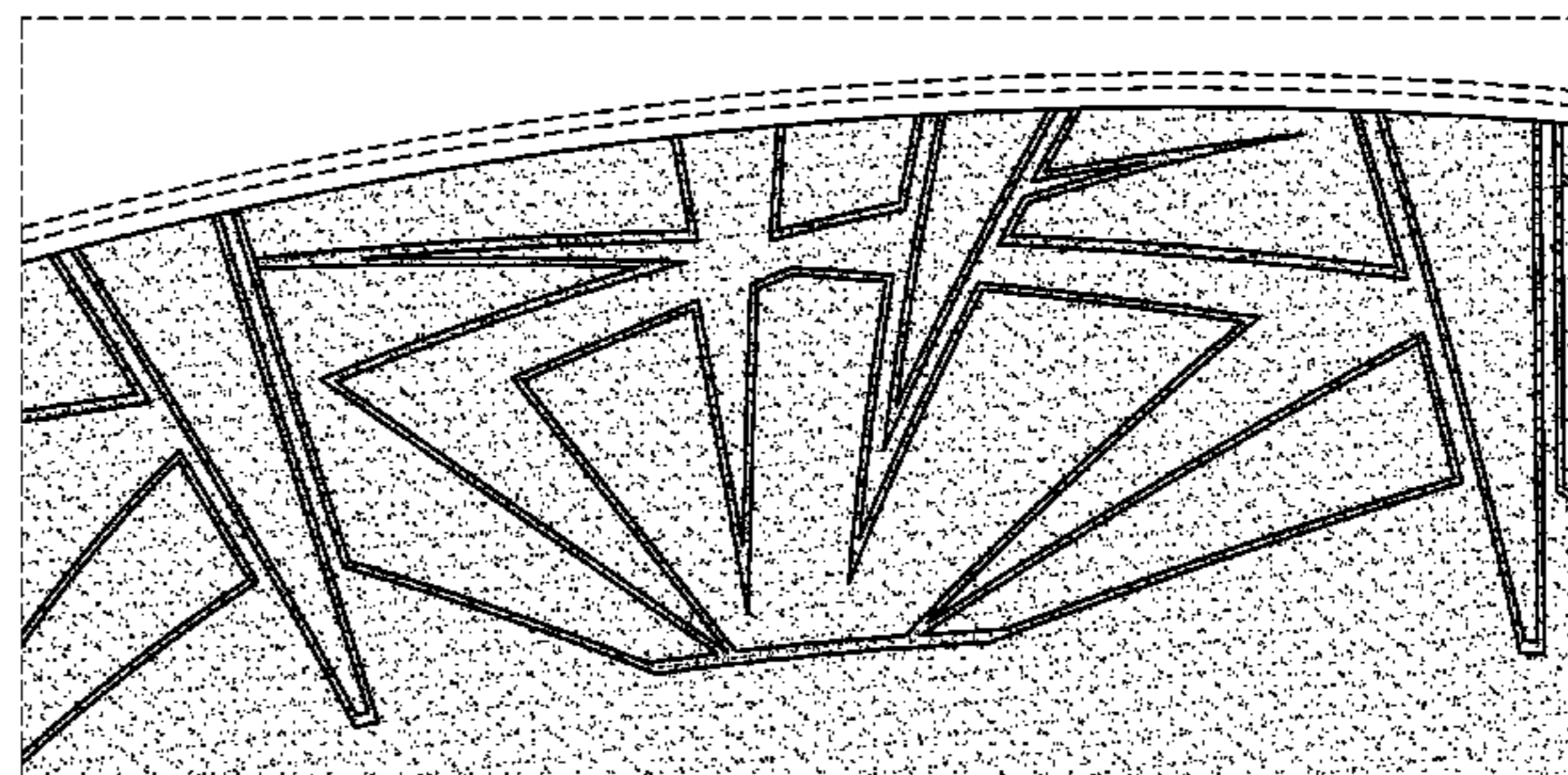
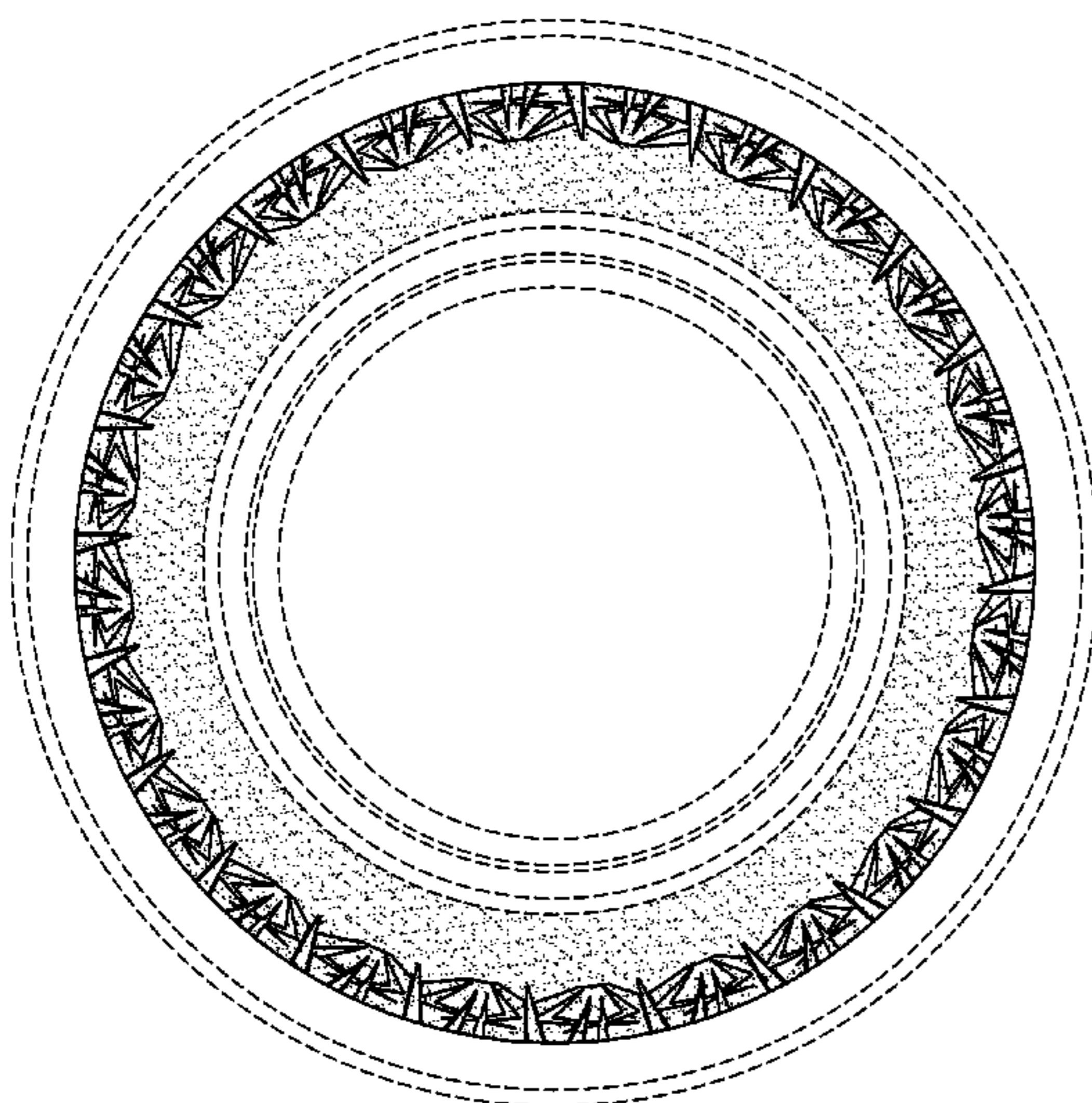

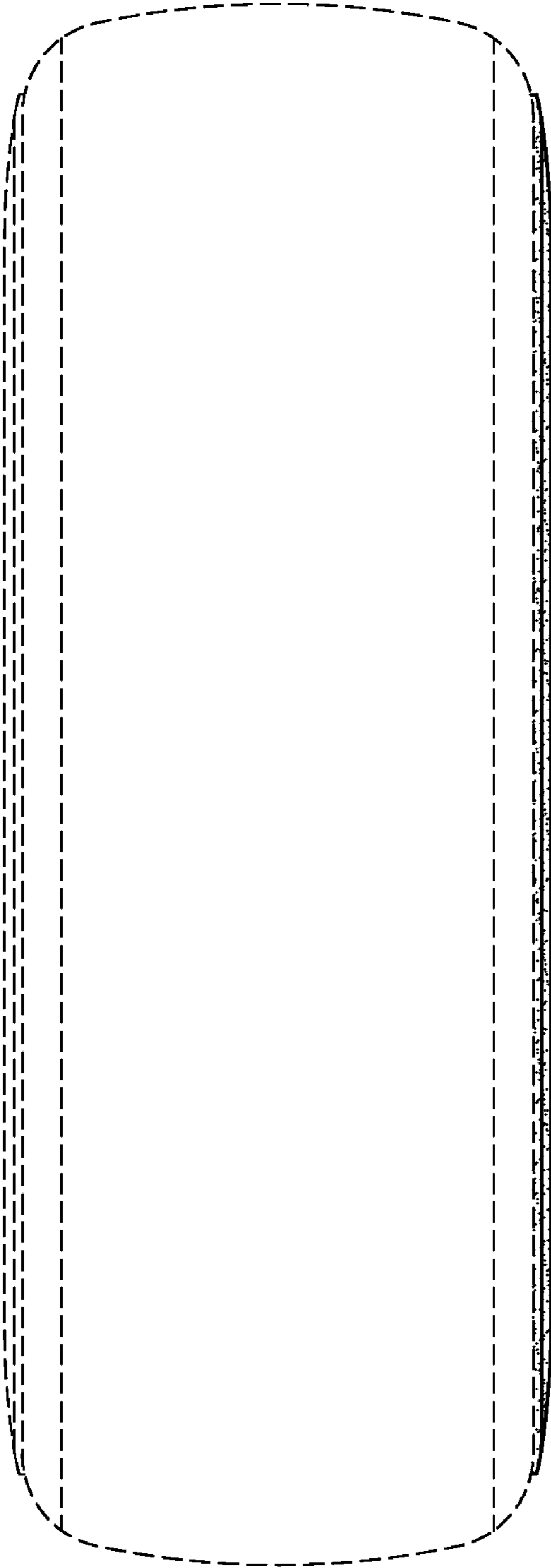

FIG.1

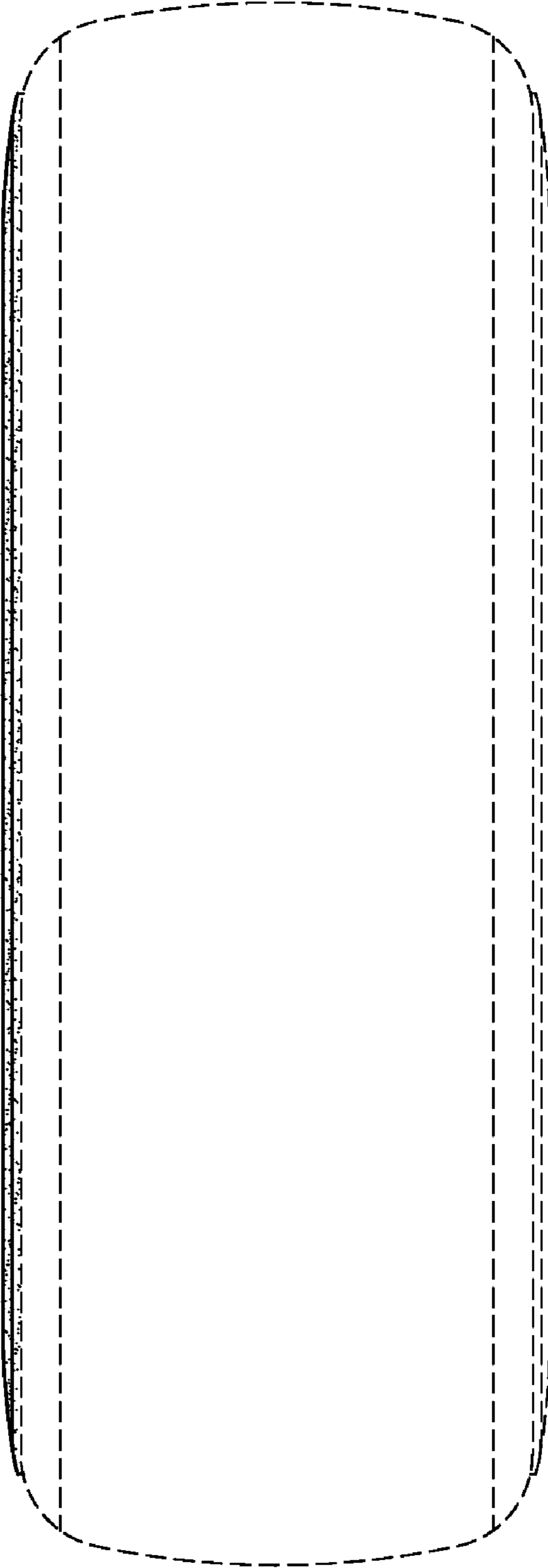

FIG.2



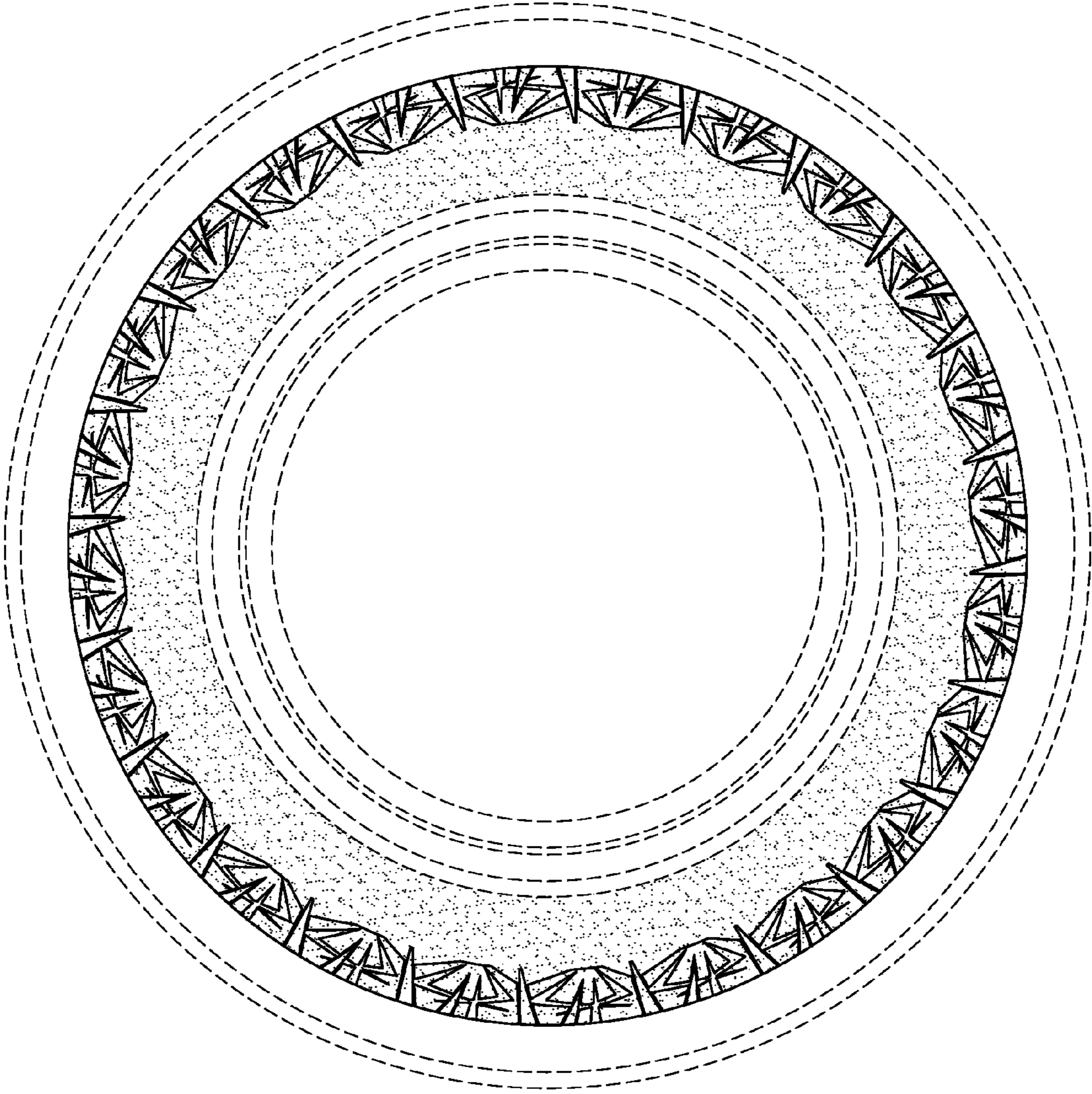

FIG.3

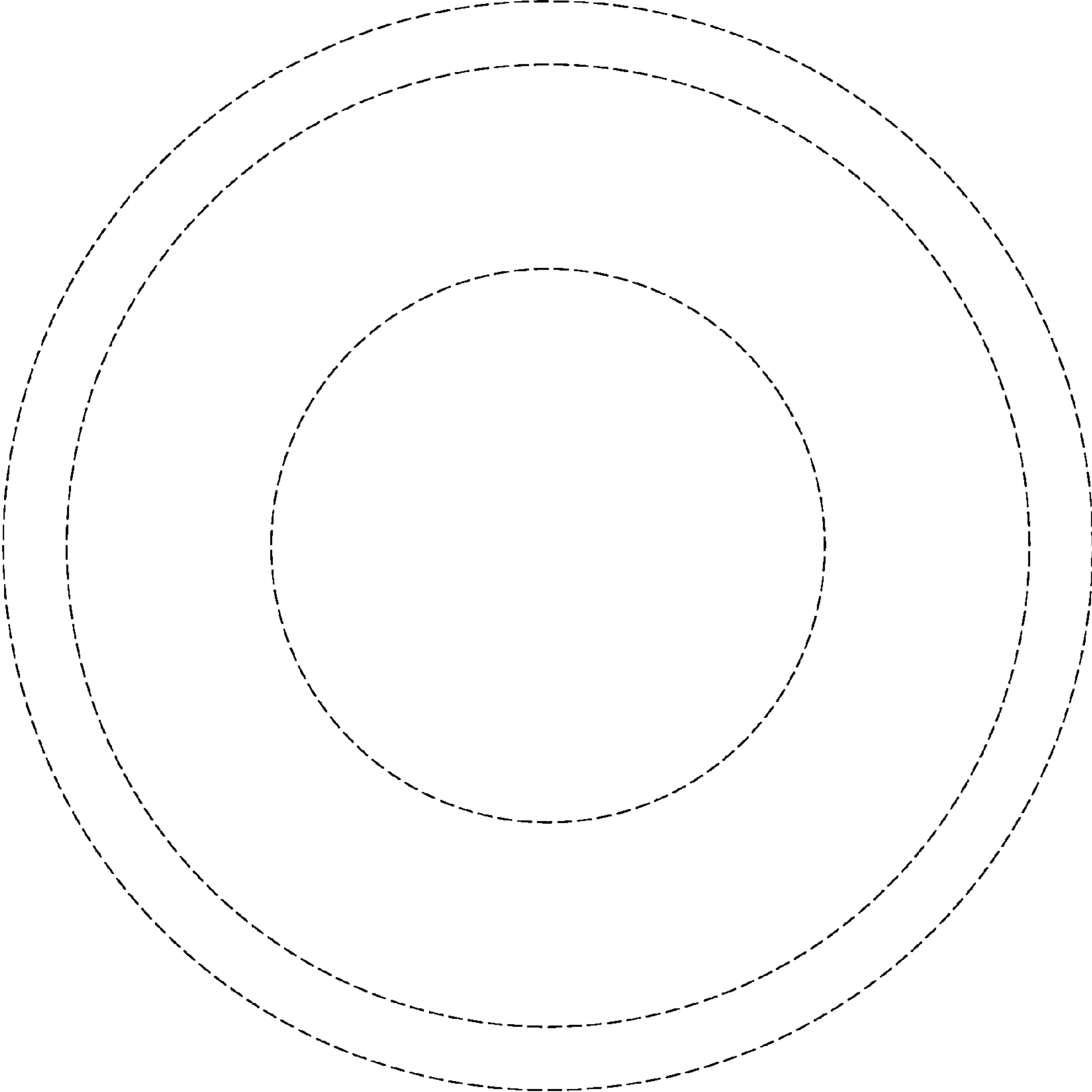

FIG.4

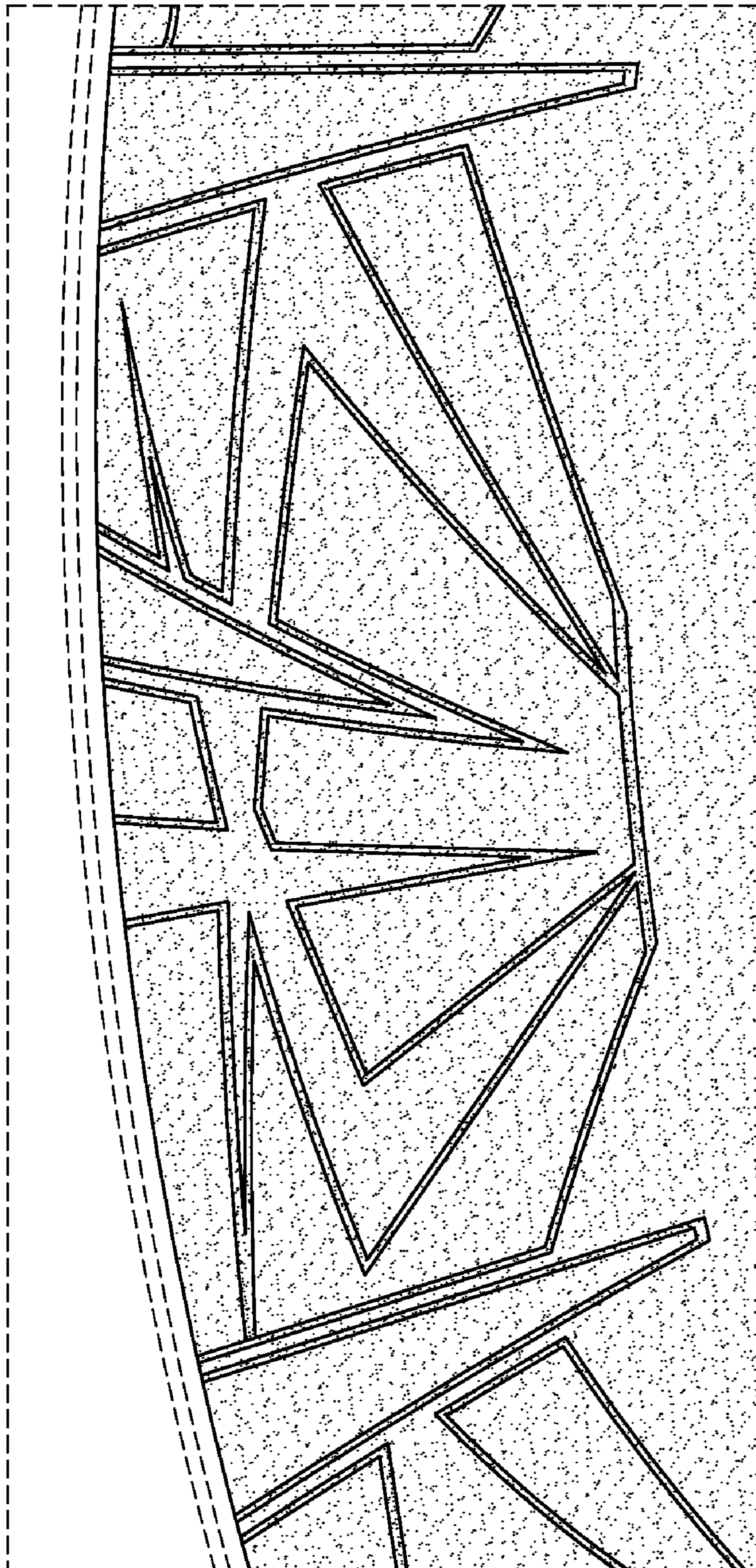

FIG. 5



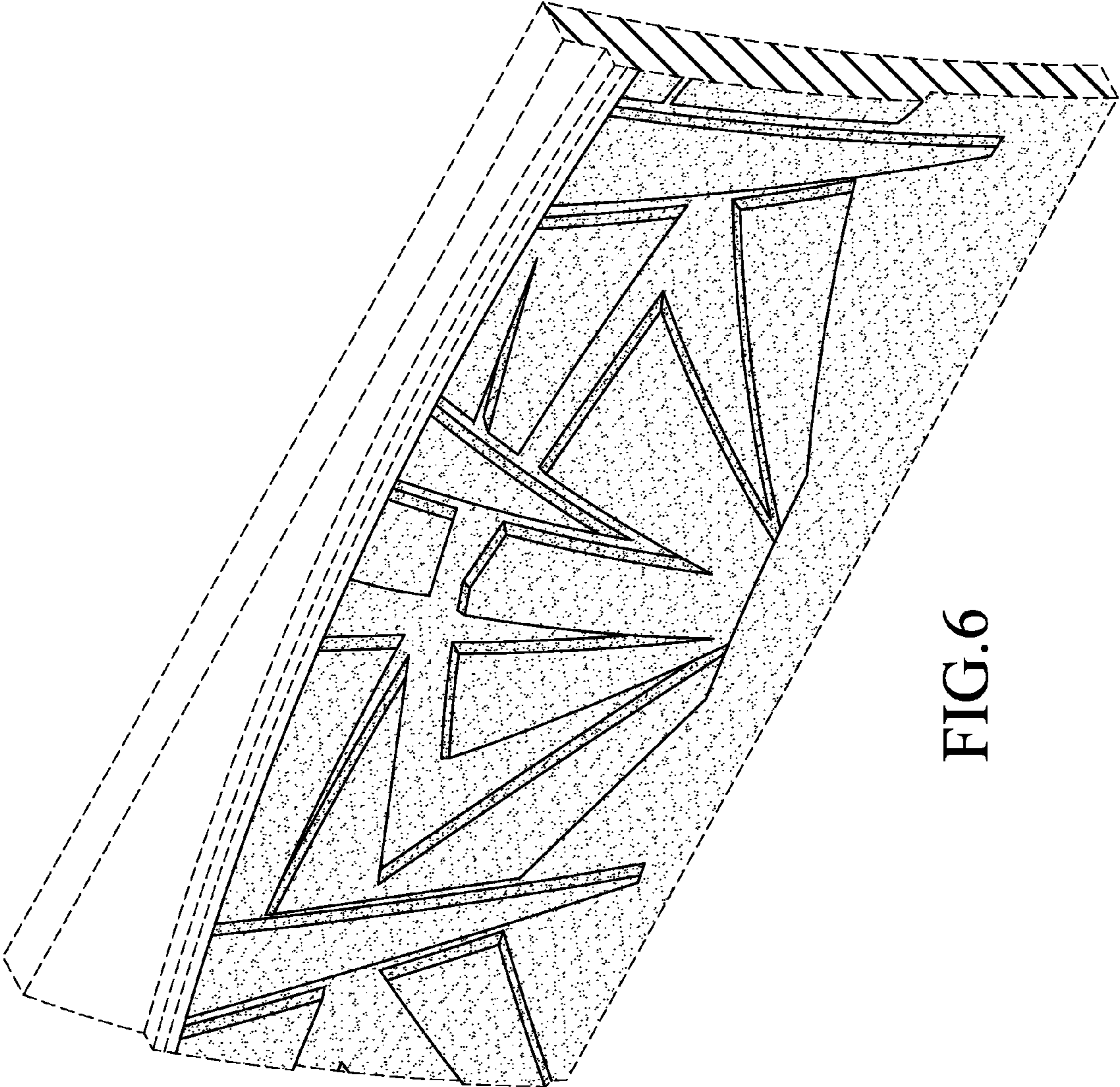

FIG.6