



US00D629274S

(12) **United States Design Patent**
Wu

(10) **Patent No.:** **US D629,274 S**

(45) **Date of Patent:** **** *Dec. 21, 2010**

(54) **CARPENTER KNIFE**

(76) Inventor: **Yuewei Wu**, Ningbo Xingwei Plastic Co., Ltd., Industrial Zone of Xidian, Ninghai, Zhejiang Province (CN) 315613

(*) Notice: This patent is subject to a terminal disclaimer.

(**) Term: **14 Years**

(21) Appl. No.: **29/290,783**

(22) Filed: **Jan. 14, 2008**

(51) **LOC (9) Cl.** **08-03**

(52) **U.S. Cl.** **D8/99**

(58) **Field of Classification Search** D8/99,
D8/99; 30/162, 320, 335, 336, 337, 125
See application file for complete search history.

(56) **References Cited**

U.S. PATENT DOCUMENTS

D410,832 S *	6/1999	Chong	D8/99
D413,247 S *	8/1999	Schmidt	D8/99
D414,394 S *	9/1999	Chong	D8/99
D420,270 S *	2/2000	Martone	D8/99
D434,960 S *	12/2000	Lamond et al.	D8/99
D439,492 S *	3/2001	Martone et al.	D8/99

D458,526 S *	6/2002	Budrow	D8/99
D506,664 S *	6/2005	Budrow	D8/99
D509,419 S *	9/2005	Chung	D8/99
D524,138 S *	7/2006	Chih	D8/99
D551,932 S *	10/2007	Guo	D8/99

* cited by examiner

Primary Examiner—Philip S Hyder
Assistant Examiner—Roselyne Cody

(57) **CLAIM**

The ornamental design for the carpenter knife, as shown and described.

DESCRIPTION

FIG. 1 is a front view showing my new design;
FIG. 2 is a rear view thereof;
FIG. 3 is a left side view thereof;
FIG. 4 is right side view thereof;
FIG. 5 is a perspective view thereof;
FIG. 6 is a top view thereof; and,
FIG. 7 is a bottom view thereof.
The broken lines are for illustrative purposes only and form no part of the claimed design.

1 Claim, 3 Drawing Sheets

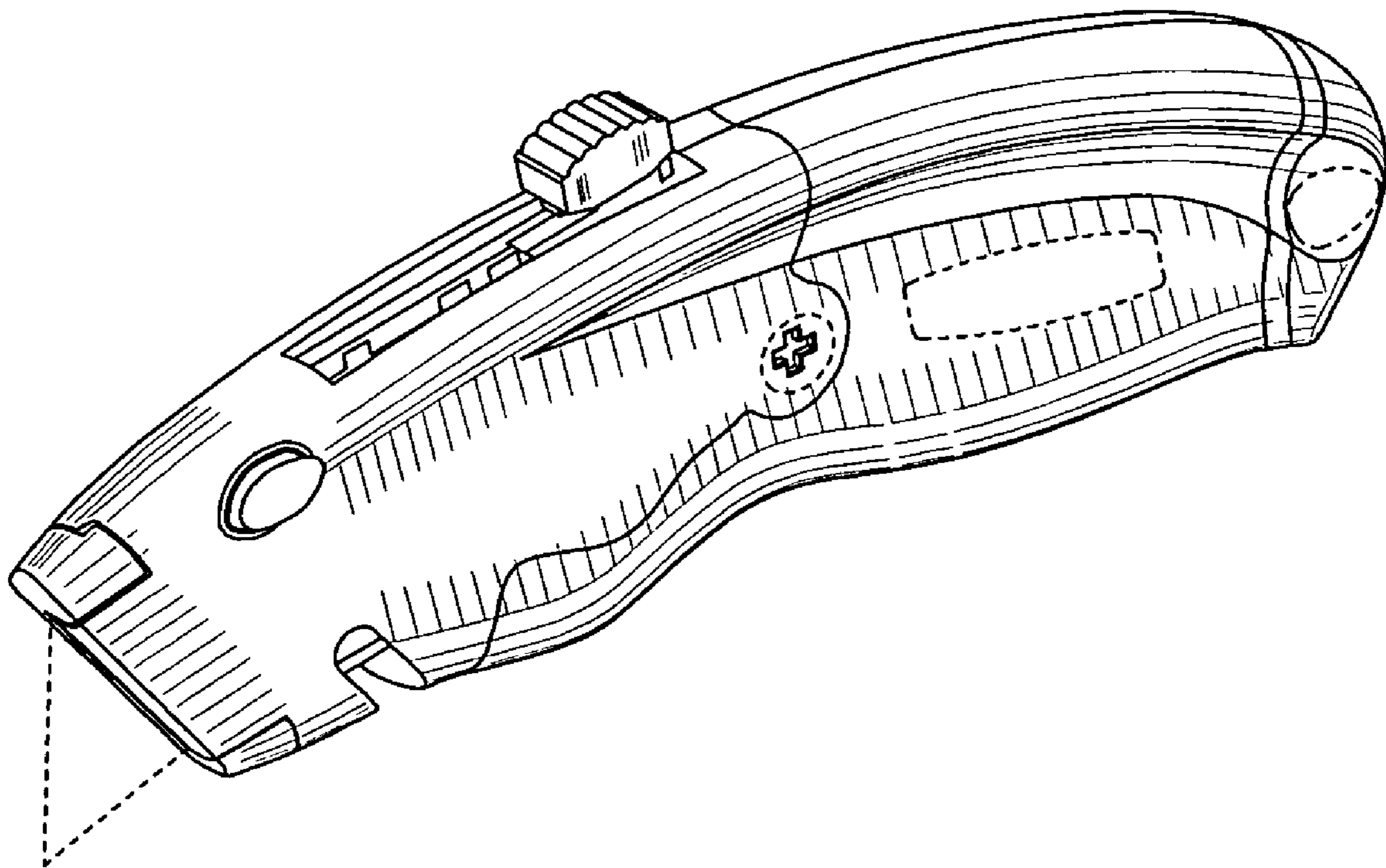

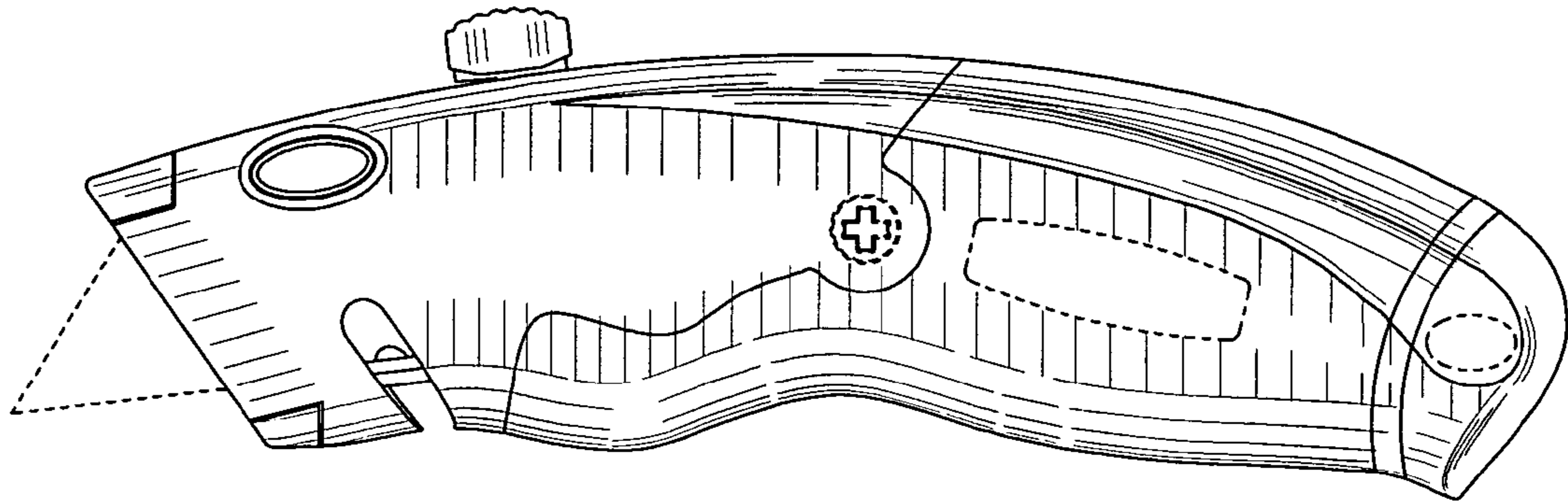

FIG. 1

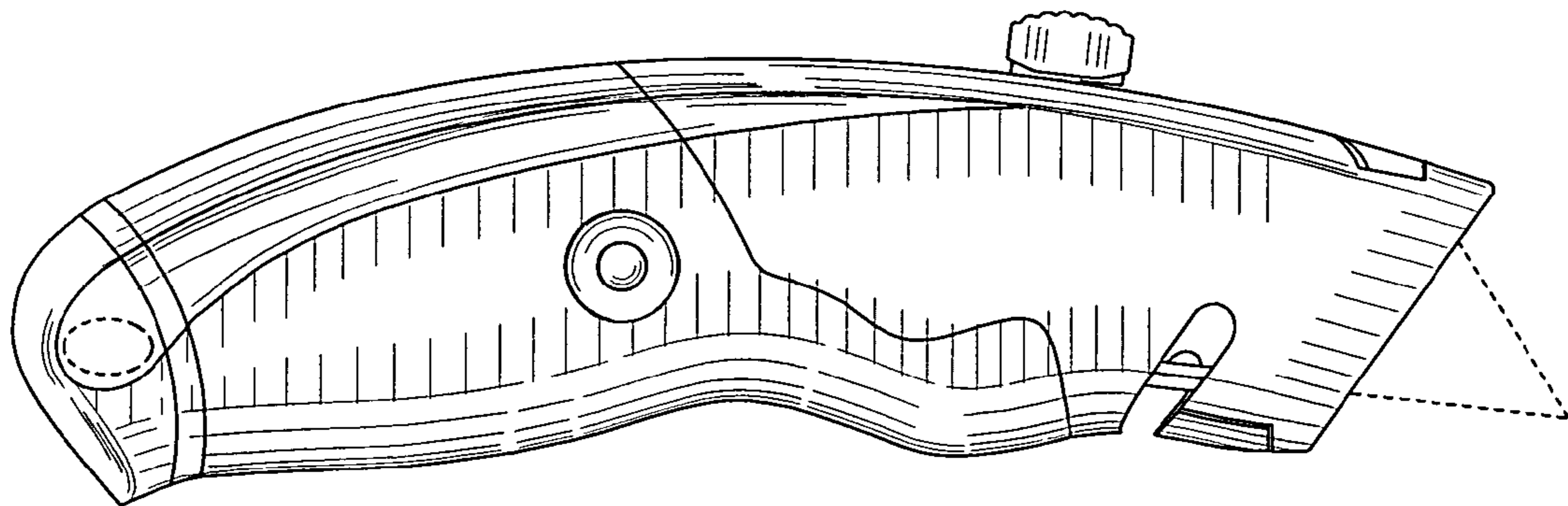

FIG. 2

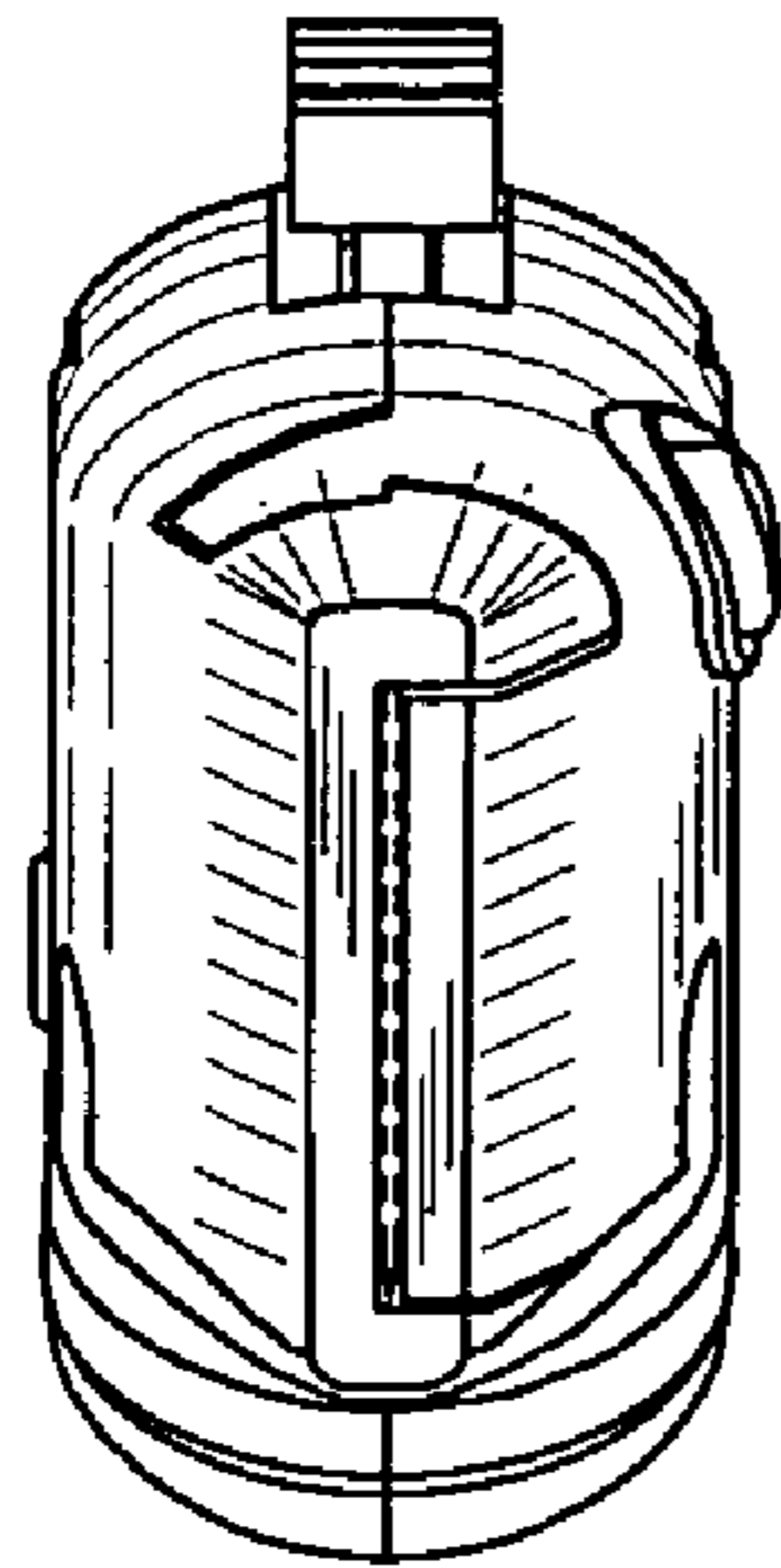

FIG. 3

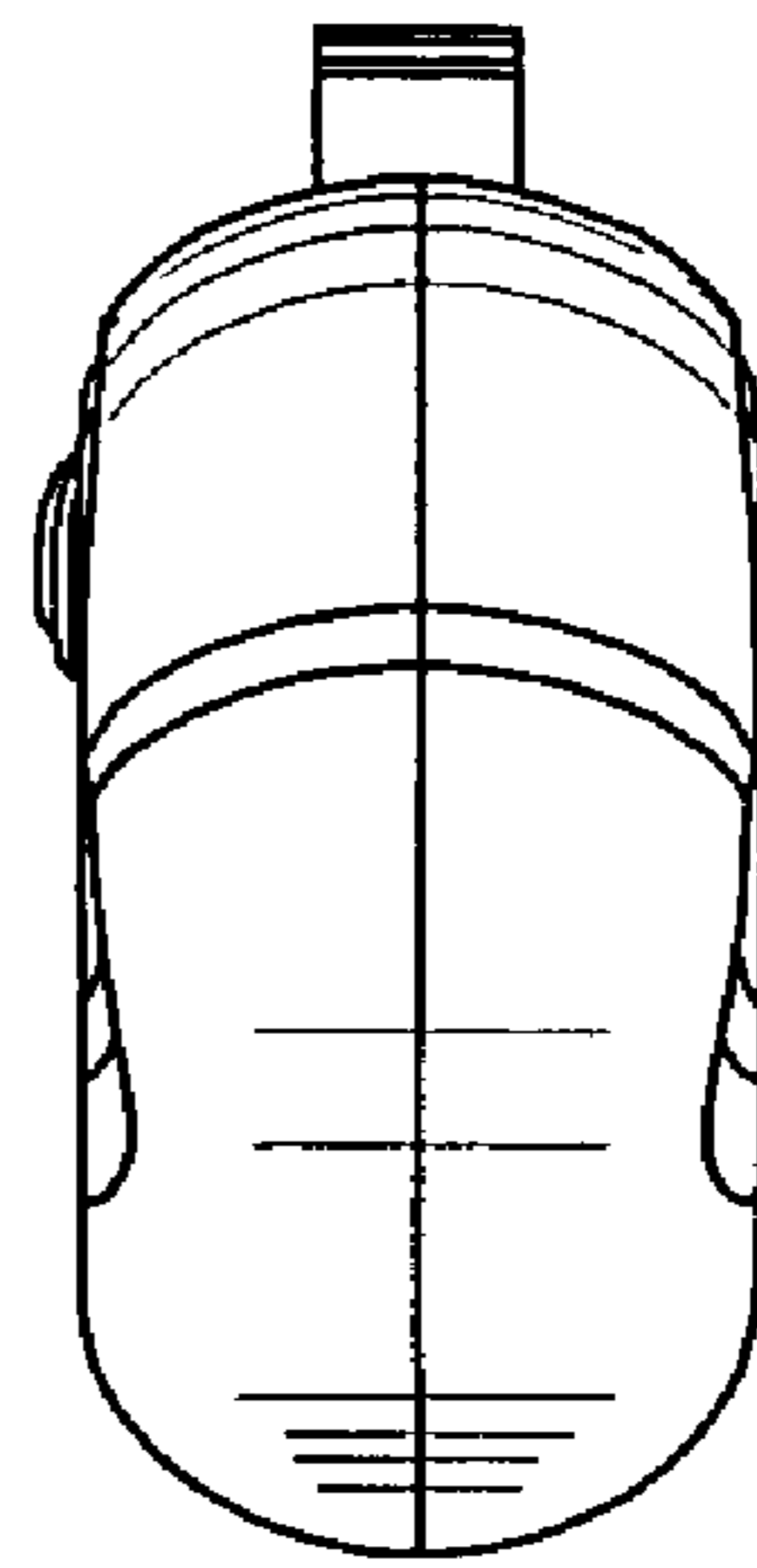

FIG. 4

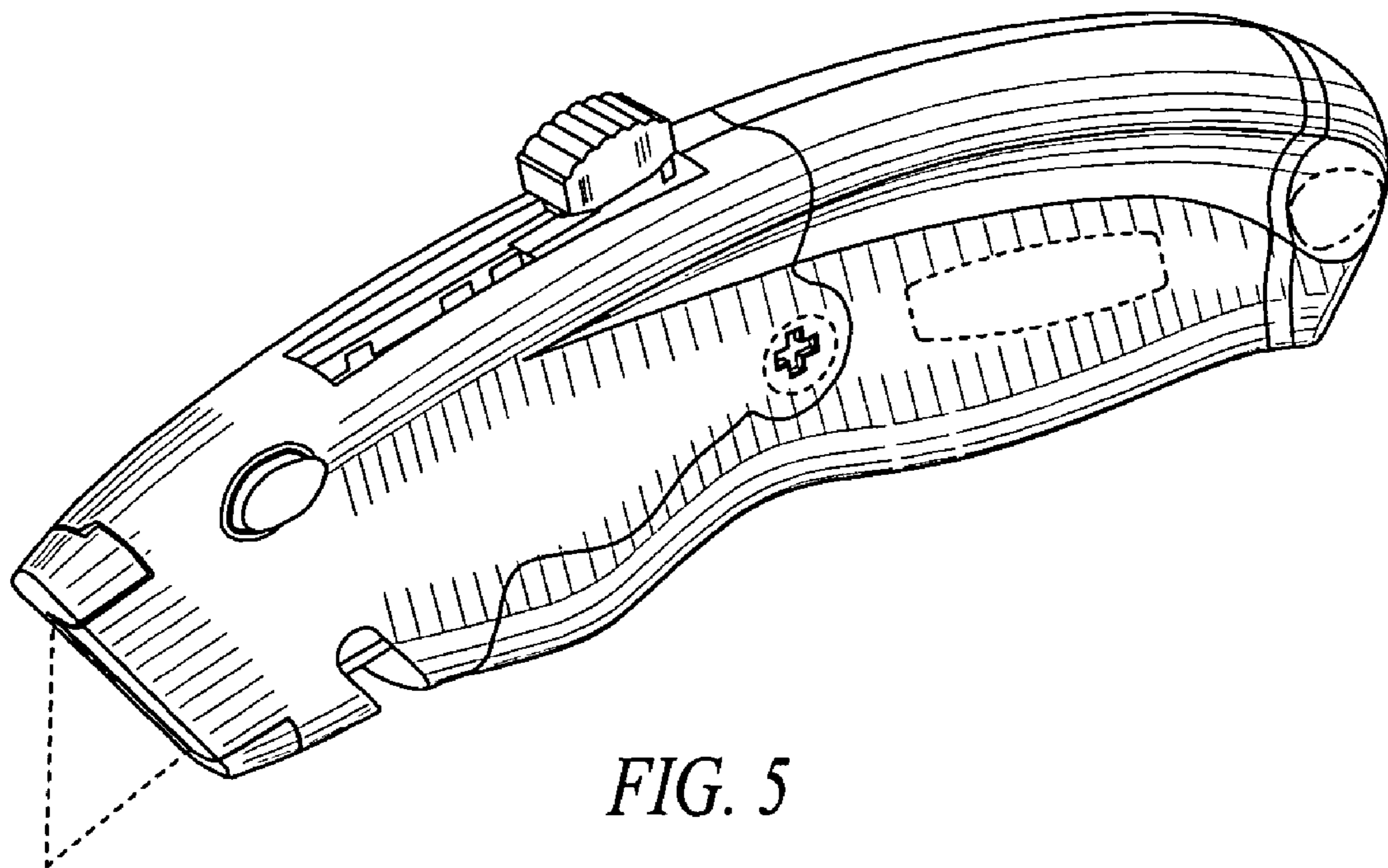

FIG. 5

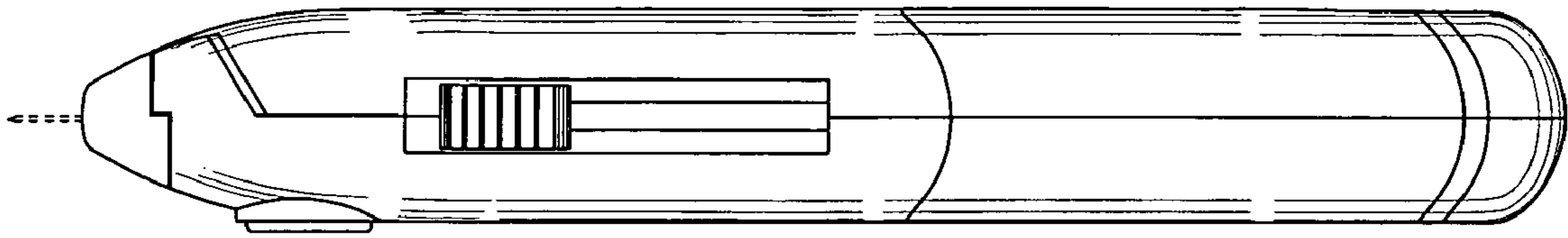

FIG. 6

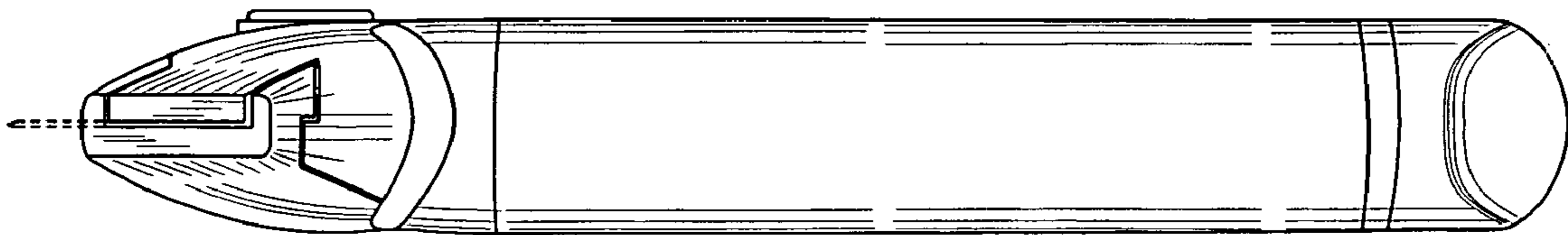

FIG. 7