

US00D629237S

(12) **United States Design Patent**
Boshuizen et al.

(10) **Patent No.:** **US D629,237 S**
(45) **Date of Patent:** **** Dec. 21, 2010**

- (54) **LIQUID DISPENSER**
- (75) Inventors: **Sylvia Boshuizen**, Leiden (NL); **Maria Levina Weststrate**, The Hague (NL); **Don Presnell**, Stephens City, VA (US)
- (73) Assignee: **Rubbermaid Commercial Products, LLC**, Winchester, VA (US)
- (**) Term: **14 Years**
- (21) Appl. No.: **29/362,228**
- (22) Filed: **May 21, 2010**
- (51) **LOC (9) Cl.** **23-02**
- (52) **U.S. Cl.** **D6/545**
- (58) **Field of Classification Search** D6/542-545;
221/208, 282, 283; 222/105, 173, 180, 181.1,
222/181.2, 181.3
See application file for complete search history.

- 6,769,580 B2 8/2004 Muderlak et al.
- D537,929 S 3/2007 Muderlak et al.
- D553,407 S * 10/2007 Orgna et al. D6/545
- 7,611,033 B2 11/2009 Ganzeboom
- D616,684 S * 6/2010 Ciavarella et al. D6/545
- D617,129 S * 6/2010 Ciavarella et al. D6/545
- 2010/0025427 A1 2/2010 Chiou et al.
- 2010/0059602 A1 3/2010 Chiou et al.

OTHER PUBLICATIONS

Co-Pending U.S. Appl. No. 29/362,227, filed May 21, 2010.

* cited by examiner

Primary Examiner—Brian N Vinson
(74) *Attorney, Agent, or Firm*—Dennis J. Williamson; Moore & Van Allen, PLLC

(57) **CLAIM**

We claim the ornamental design for a liquid dispenser, as shown and described.

DESCRIPTION

FIG. 1 is a perspective view showing our new design for a liquid dispenser

FIG. 2 is a front view showing our new design shown in FIG. 1;

FIG. 3 is a right side view showing our new design shown in FIG. 1, the left side view being identical;

FIG. 4 is a top view showing our new design shown in FIG. 1;

FIG. 5 is a back view showing our new design shown in FIG. 1; and,

FIG. 6 is a bottom view showing our new design shown in FIG. 1.

The broken-line disclosure is understood to represent portions of the article in which the claimed design is embodied, but which form no part of the claimed design.

1 Claim, 6 Drawing Sheets

(56) **References Cited**
U.S. PATENT DOCUMENTS

- 5,038,972 A 8/1991 Muderlak et al.
- D323,884 S 2/1992 Muderlak
- D325,253 S 4/1992 Muderlak
- 5,111,477 A 5/1992 Muderlak
- D338,522 S 8/1993 Muderlak
- 5,249,718 A 10/1993 Muderlak
- RE34,847 E 2/1995 Muderlak et al.
- D357,977 S 5/1995 Muderlak
- 5,449,117 A 9/1995 Muderlak et al.
- D363,981 S 11/1995 Muderlak
- D366,520 S 1/1996 Muderlak
- 5,823,390 A 10/1998 Muderlak et al.
- D401,093 S * 11/1998 Arbak et al. D6/545
- 5,884,808 A 3/1999 Muderlak et al.
- 5,908,140 A 6/1999 Muderlak et al.
- D426,094 S * 6/2000 Carlson D6/545
- D458,788 S * 6/2002 Real D6/545
- D473,087 S * 4/2003 Chen D6/545

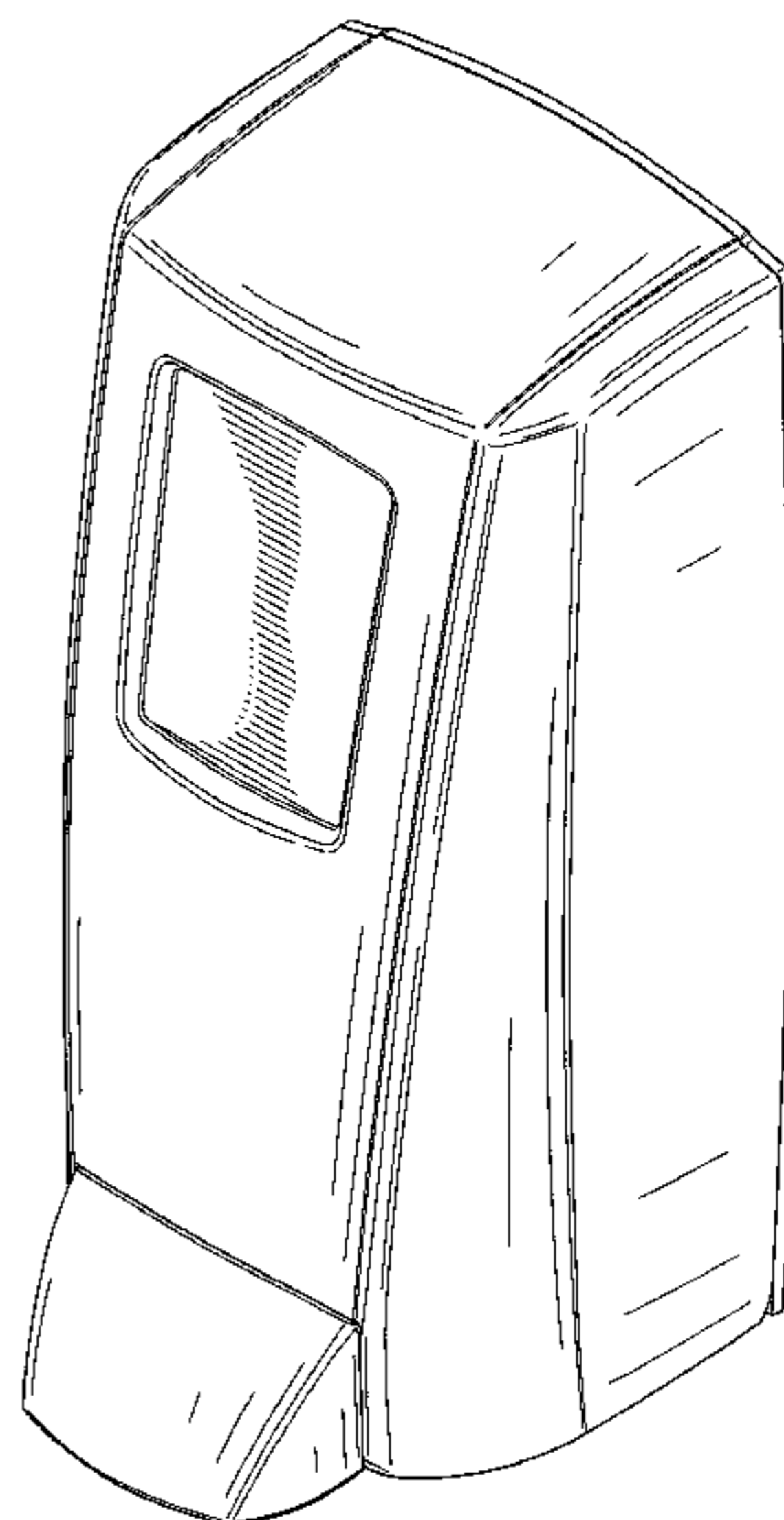

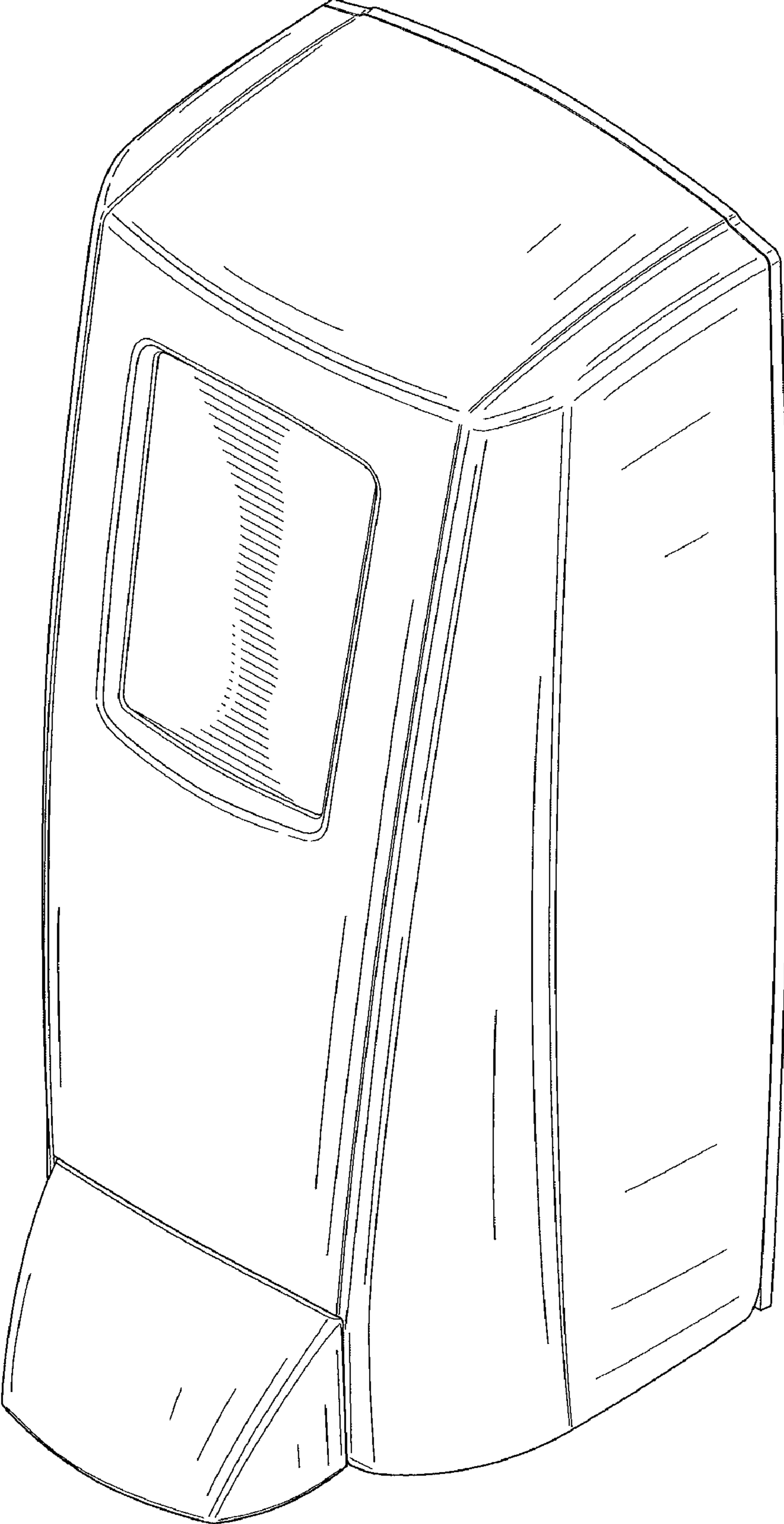

FIG. 1

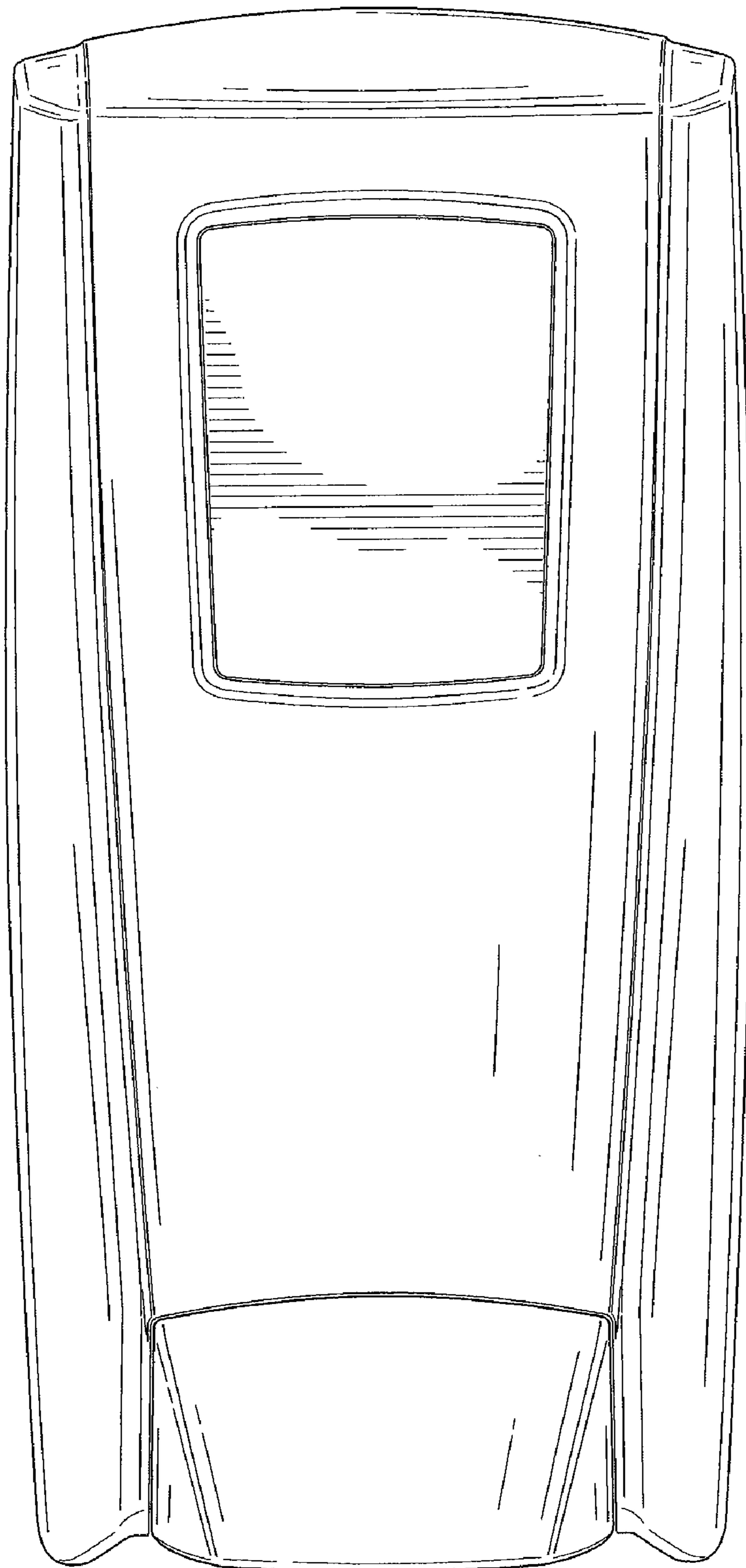

FIG. 2

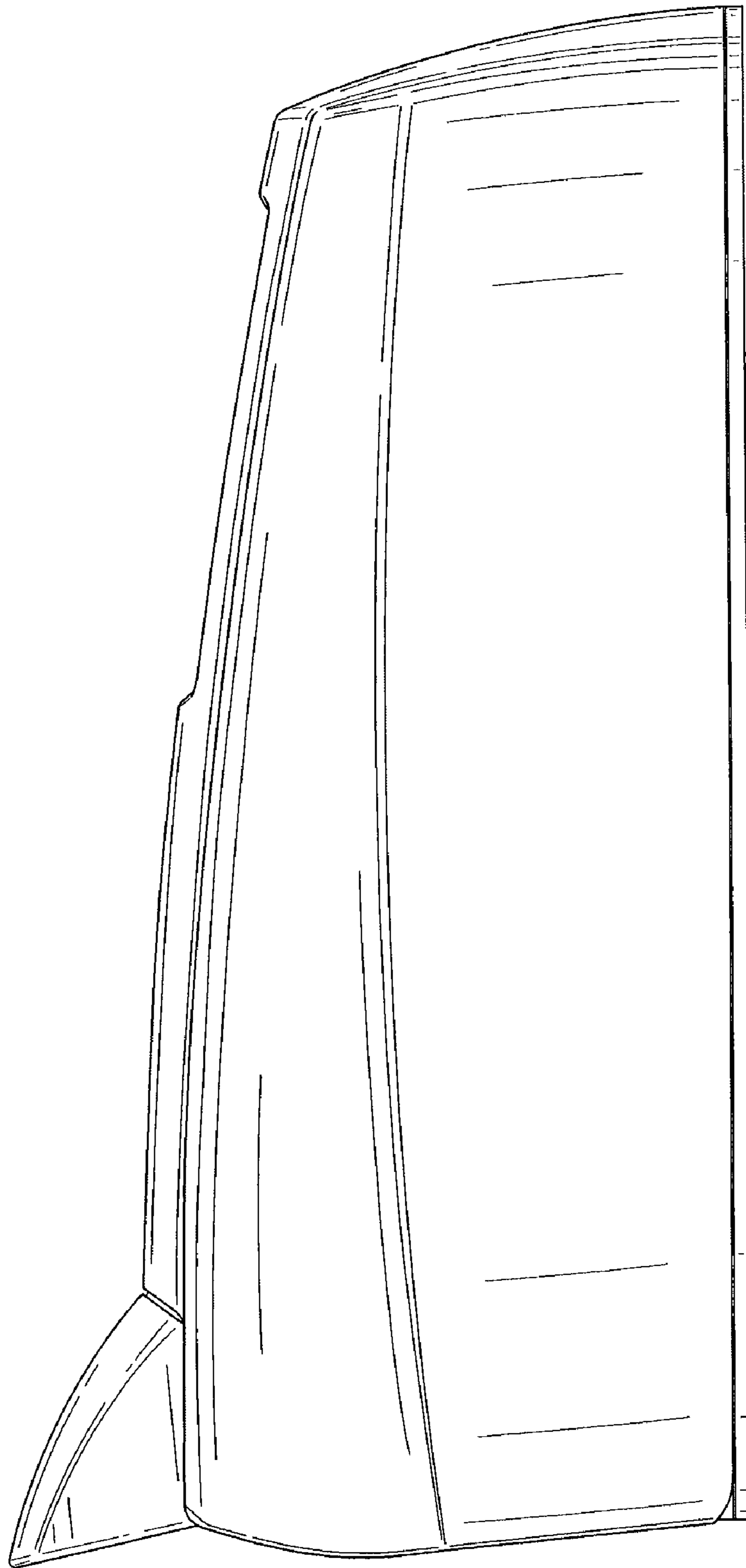

FIG. 3

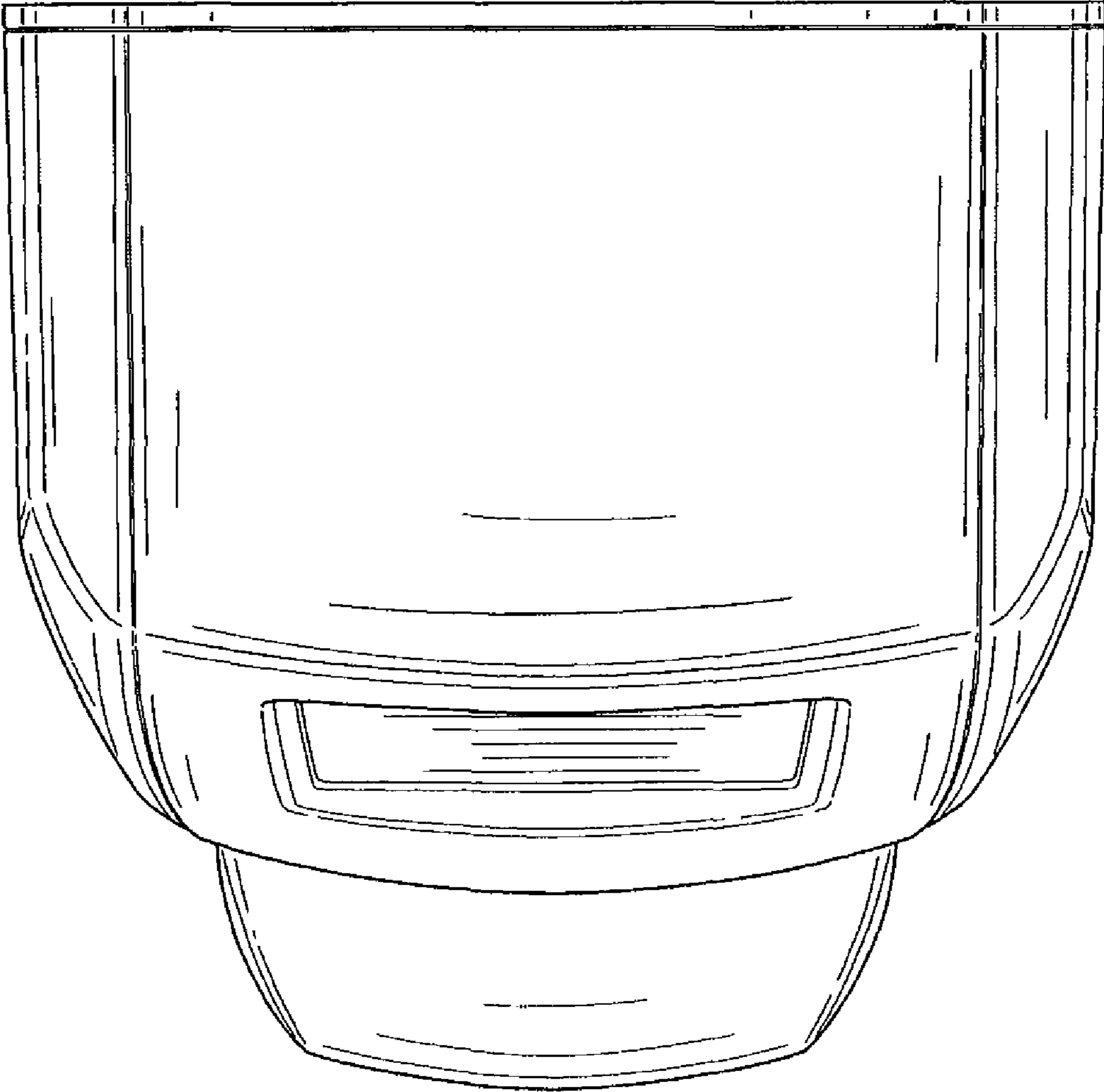

FIG. 4

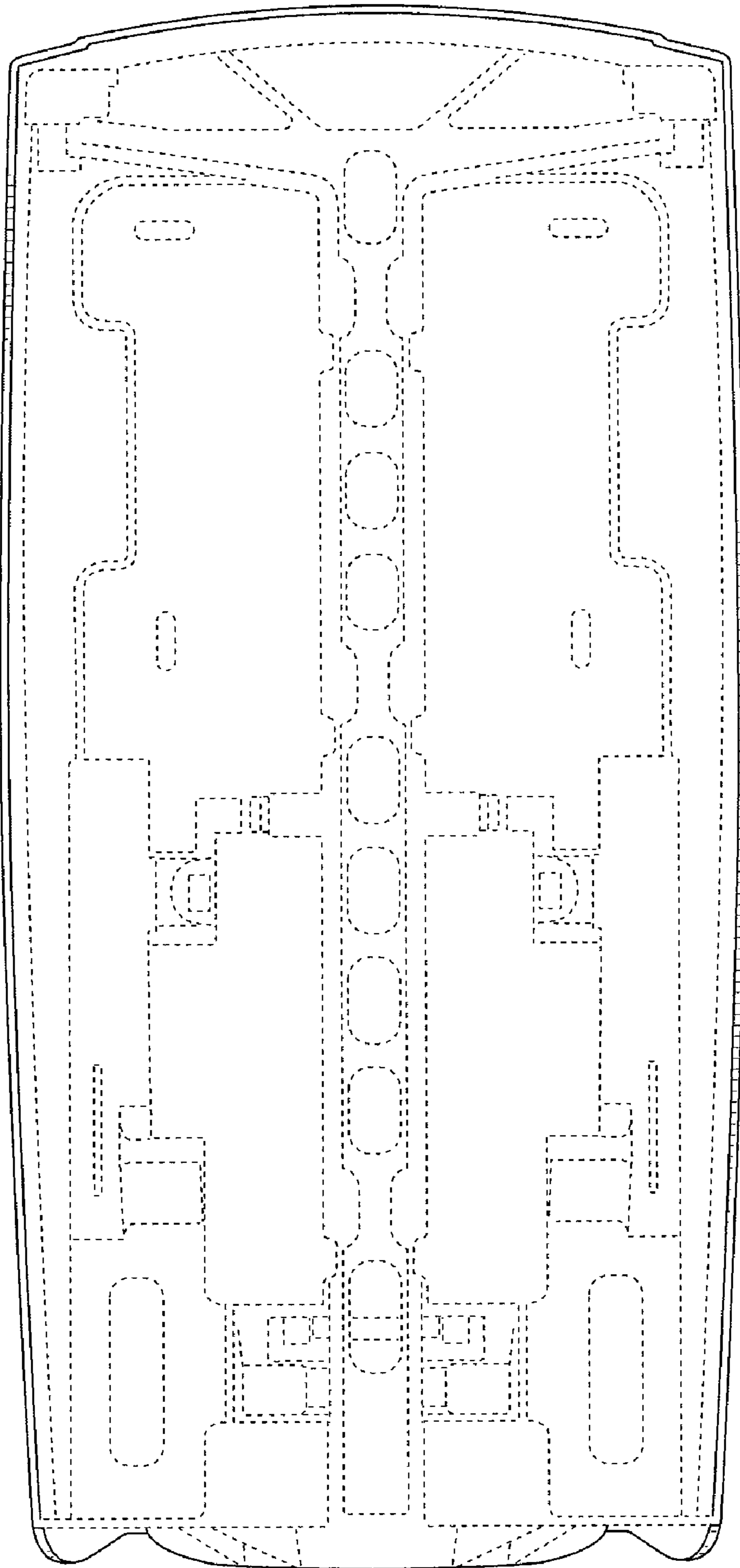

FIG. 5

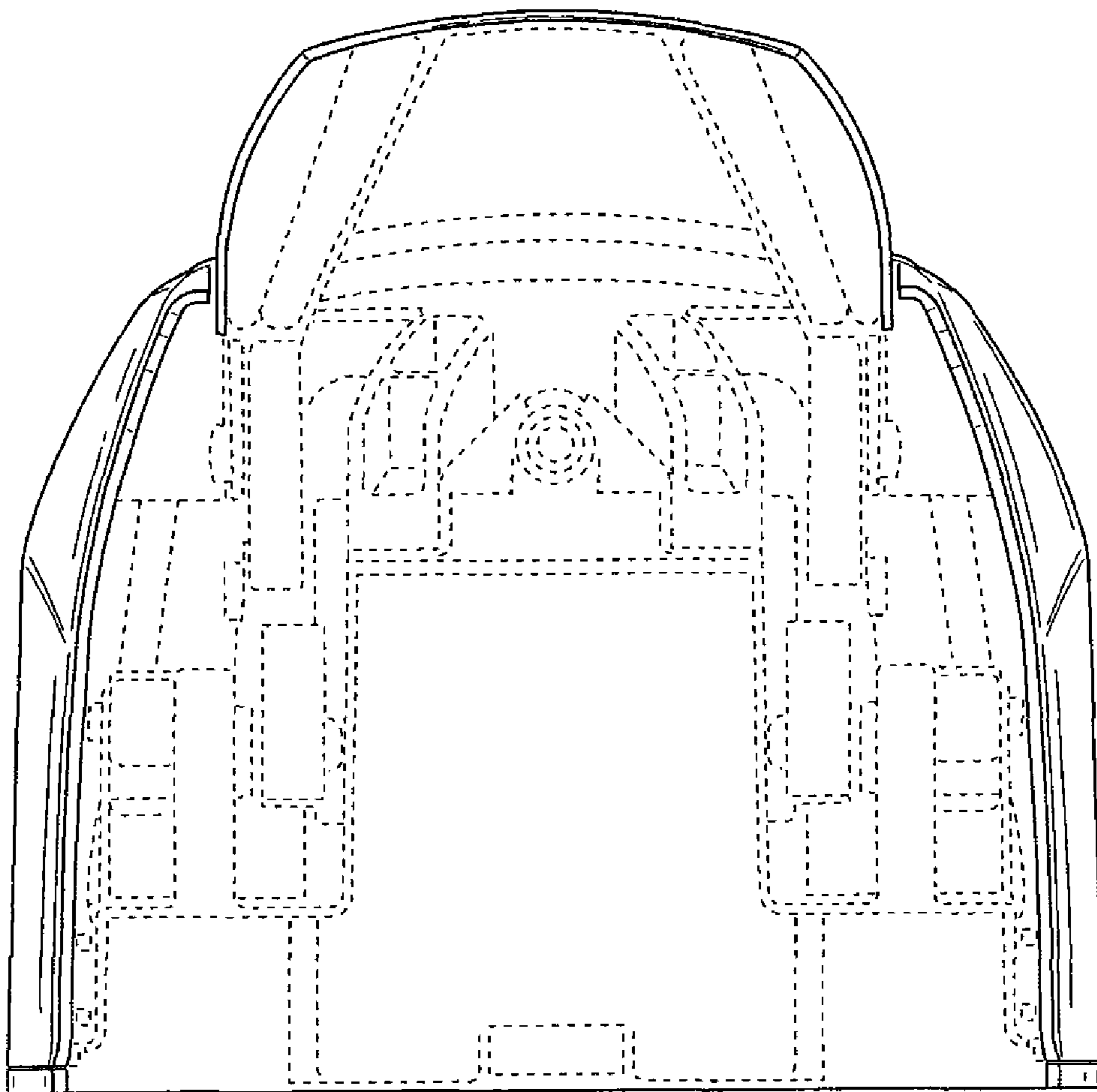

FIG. 6