



US00D629149S

(12) **United States Design Patent**
Donegani et al.

(10) **Patent No.:** **US D629,149 S**
(45) **Date of Patent:** **** Dec. 14, 2010**

(54) **MULTIFUNCTIONAL LAMP**

(75) Inventors: **Dante Vittorino Donegani**, Milan (IT);
Giovanni Lauda, Milan (IT)

(73) Assignee: **Rotaliana S.R.L.**, Mezzolombardo (IT)

(**) Term: **14 Years**

(21) Appl. No.: **29/311,790**

(22) Filed: **Jun. 24, 2009**

(30) **Foreign Application Priority Data**

Jan. 21, 2009 (EM) 001073209

(51) **LOC (9) Cl.** **26-03**

(52) **U.S. Cl.** **D26/93**

(58) **Field of Classification Search** D26/1,
D26/24, 61, 6, 93-94, 101, 104-110, 113;
362/3, 153, 186, 217, 255, 257, 277, 317,
362/351, 353, 362, 363, 382, 431, 433, 458,
362/806

See application file for complete search history.

(56) **References Cited**

U.S. PATENT DOCUMENTS

- D315,803 S * 3/1991 Lin D26/63
- D351,246 S * 10/1994 Yuen D26/65
- D580,578 S * 11/2008 Chien D26/63
- D600,845 S * 9/2009 Thomson et al. D26/65

* cited by examiner

Primary Examiner—Brian N Vinson

(74) *Attorney, Agent, or Firm*—Modiano & Associati; Albert Josie; Daniel J. O'Byrne

(57) **CLAIM**

The ornamental design for a multifunctional lamp, as shown.

DESCRIPTION

FIG. 1 is a perspective view of a multifunctional lamp, showing our new design;

FIG. 2 is a front view thereof;

FIG. 3 is a rear view thereof;

FIG. 4 is a left side view thereof;

FIG. 5 is a right side view thereof;

FIG. 6 is a top view thereof;

FIG. 7 is a bottom view thereof;

FIG. 8 is a perspective view of the multifunctional lamp, with the drawer open;

FIG. 9 is a front view thereof;

FIG. 10 is a rear view thereof;

FIG. 11 is a left side view thereof;

FIG. 12 is a right side view thereof;

FIG. 13 is a top view thereof;

FIG. 14 is a bottom view thereof;

FIG. 15 is a perspective view of the multifunctional lamp, with the folding arm open, in which a source of light is accommodated;

FIG. 16 is a front view thereof;

FIG. 17 is a rear view thereof;

FIG. 18 is a left side view thereof;

FIG. 19 is a right side view thereof;

FIG. 20 is a top view thereof; and,

FIG. 21 is a bottom view thereof.

The broken-line disclosure in the views is understood to represent portions of the article in which the claimed design is embodied, but which forms no part of the claimed design.

1 Claim, 21 Drawing Sheets

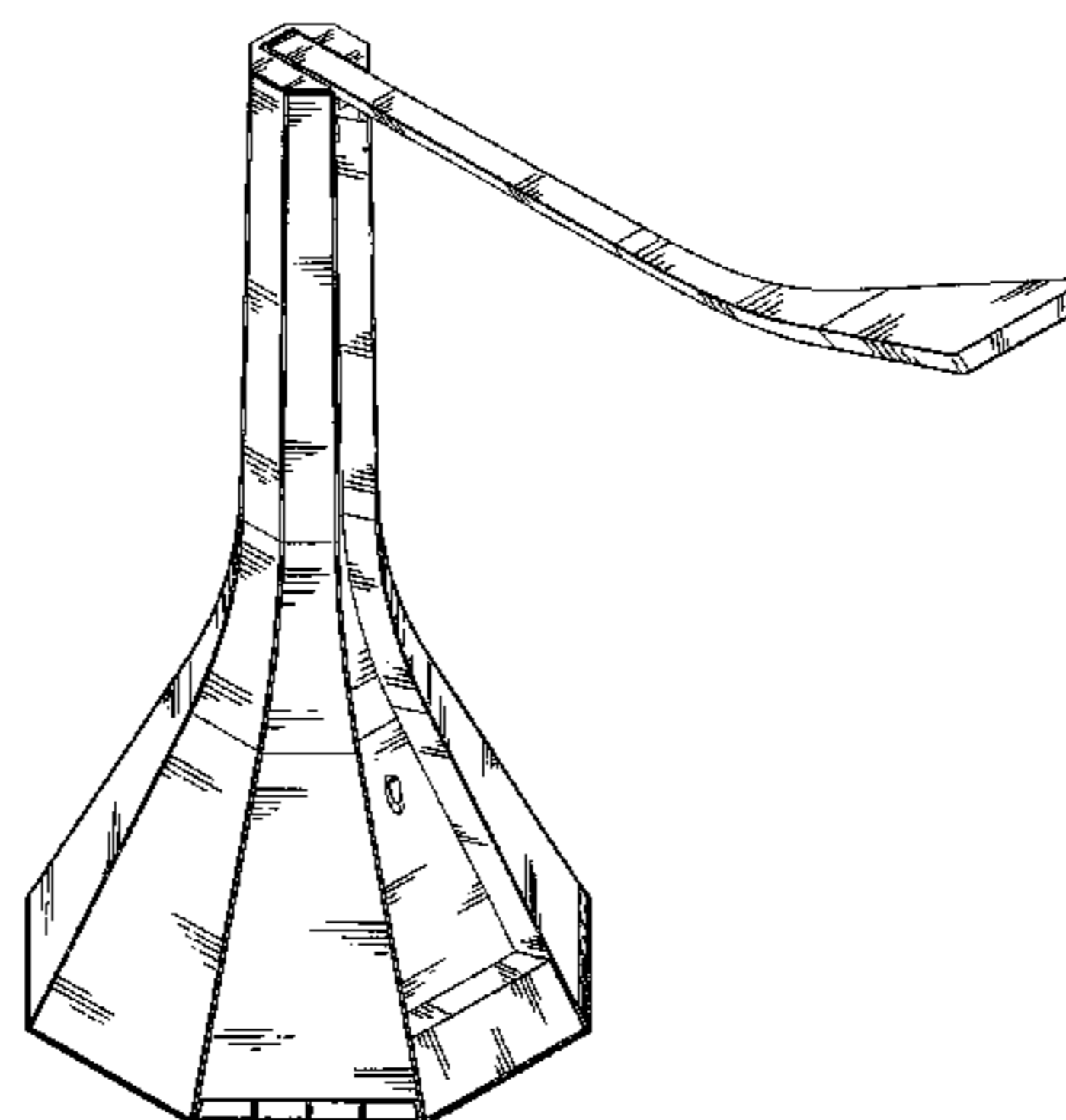
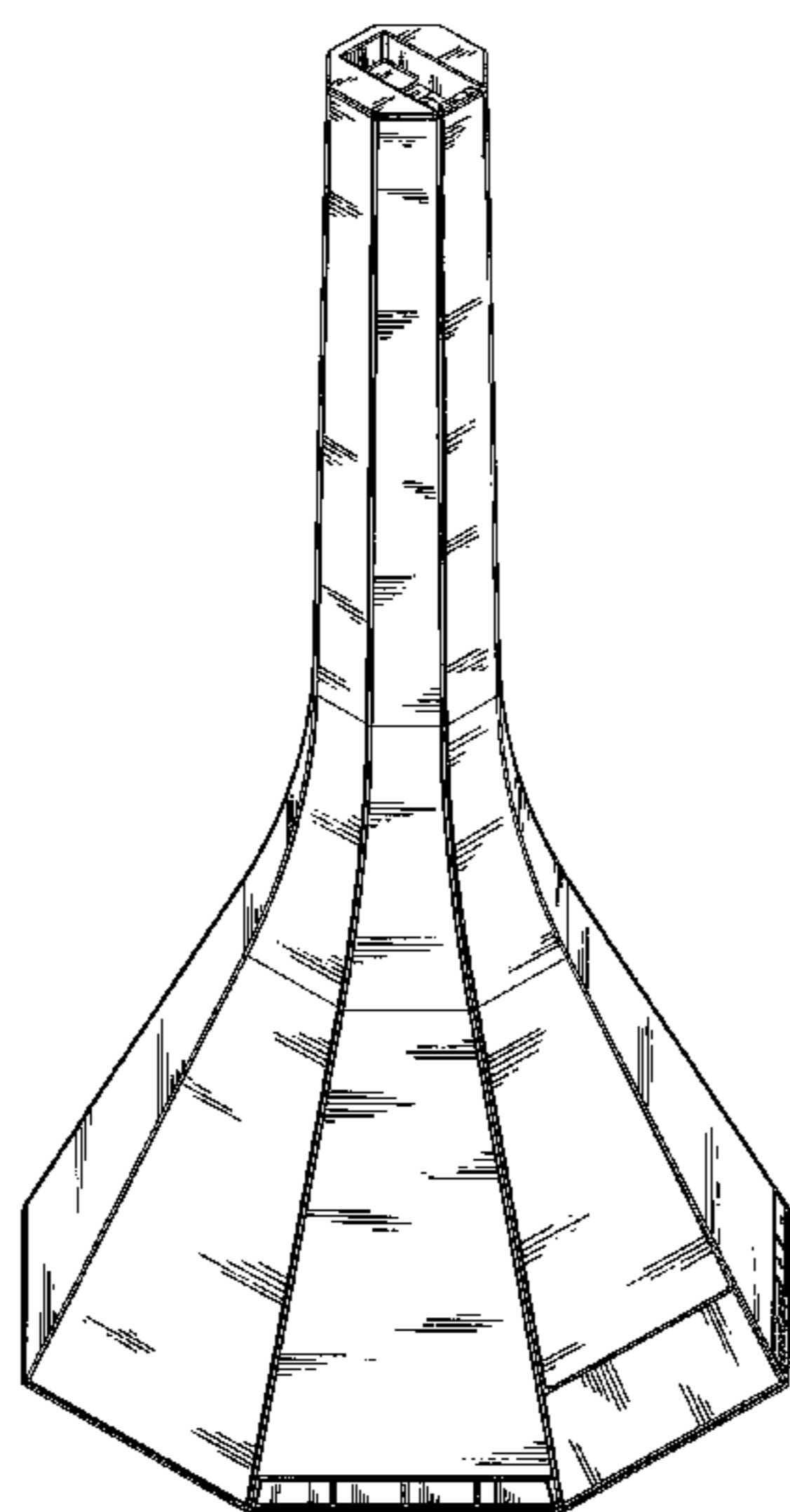

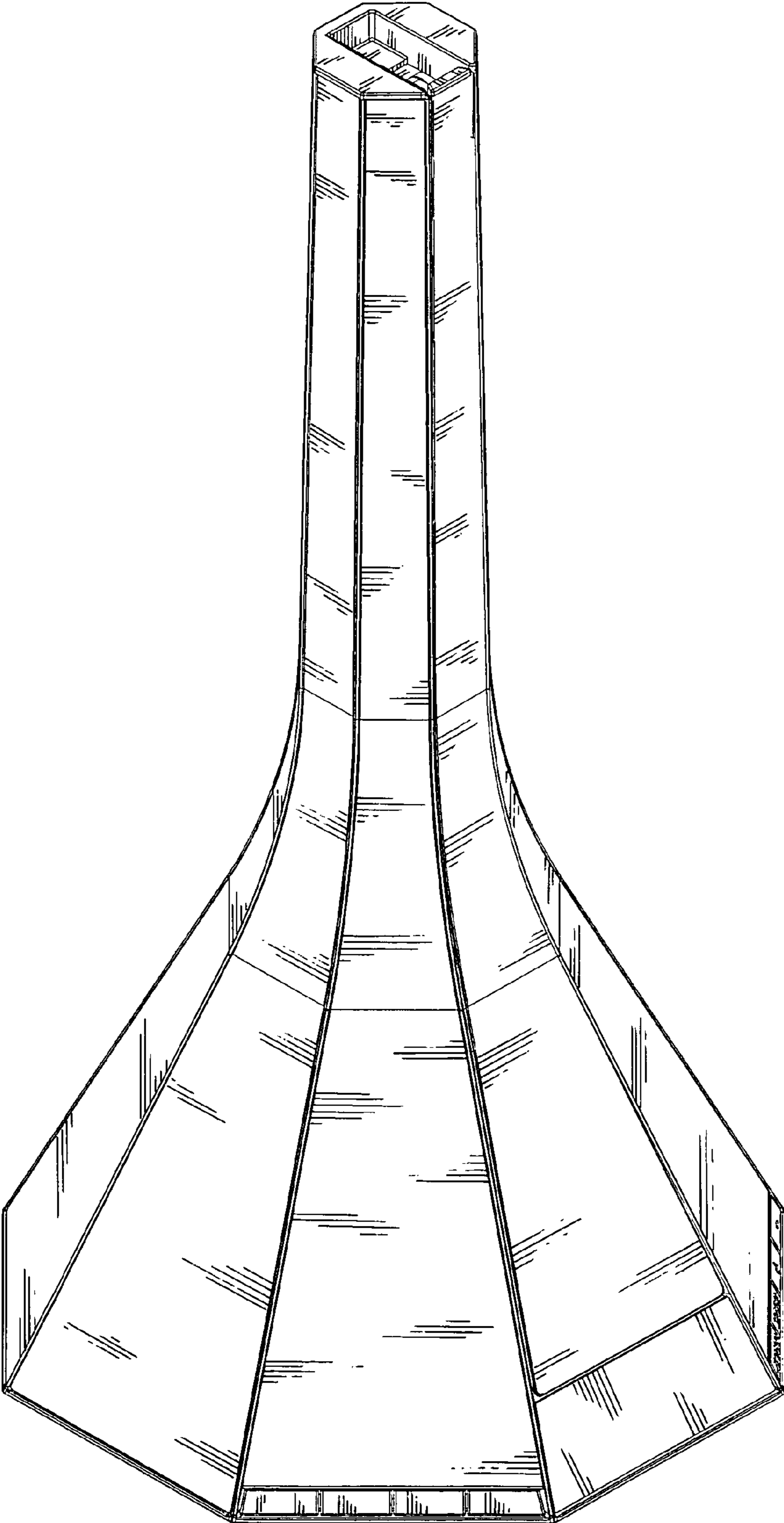

Fig. 1

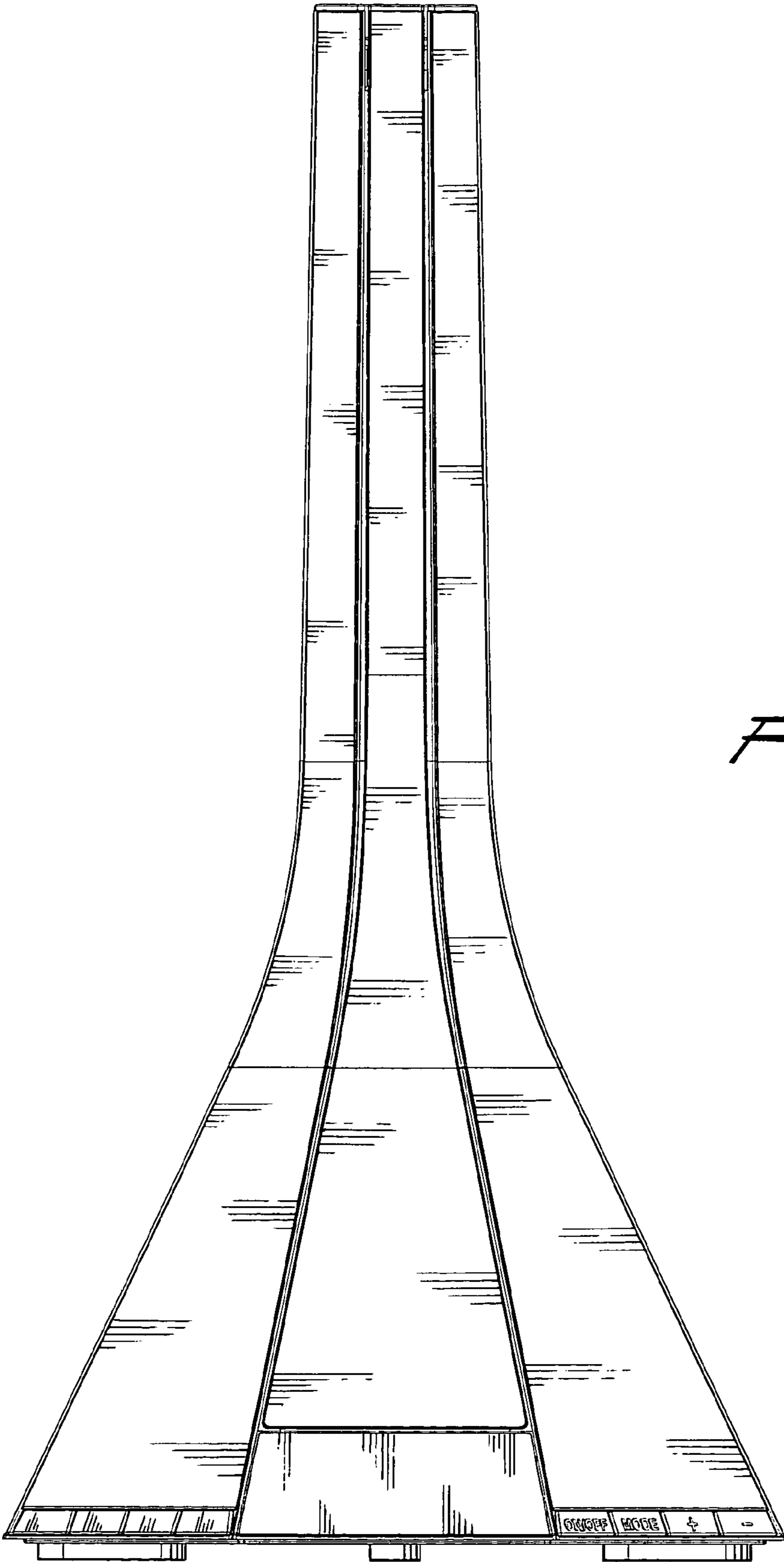

Fig. 2

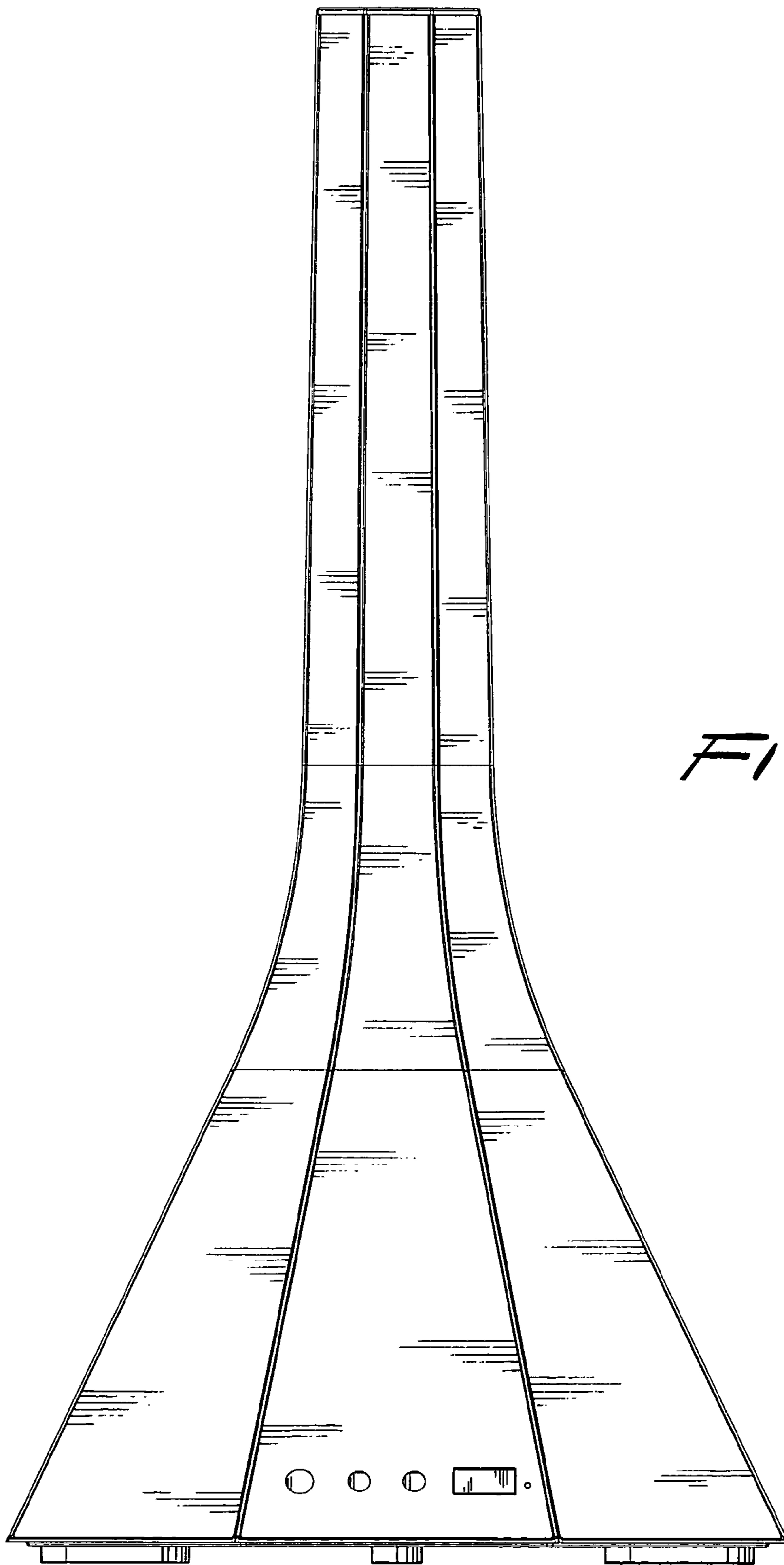

Fig. 3

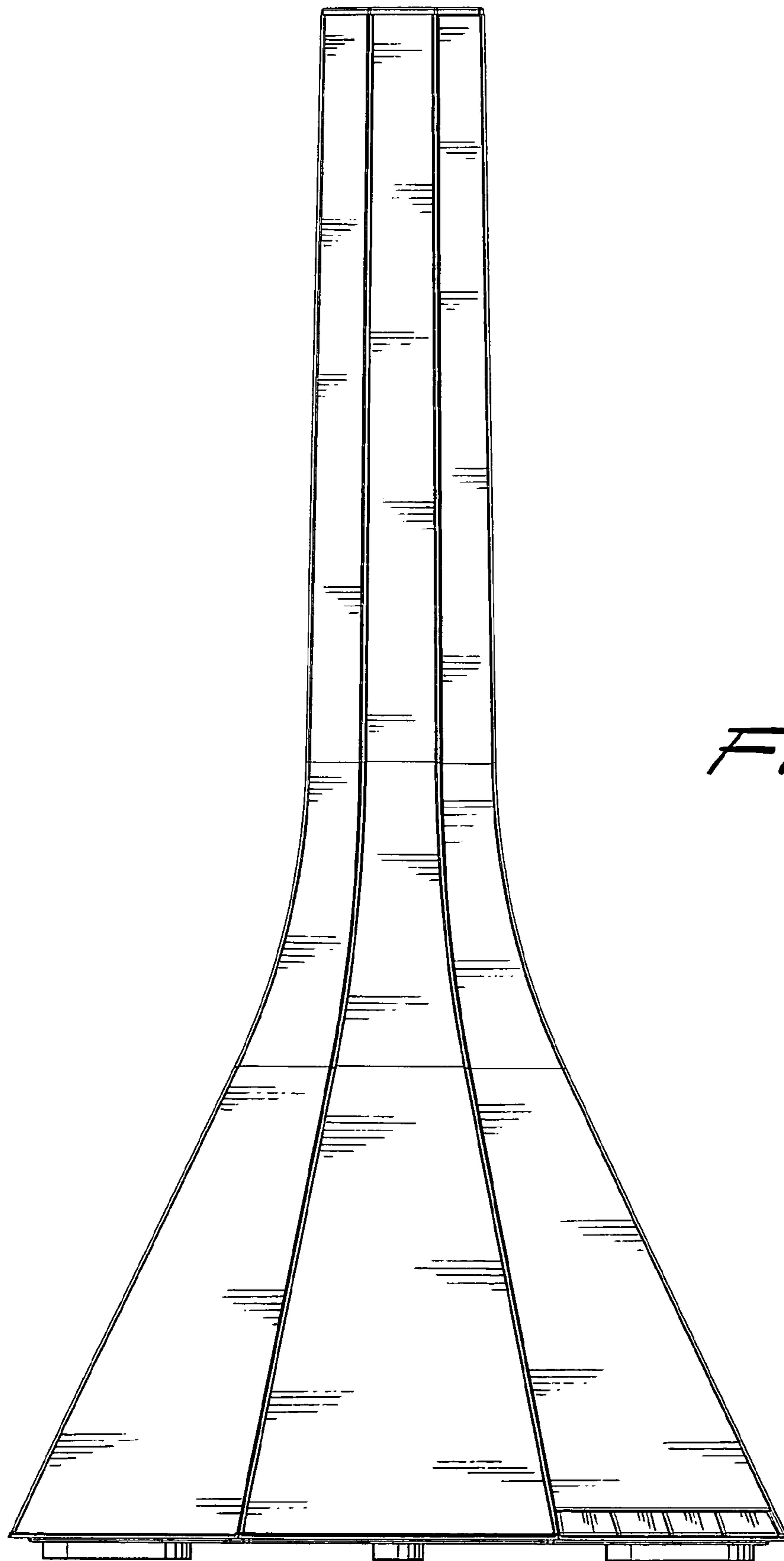

Fig. 4

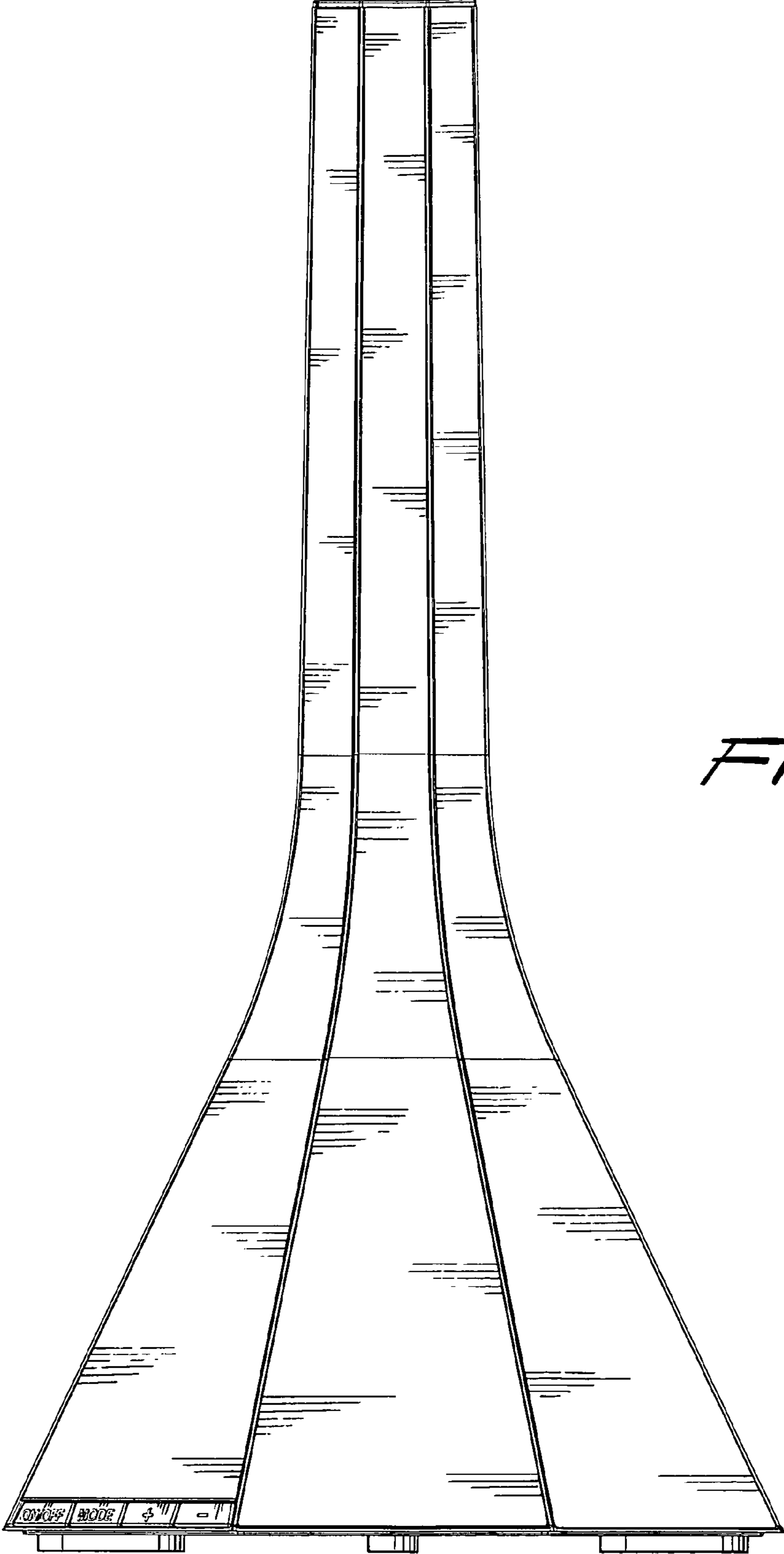

Fig. 5

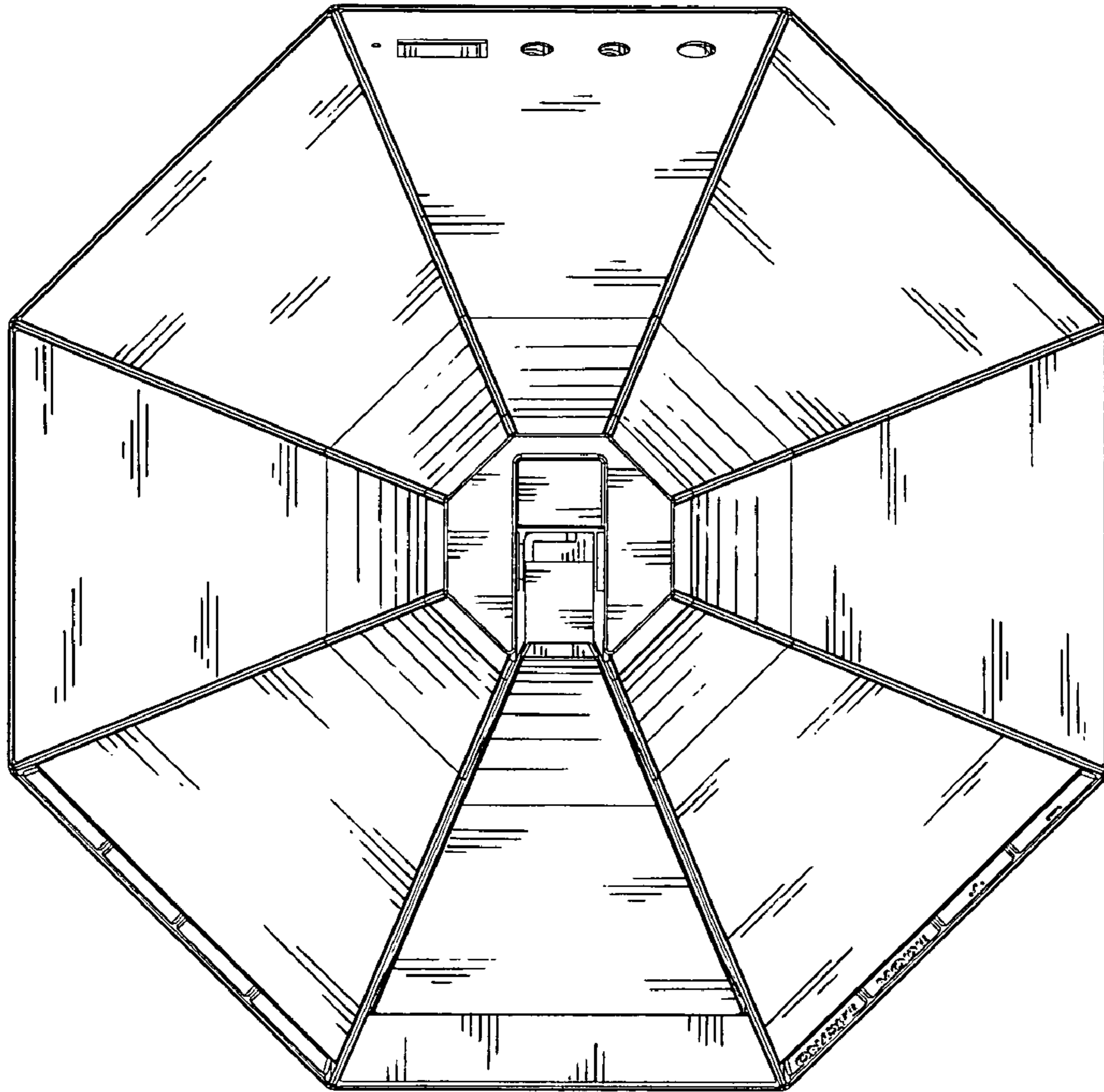

Fig. 6

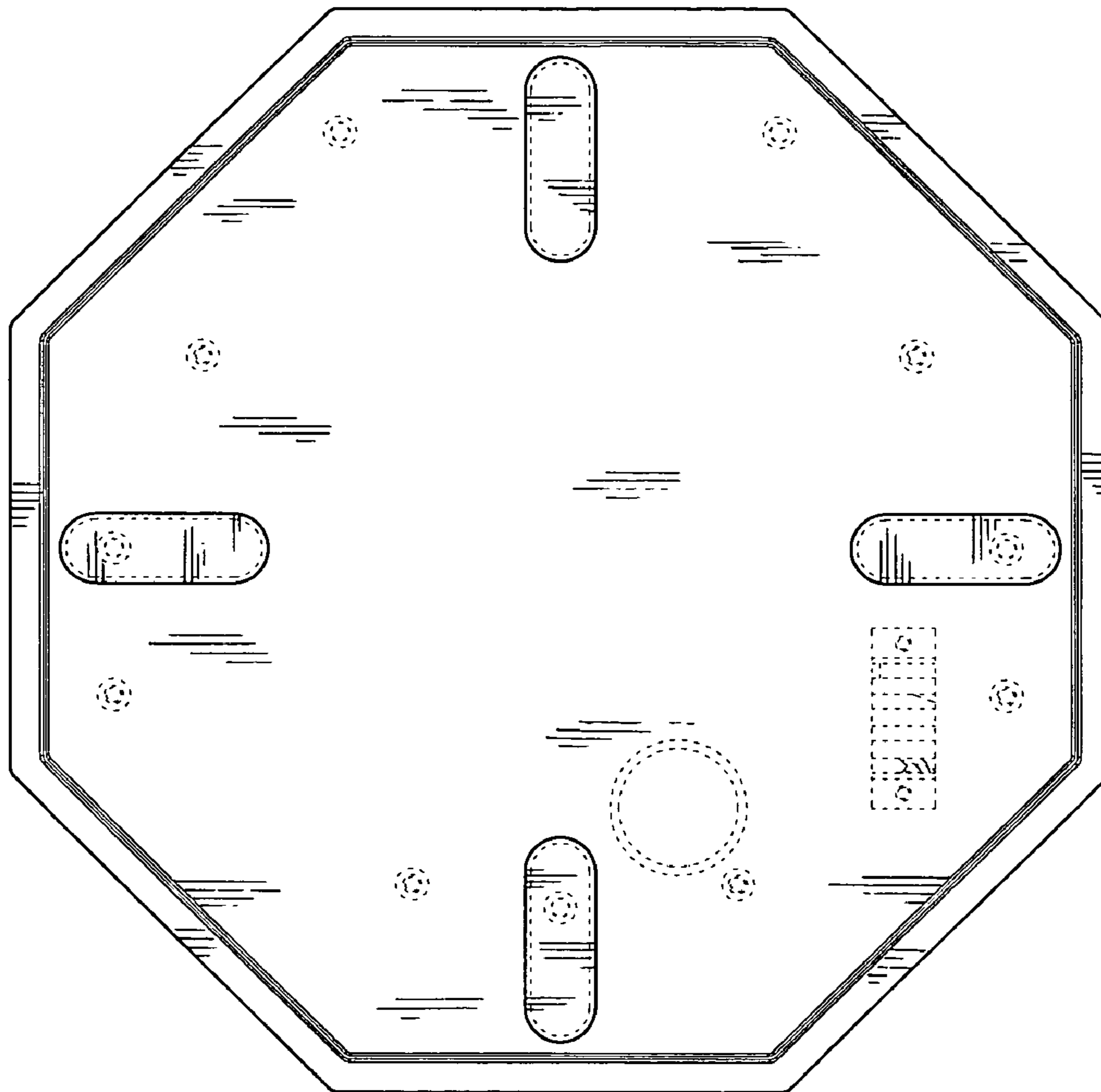

Fig. 7

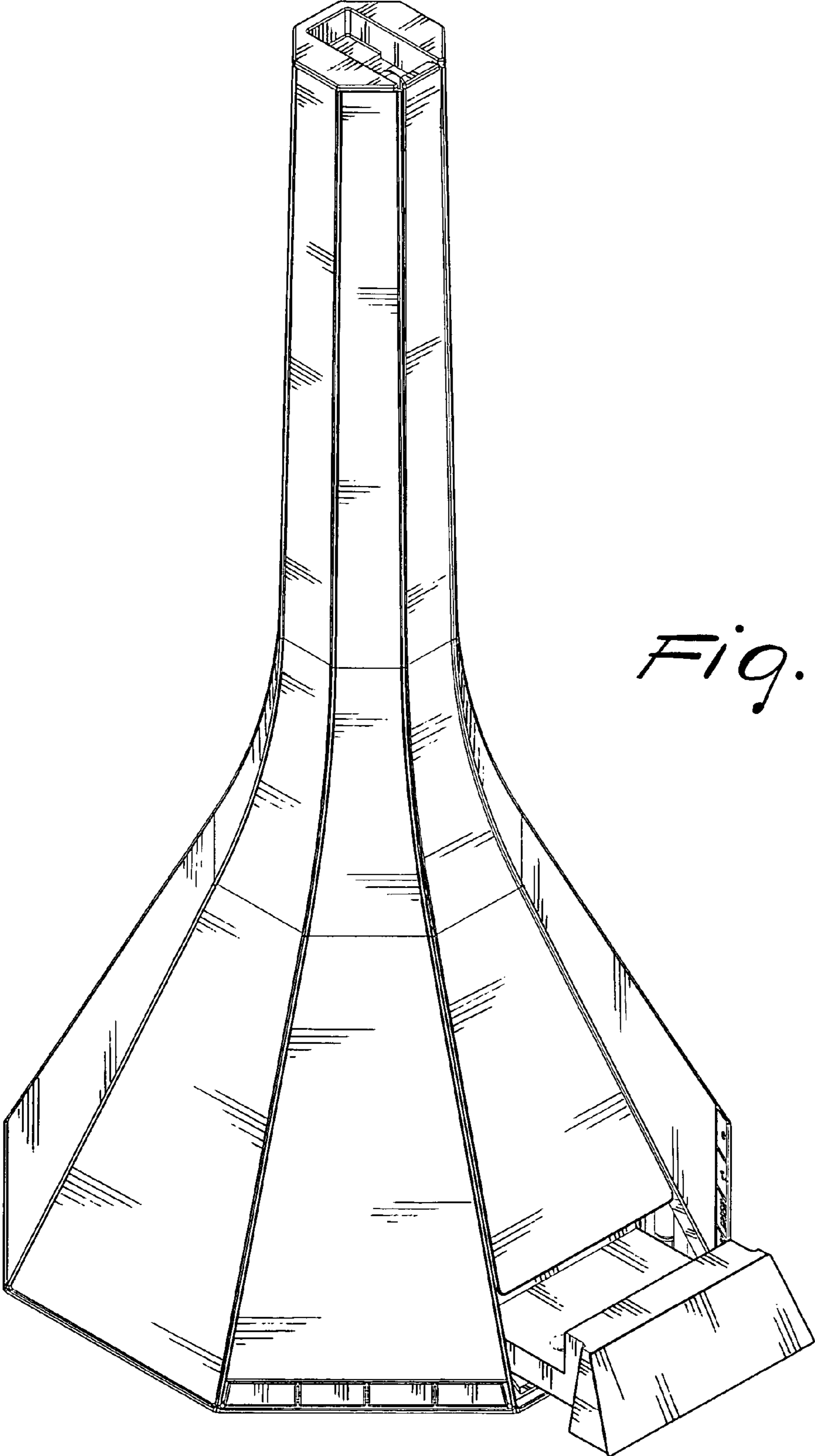

Fig. 8

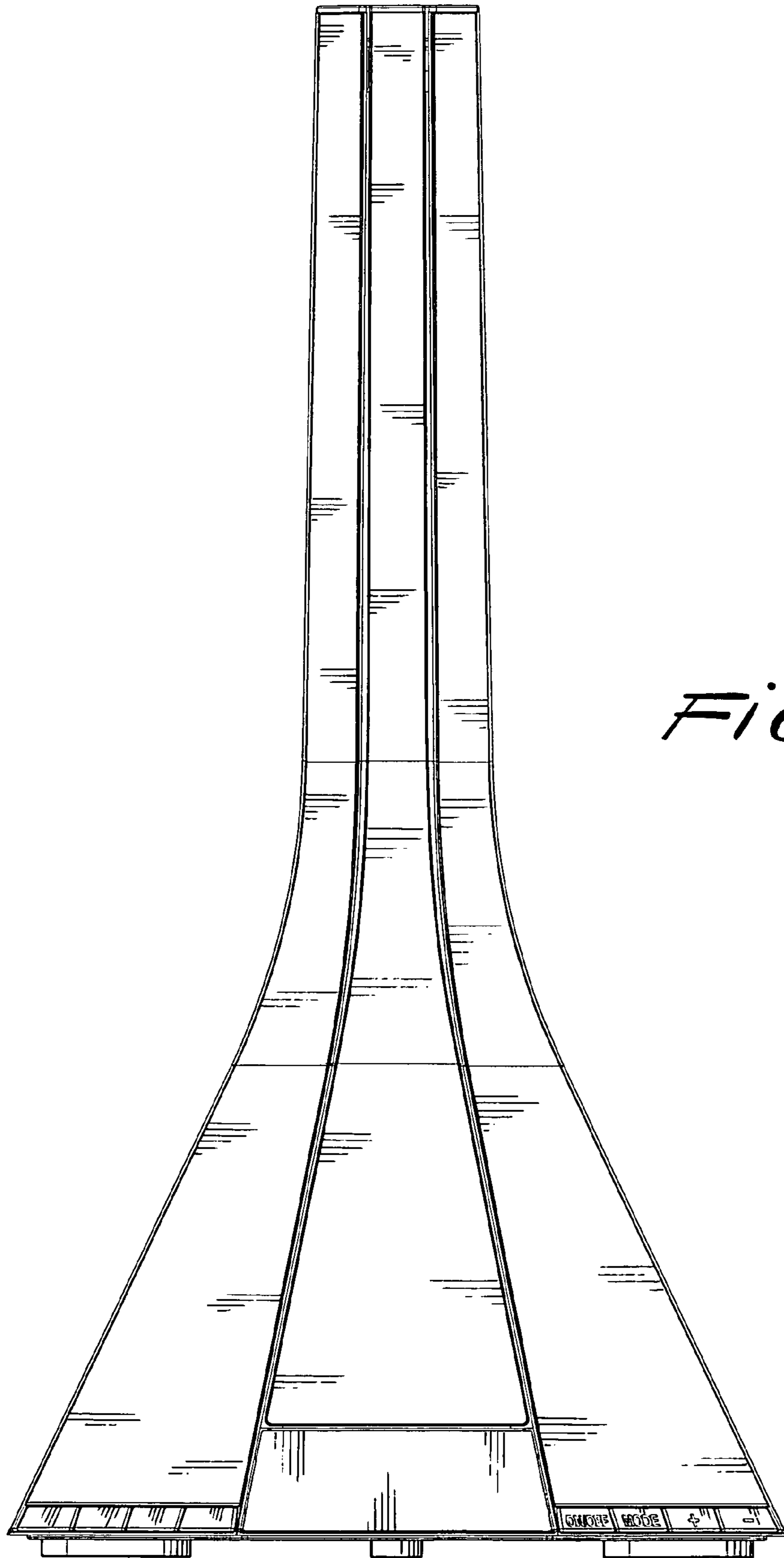

Fig. 9

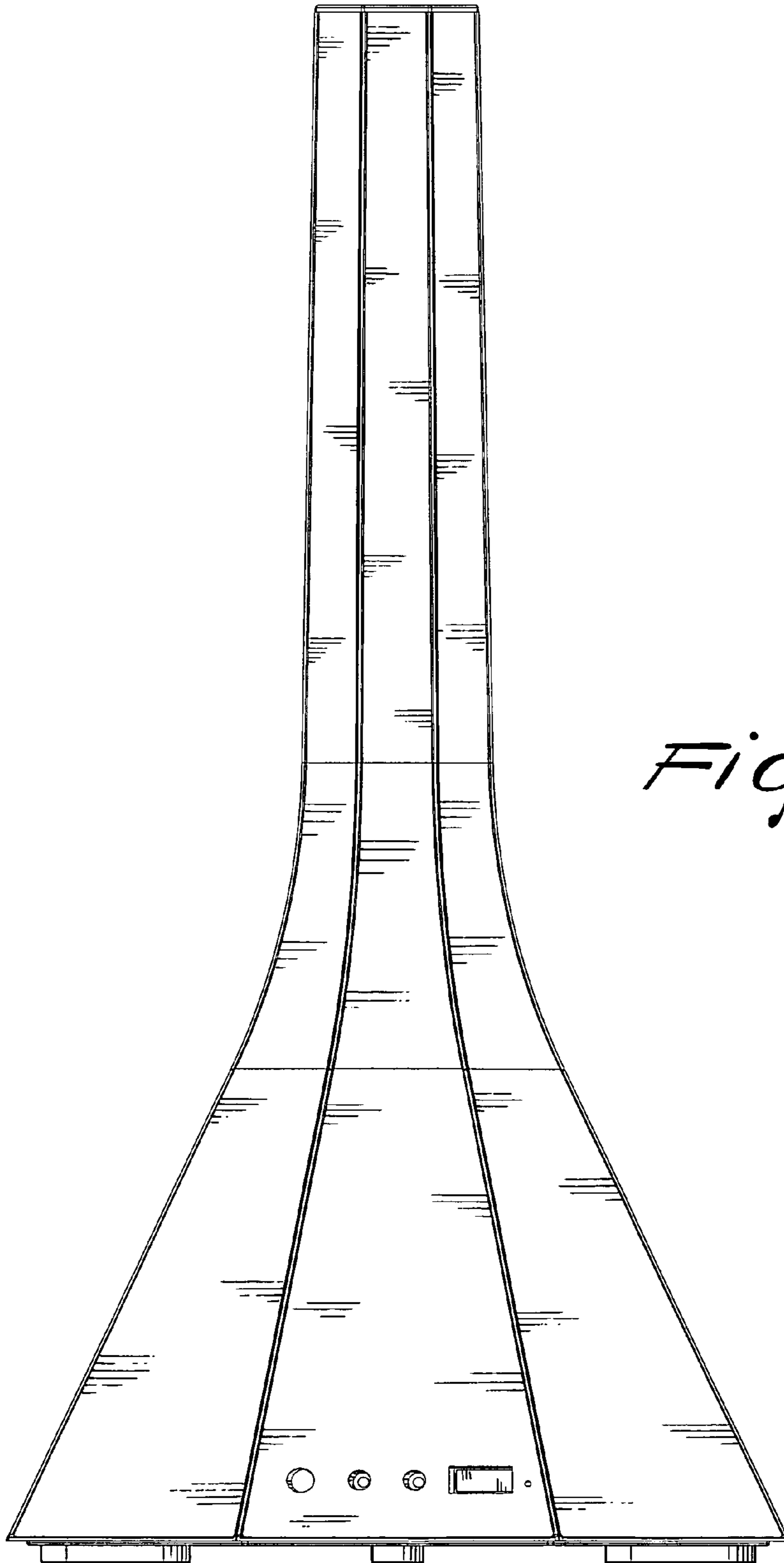

Fig. 10

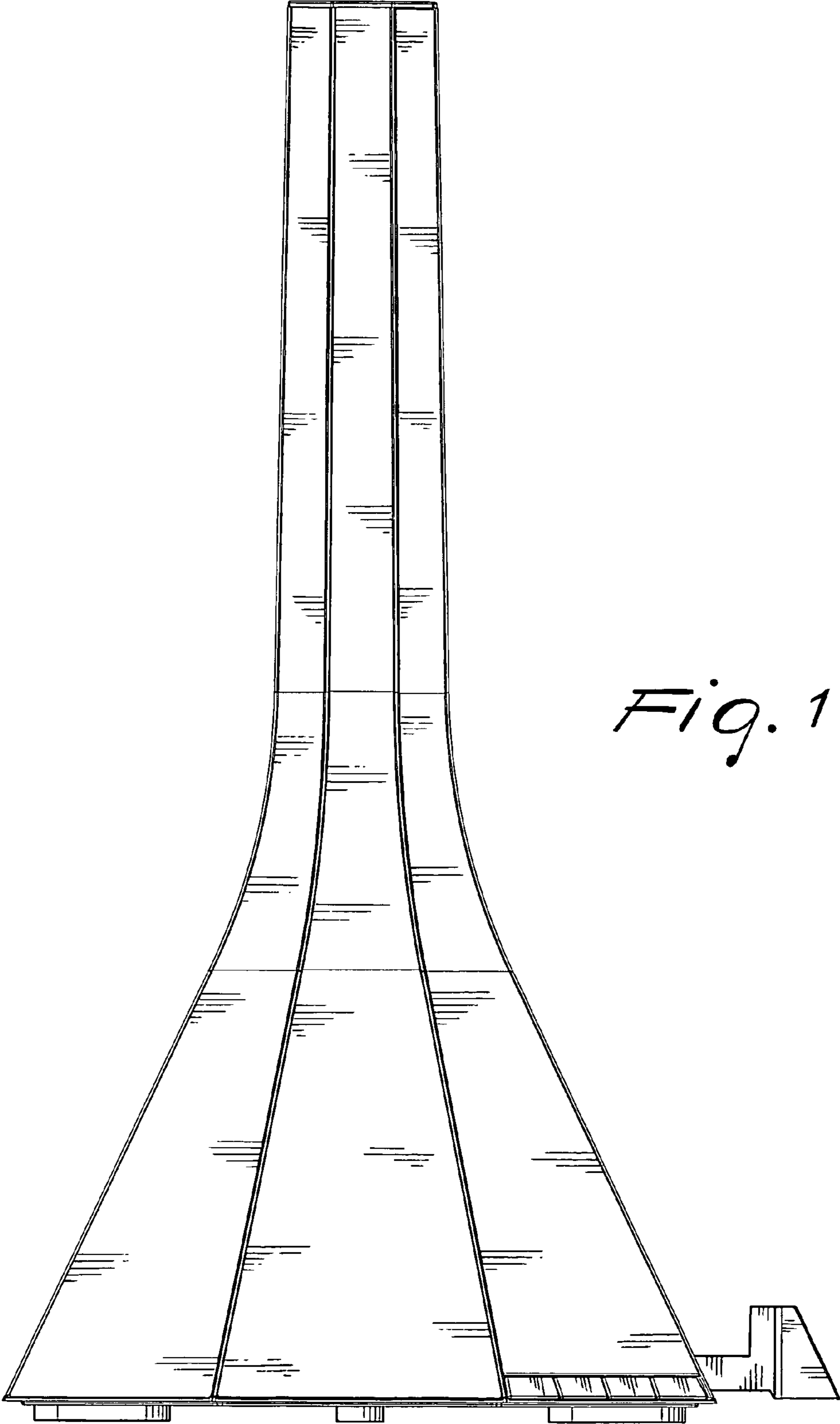

Fig. 11

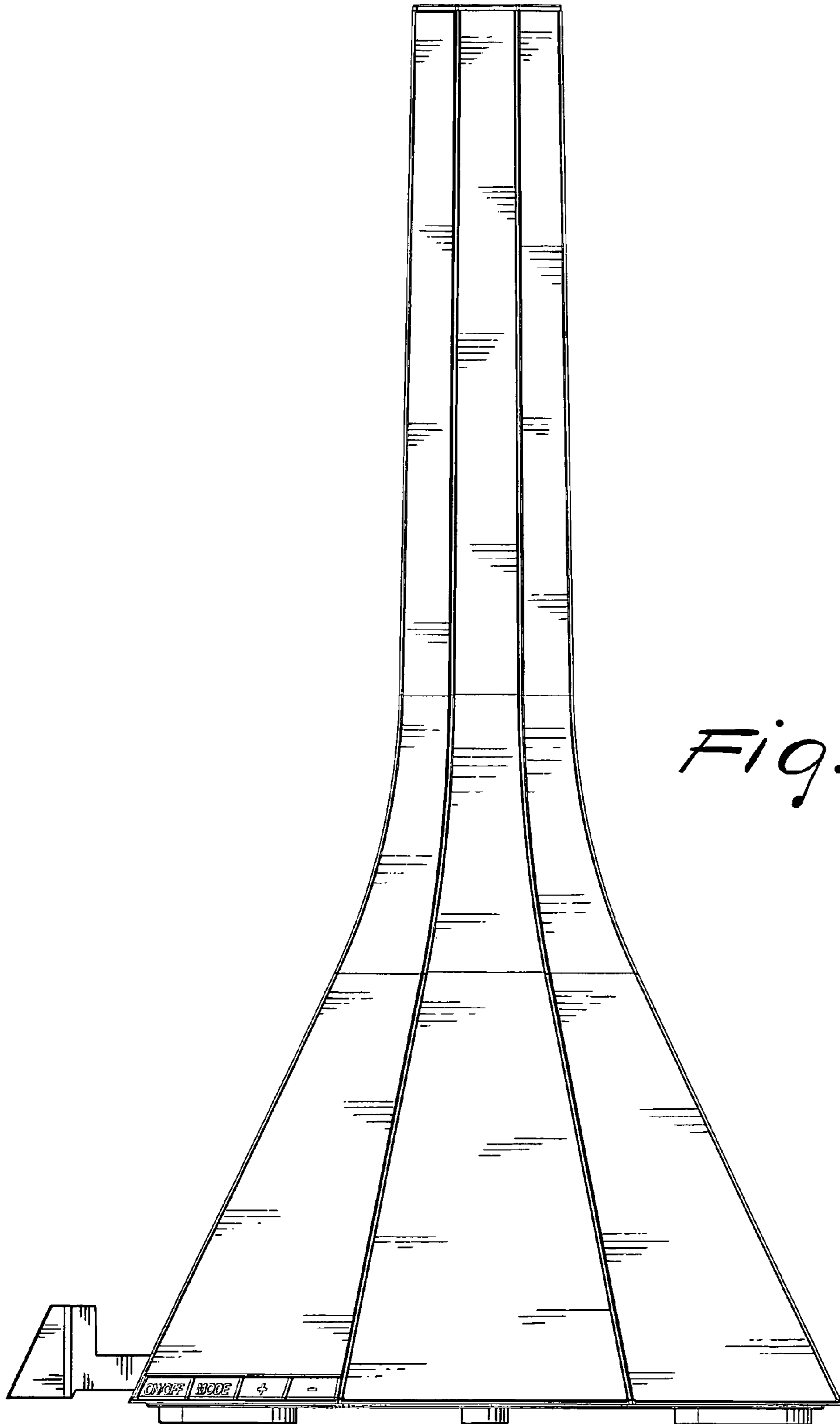

Fig. 12

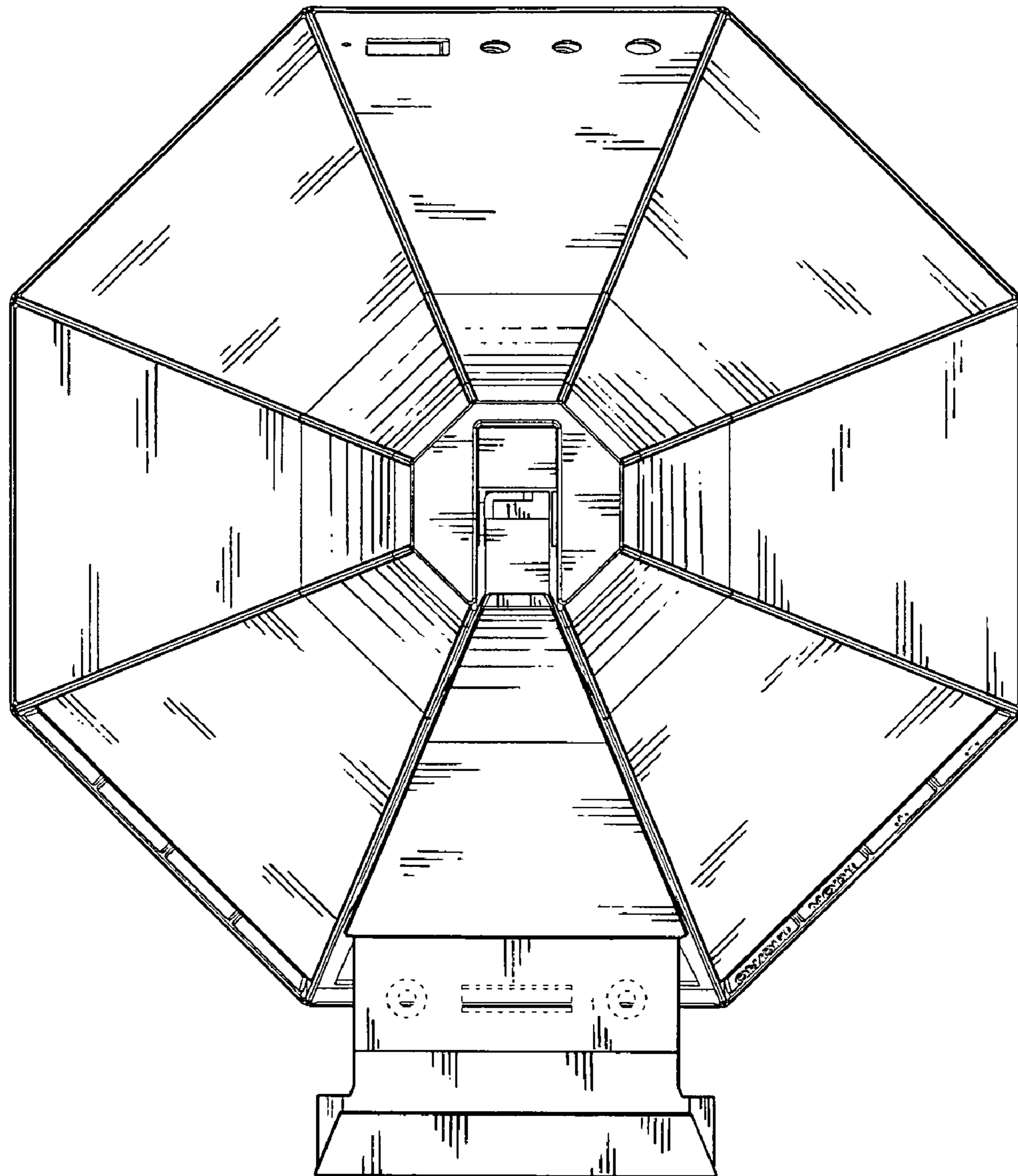

Fig. 13

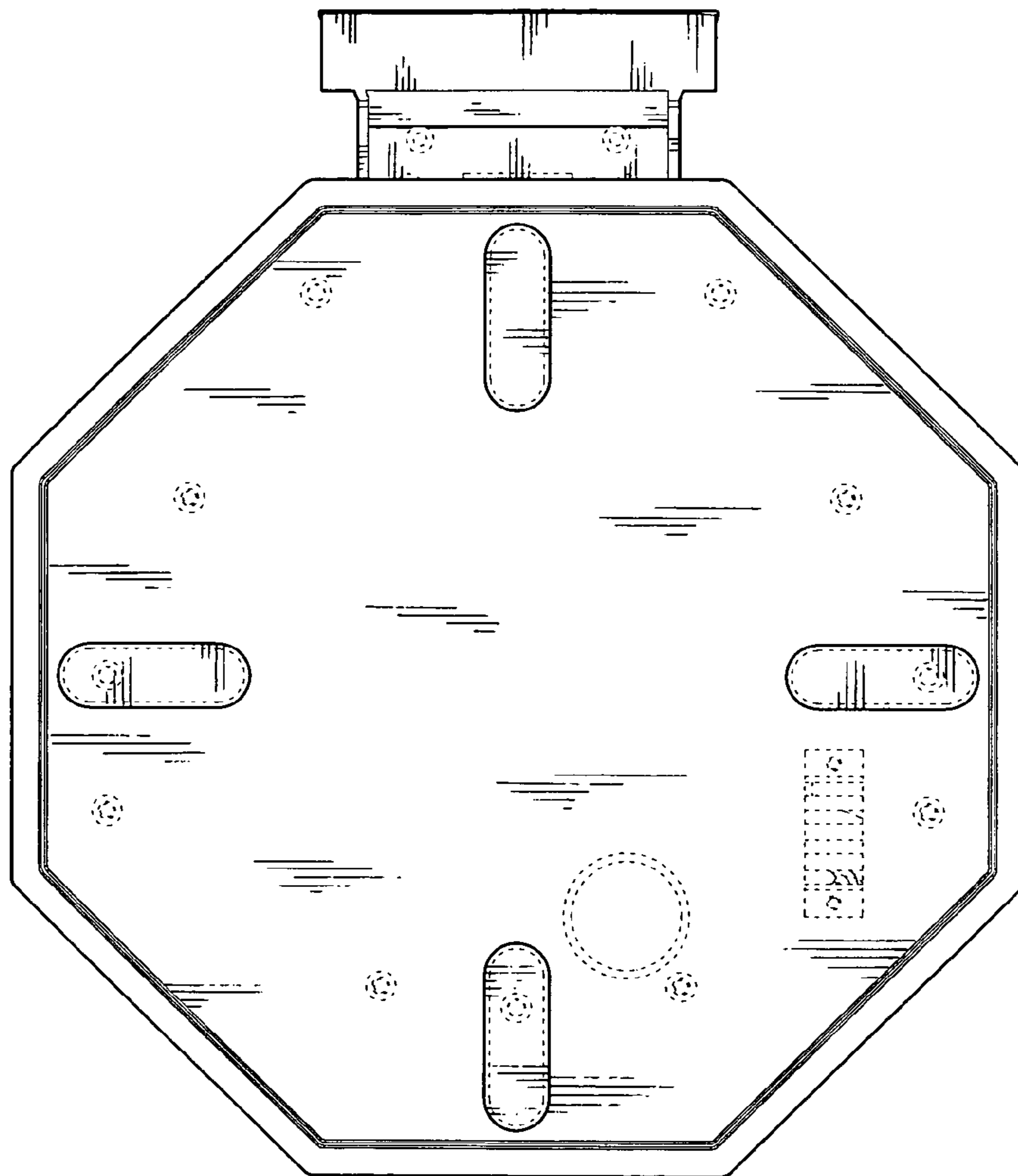

Fig. 14

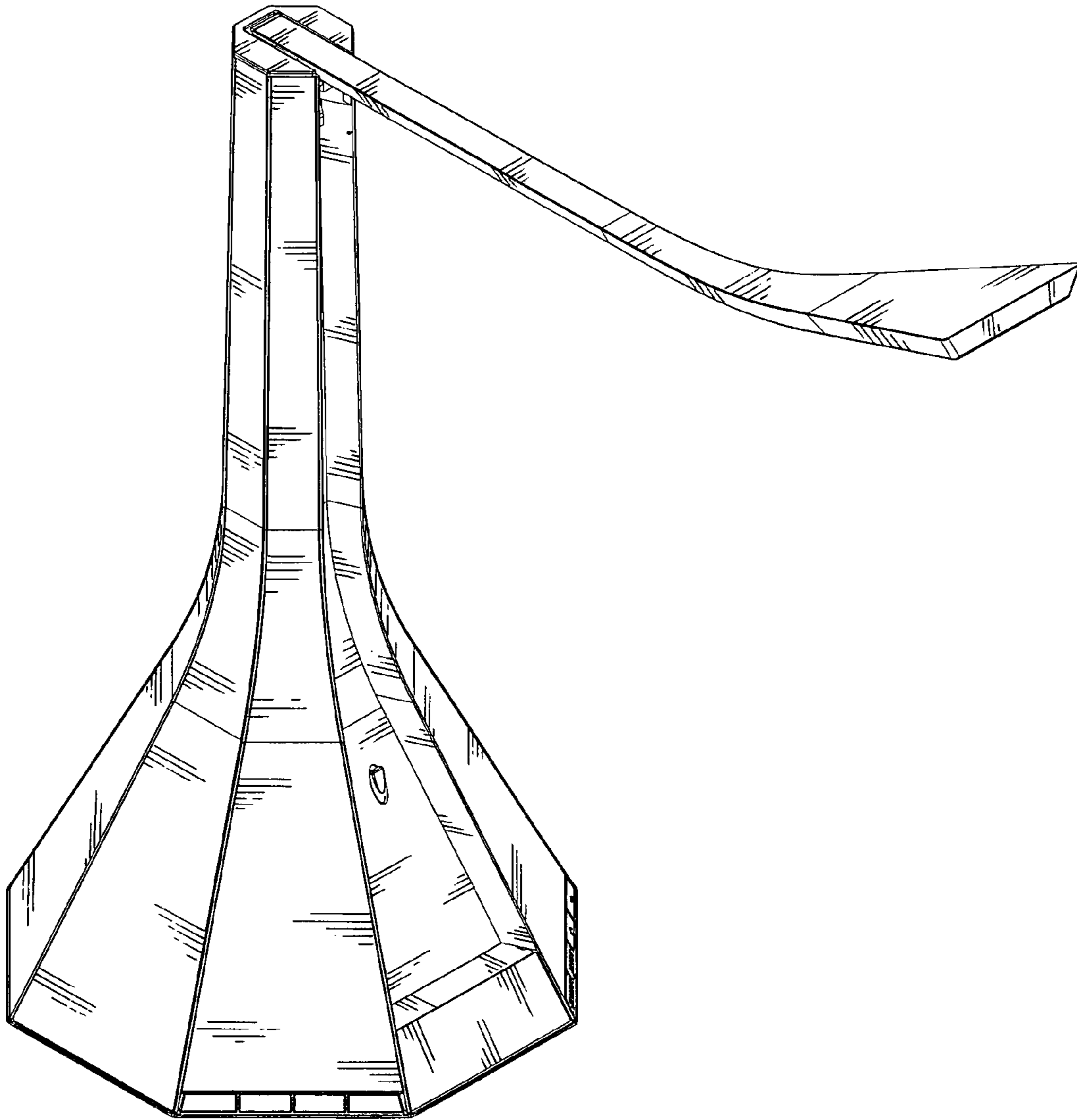

Fig. 15

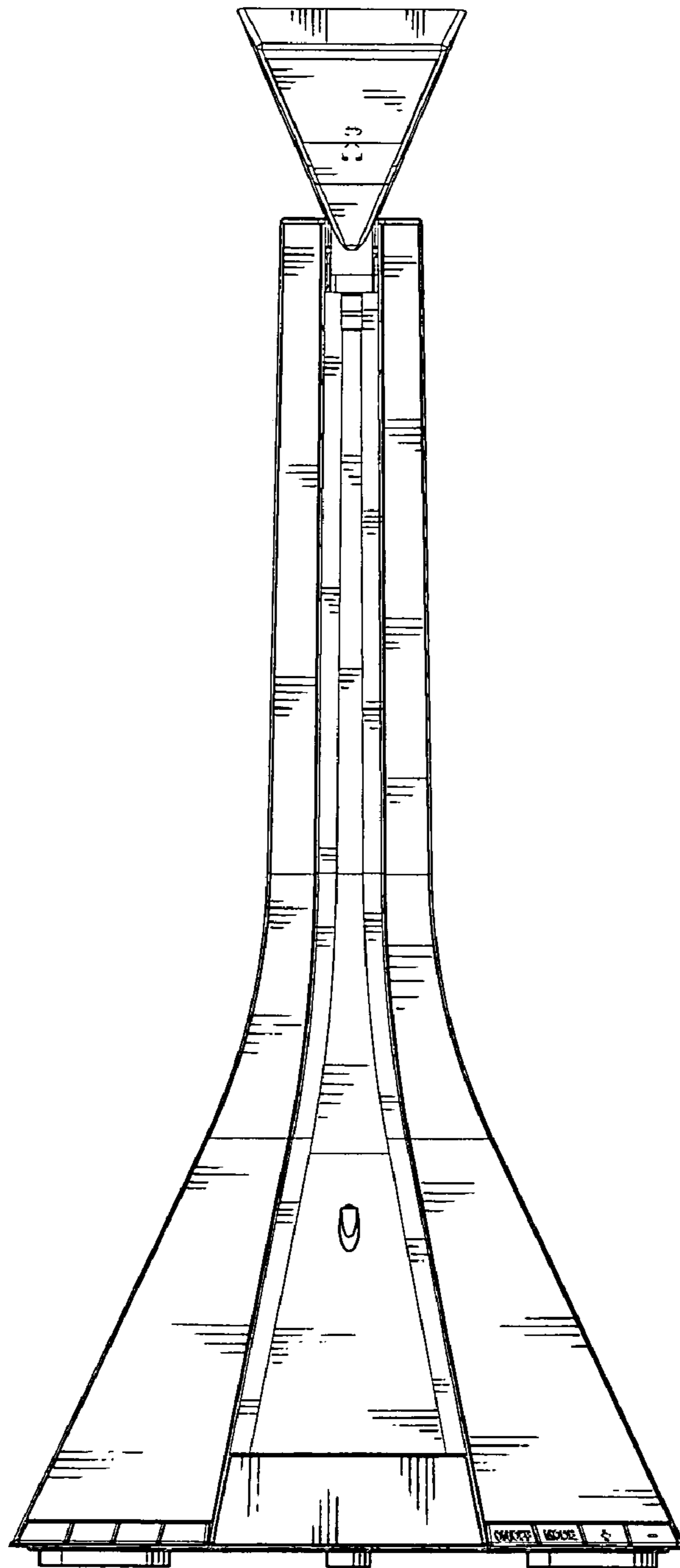

Fig. 16

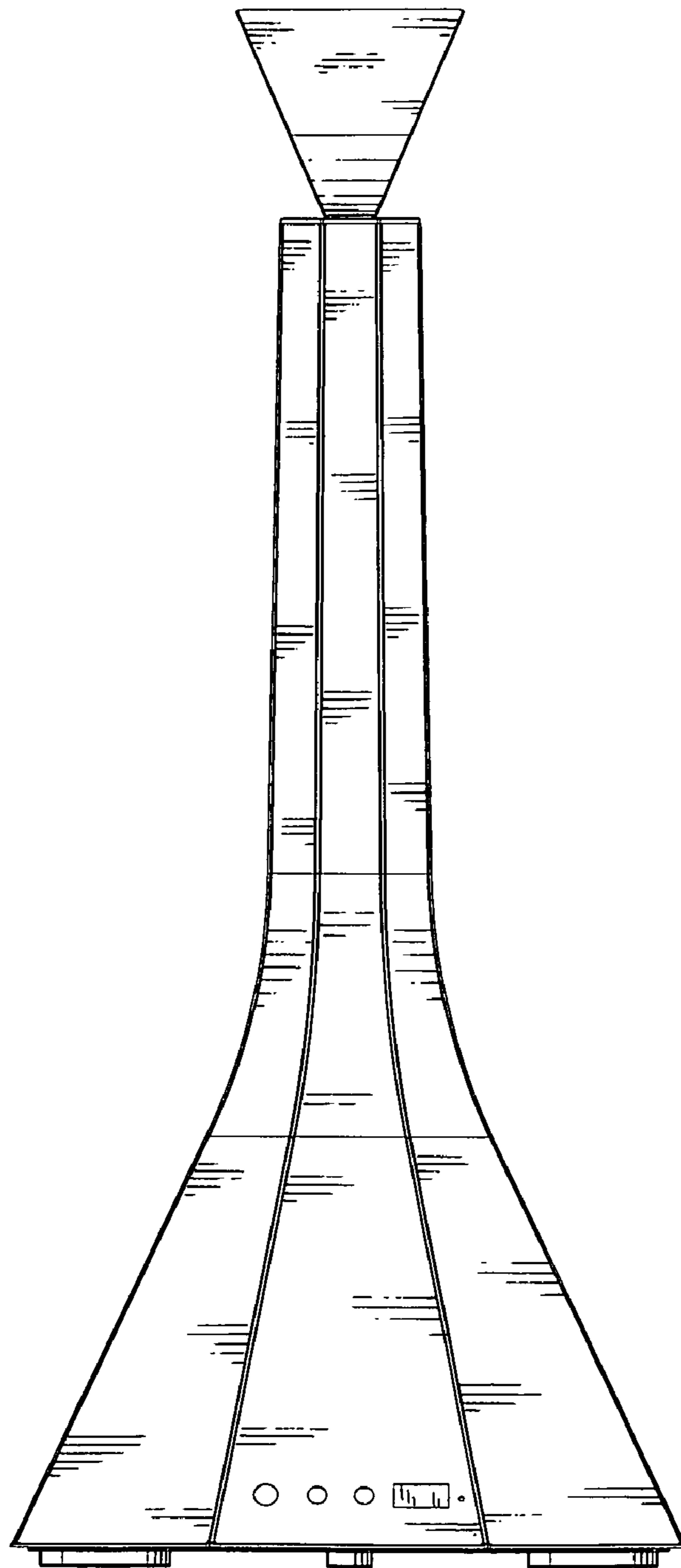

Fig. 17

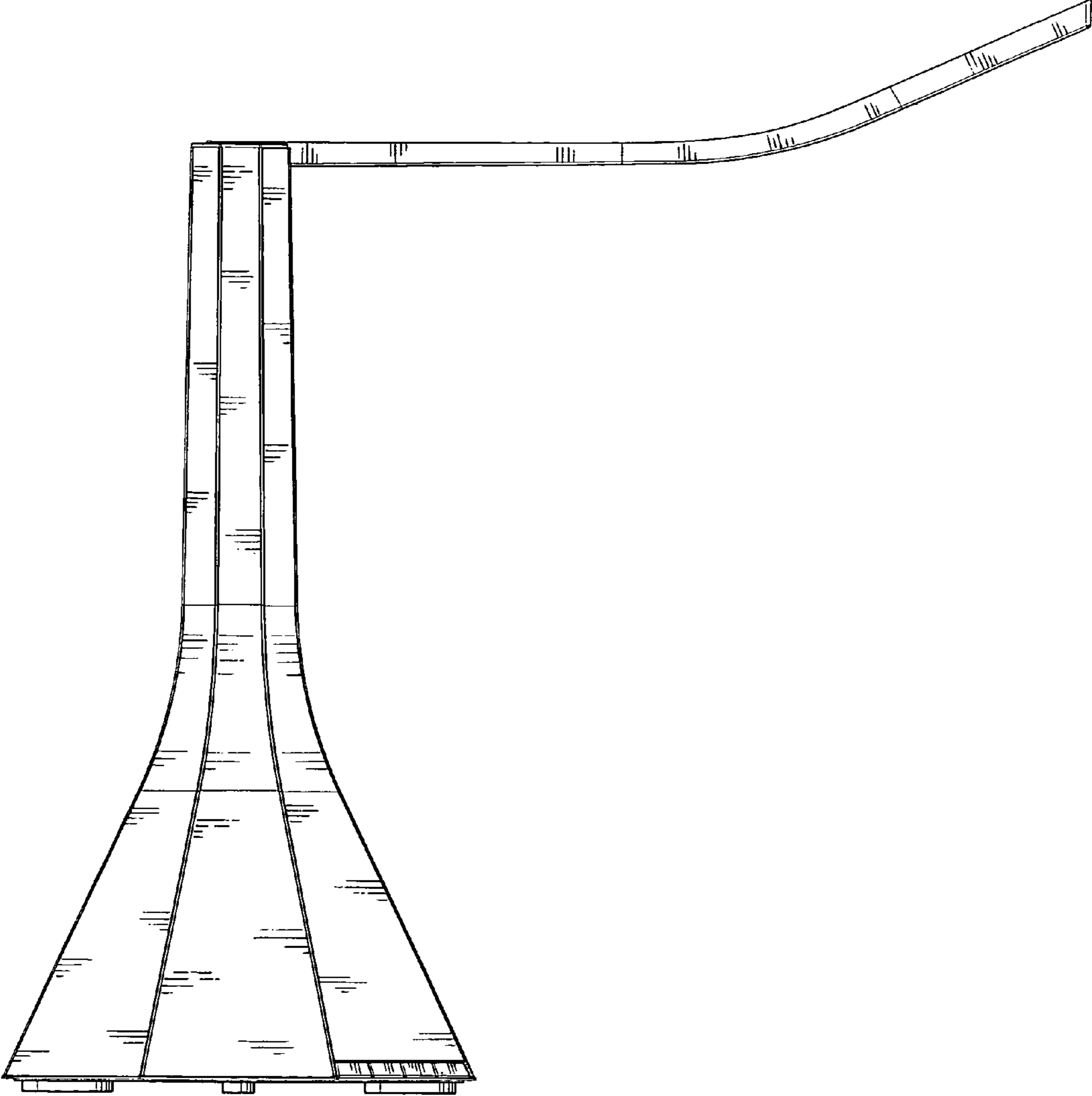

Fig. 18

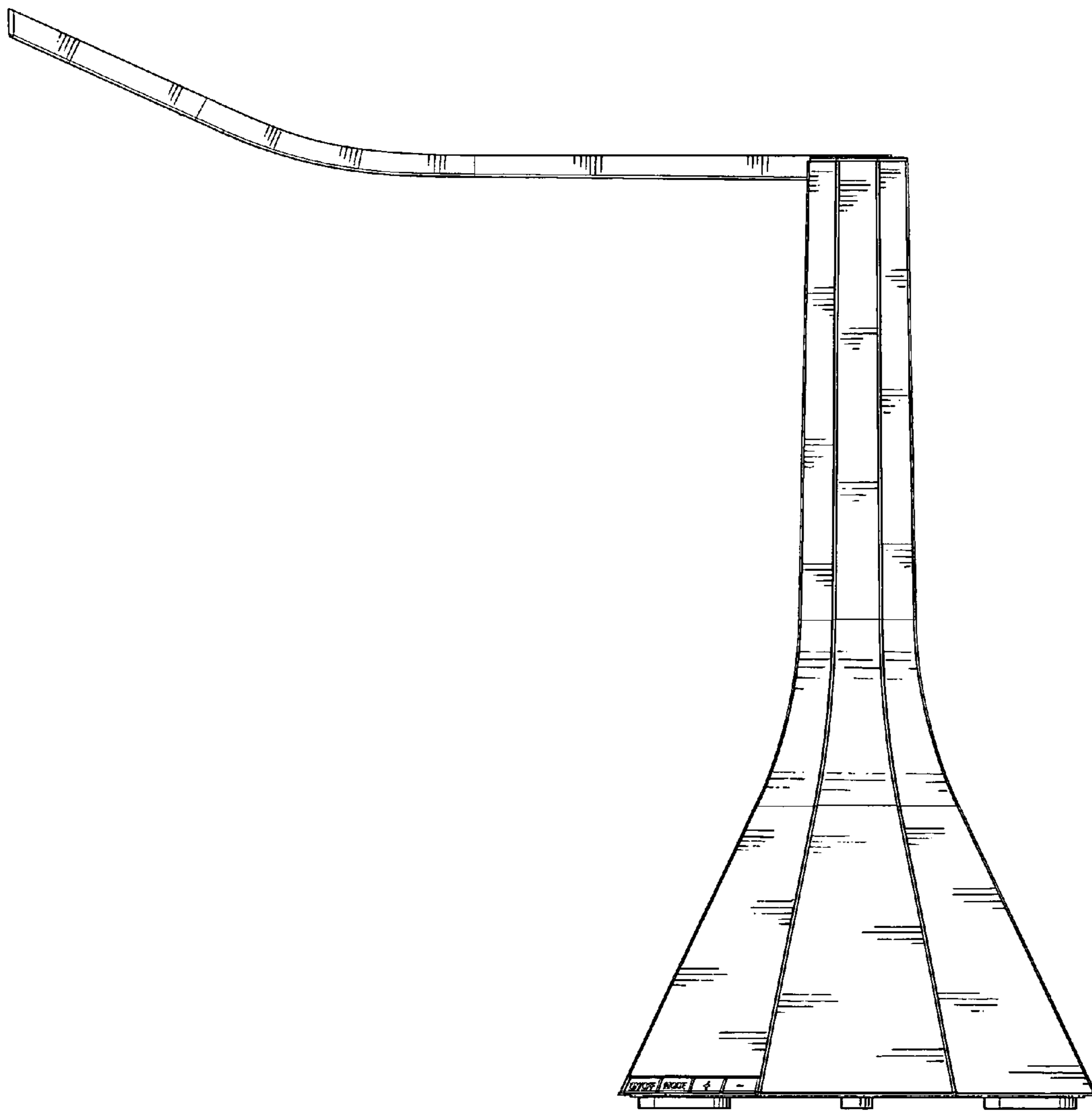

Fig. 19

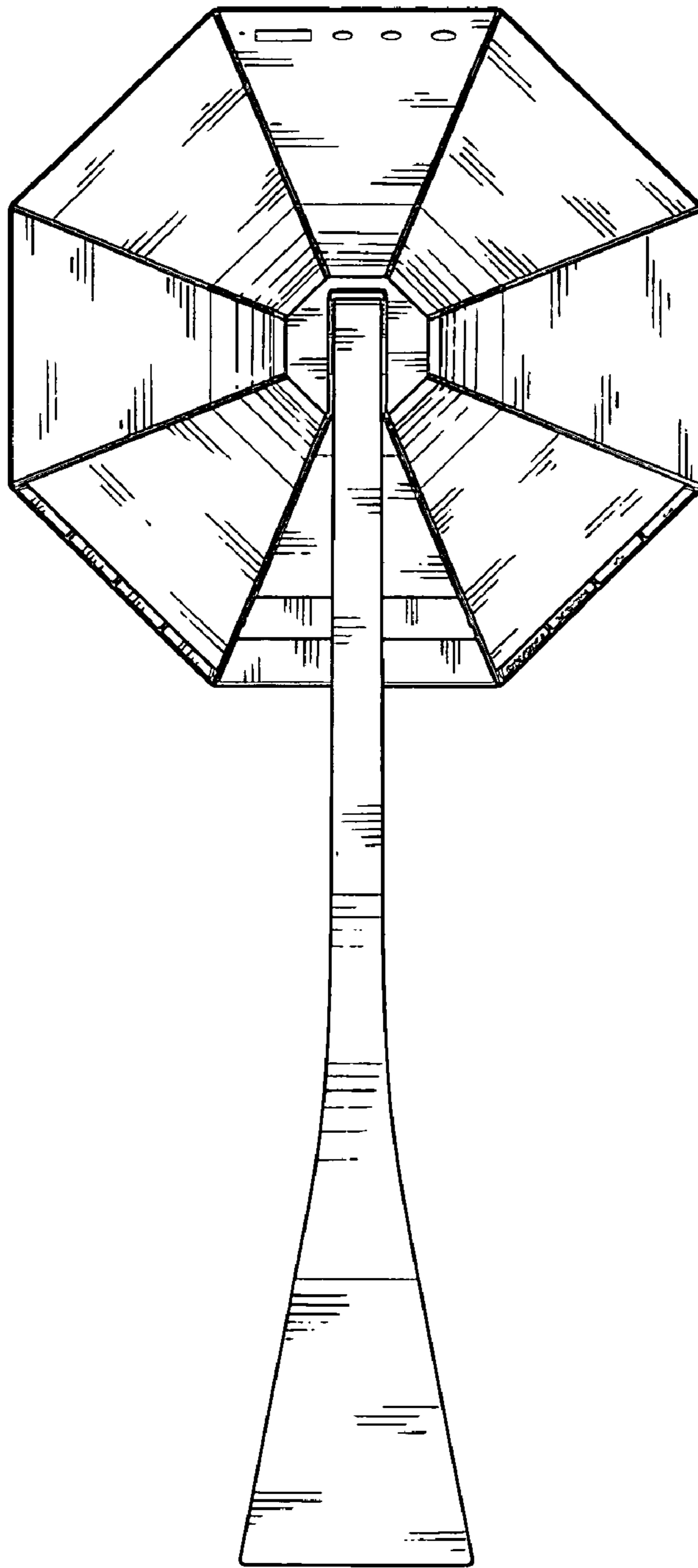

Fig. 20

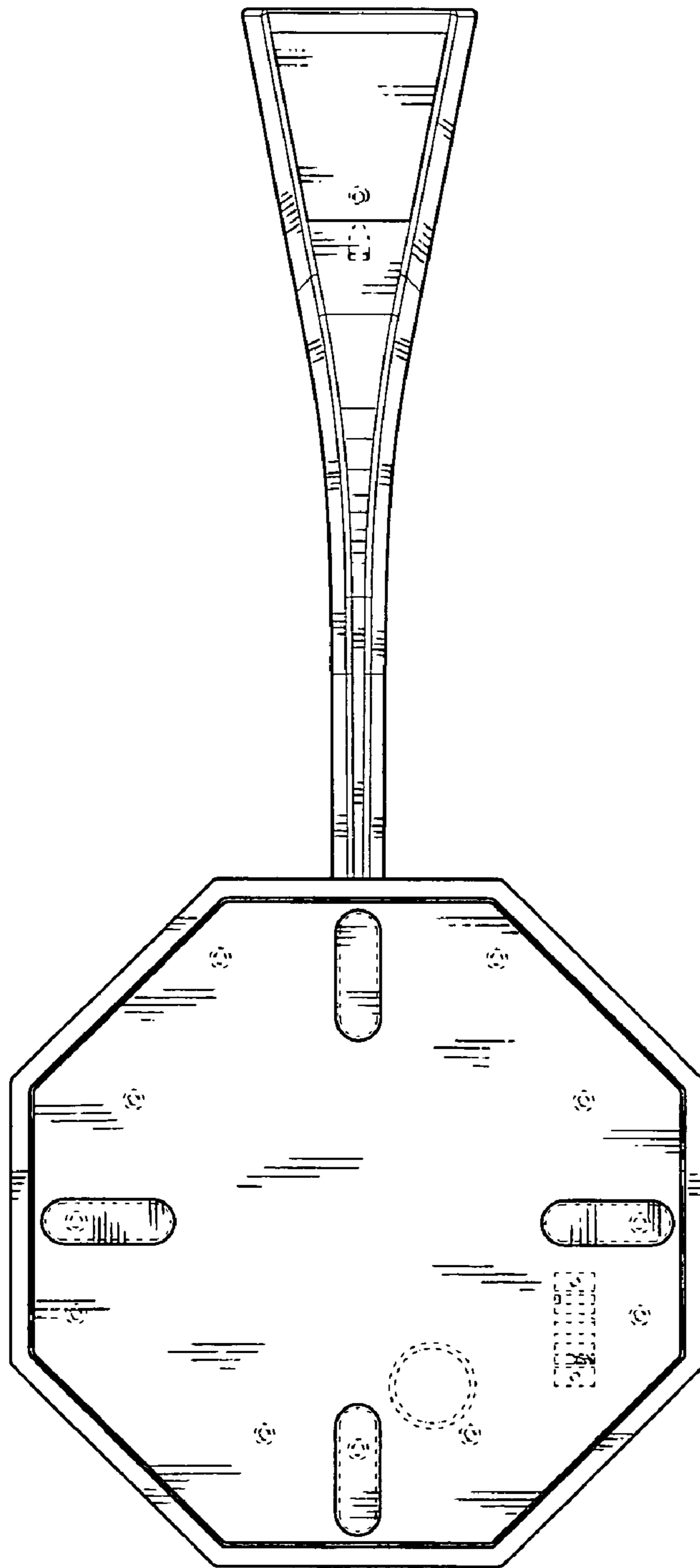

Fig. 21