



US00D628998S

(12) **United States Design Patent**  
**Wu et al.**

(10) **Patent No.:** **US D628,998 S**  
(45) **Date of Patent:** **\*\* Dec. 14, 2010**

(54) **KEYBOARD WITH INVISIBLE KEYS**  
(75) Inventors: **Kun-Tsan Wu**, Shindian (TW); **Li-Wen Tien**, Shindian (TW)  
(73) Assignee: **FIH (Hong Kong) Limited**, Kowloon (HK)

6,705,787 B2 \* 3/2004 Jeffries et al. .... 400/714  
D501,478 S \* 2/2005 Tzeng et al. .... D14/396  
D528,117 S \* 9/2006 Shimizu ..... D14/391  
7,254,012 B2 \* 8/2007 Chou ..... 361/679.09  
D569,376 S \* 5/2008 Shimizu ..... D14/391  
D579,450 S \* 10/2008 Ozolins et al. .... D14/391  
D601,568 S \* 10/2009 Kujawski ..... D14/455

(\*\*) Term: **14 Years**  
(21) Appl. No.: **29/354,964**

\* cited by examiner  
*Primary Examiner*—Freda S Nunn  
(74) *Attorney, Agent, or Firm*—Steven M. Reiss

(22) Filed: **Feb. 1, 2010**

(57) **CLAIM**

(30) **Foreign Application Priority Data**  
Dec. 28, 2009 (CN) ..... 2009 3 0331642

The ornamental design for a keyboard with invisible keys, as shown and described.

(51) **LOC (9) Cl.** ..... **14-02**  
(52) **U.S. Cl.** ..... **D14/391; D14/455**  
(58) **Field of Classification Search** ..... D14/390–399, D14/455; D18/1, 2, 7; 178/17 A, 17 C; 200/5 A, 200/5 R, 6 A, 6 R; 235/145 A, 145 R; 345/160, 345/168, 169, 173; 341/22, 23; 400/484–489, 400/492; 361/679.08, 679.09, 679.11–679.13  
See application file for complete search history.

**DESCRIPTION**

FIG. 1 is a perspective view of a keyboard with invisible keys showing our new design;  
FIG. 2 is a front elevational view thereof;  
FIG. 3 is a rear elevational view thereof;  
FIG. 4 is a left side elevational view thereof;  
FIG. 5 is a right side elevational view thereof;  
FIG. 6 is a top plan view thereof;  
FIG. 7 is a bottom plan view thereof; and,  
FIG. 8 is a perspective view thereof when in a use.  
The broken lines of FIG. 8 are for showing environmental features and are not part of the design.

(56) **References Cited**  
U.S. PATENT DOCUMENTS  
D279,474 S \* 7/1985 Akagi et al. .... D14/396  
D320,597 S \* 10/1991 Lacount et al. .... D14/396  
D353,369 S \* 12/1994 Leibengood ..... D14/455  
5,439,304 A \* 8/1995 Phillips et al. .... 400/492  
D440,969 S \* 4/2001 Tsai ..... D14/392

**1 Claim, 8 Drawing Sheets**

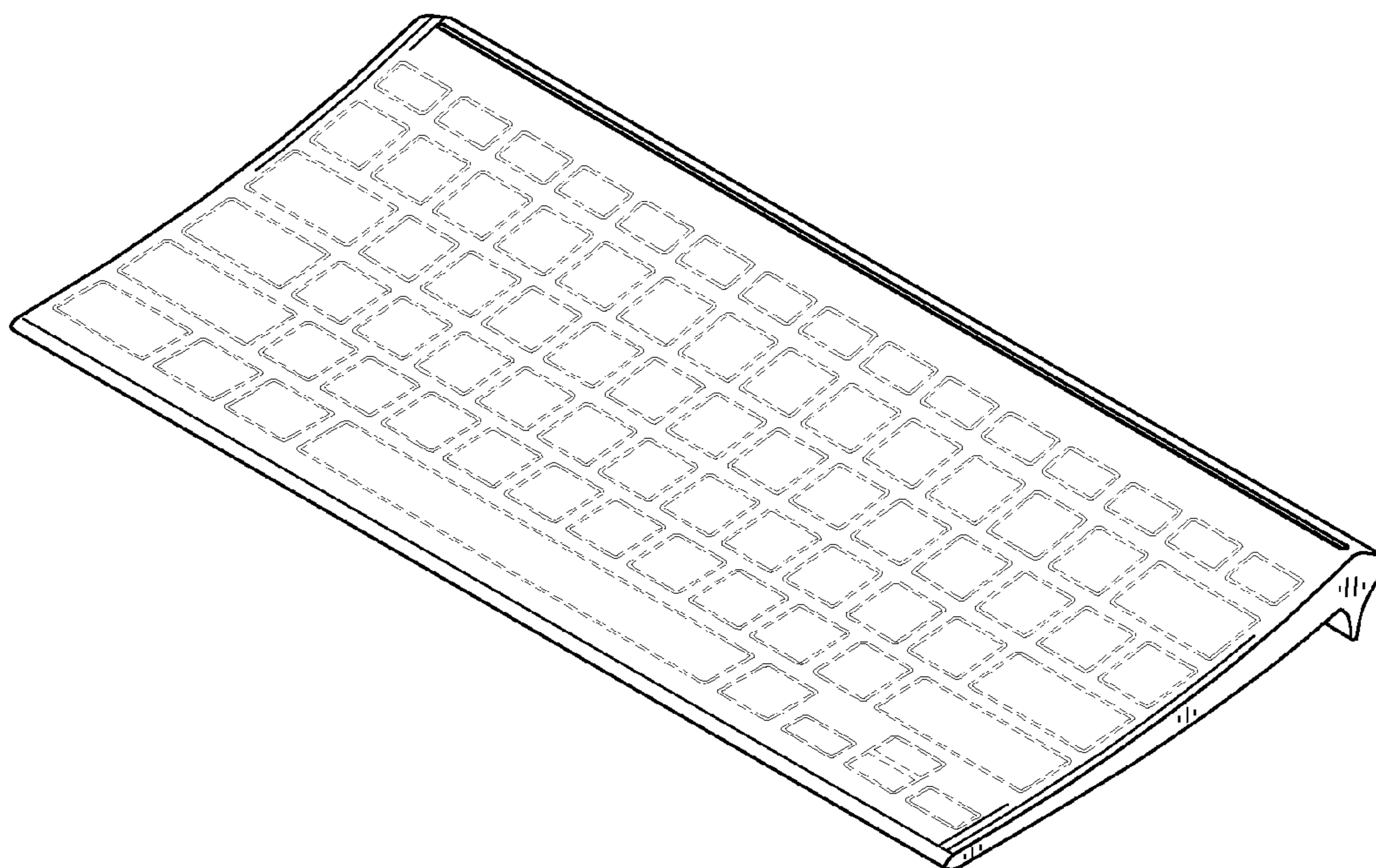

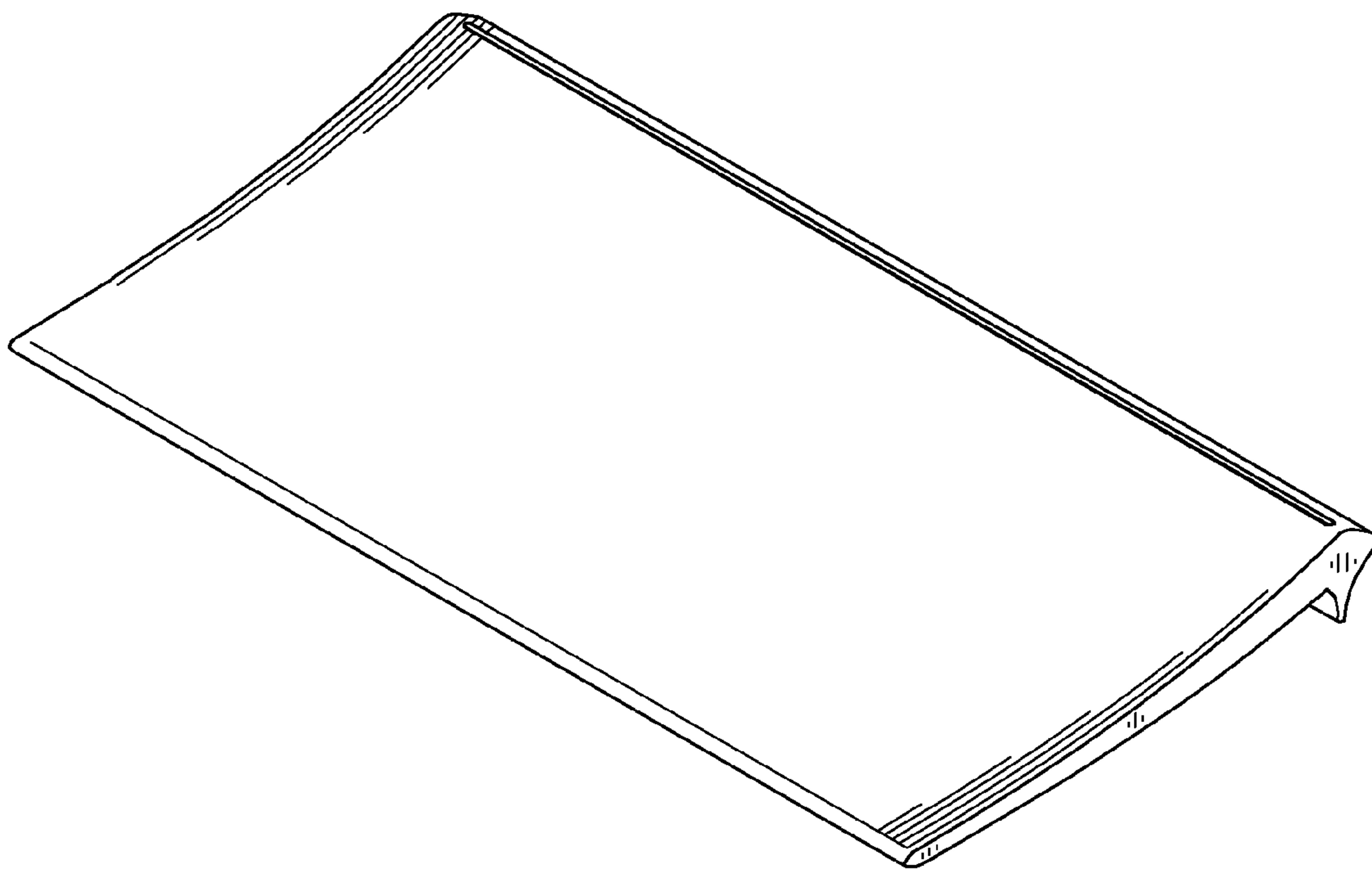

FIG. 1

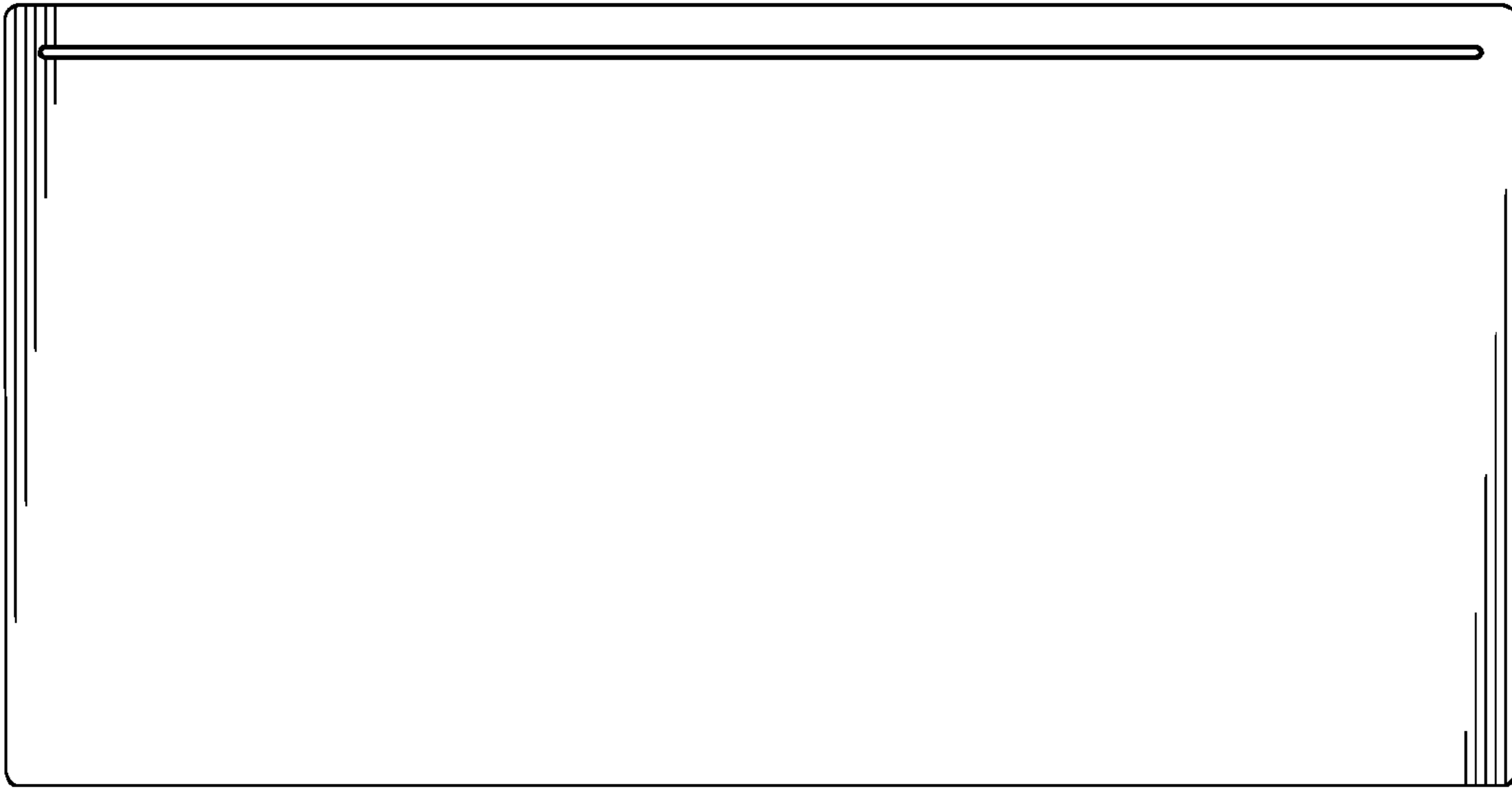

FIG. 2

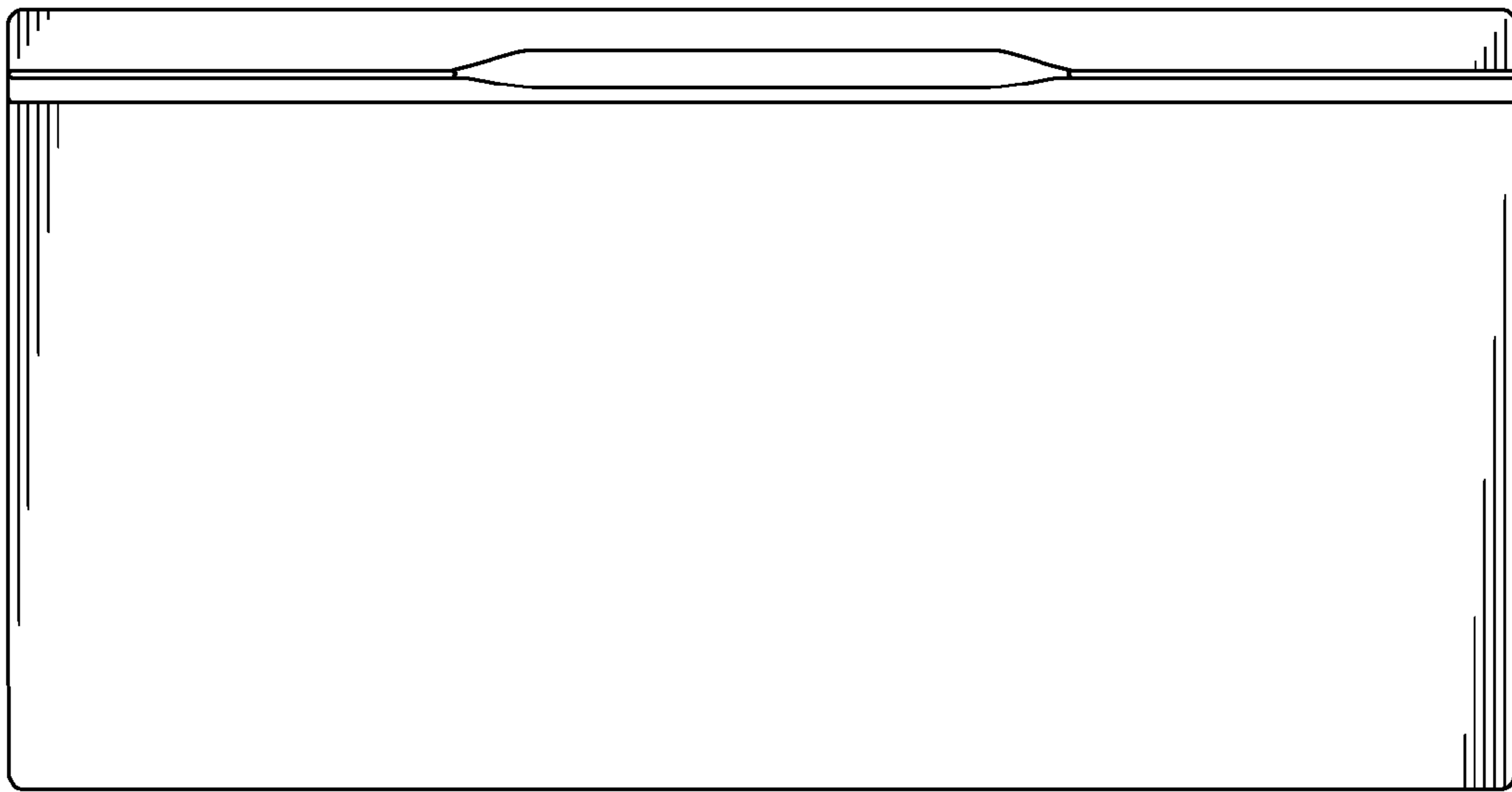

FIG. 3



FIG. 4



FIG. 5

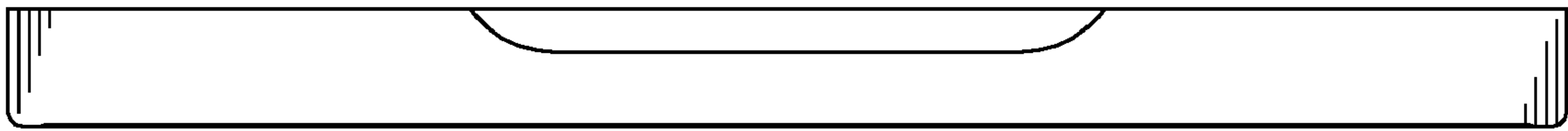

FIG. 6



FIG. 7



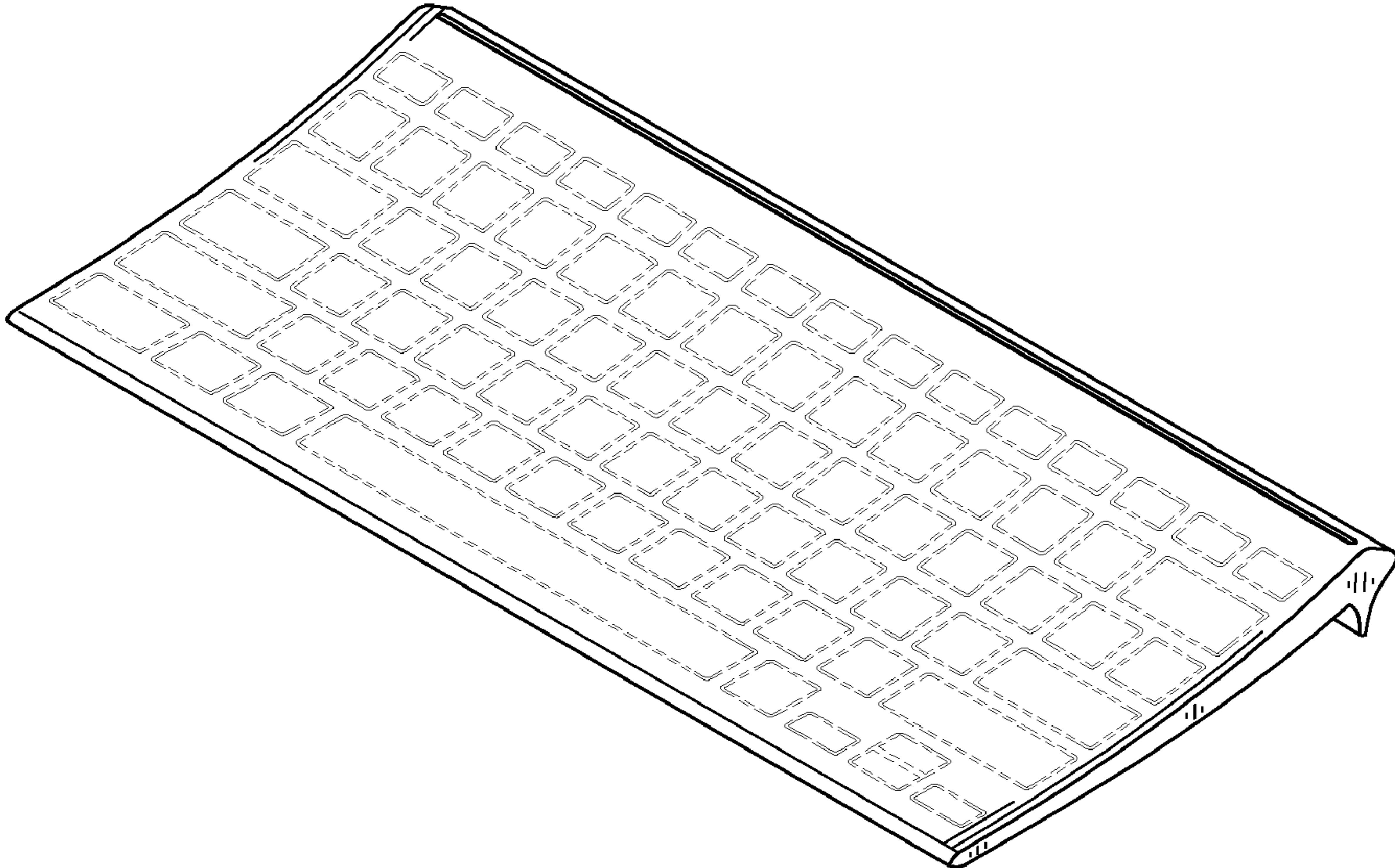

FIG. 8