

US00D628971S

(12) **United States Design Patent**
Cullin

(10) **Patent No.:** **US D628,971 S**
(45) **Date of Patent:** **** Dec. 14, 2010**

(54) **MOBILE TELEPHONE**

(75) Inventor: **Peter Cullin**, Lund (SE)

(73) Assignee: **Doro AB**, Lund (SE)

(**) Term: **14 Years**

(21) Appl. No.: **29/341,813**

(22) Filed: **Aug. 13, 2009**

(30) **Foreign Application Priority Data**

Feb. 16, 2009 (EM) 1089064

(51) **LOC (9) Cl.** **14-03**

(52) **U.S. Cl.** **D14/138 AB**

(58) **Field of Classification Search** D14/138 AB,
D14/496, 341, 345, 346, 203.3, 203.4, 203.7;
455/575.3; D21/517; 379/433.13
See application file for complete search history.

(56) **References Cited**

U.S. PATENT DOCUMENTS

D493,440	S	*	7/2004	Chou et al.	D14/138 AB
D498,468	S	*	11/2004	Seo	D14/138 AB
7,269,443	B2	*	9/2007	Park et al.	455/556.2
D561,719	S	*	2/2008	Cho et al.	D14/138 AB
D573,575	S	*	7/2008	Song et al.	D14/138 AB
D573,968	S	*	7/2008	Chen et al.	D14/138 AB
D578,498	S	*	10/2008	Choi et al.	D14/138 AB
D578,979	S	*	10/2008	Choi et al.	D14/138 AB
D583,794	S	*	12/2008	Lee et al.	D14/138 AB
D585,406	S	*	1/2009	Morrison et al.	D14/138 AB
D586,309	S	*	2/2009	Song et al.	D14/138 AB

(Continued)

OTHER PUBLICATIONS

Samsung I6210 telephone, announced Dec. 2008, [online], [site visited Aug. 10, 2010]. Available from Internet ,<URL: http://www.gsmarena.com>.*

(Continued)

Primary Examiner—Jeffrey D Asch

(74) *Attorney, Agent, or Firm*—Nixon & Vanderhye P.C.

(57) **CLAIM**

The ornamental design for a “mobile telephone,” as shown and described.

DESCRIPTION

FIG. 1 is a perspective front view of the open mobile telephone.

FIG. 2 is another perspective front view of the open mobile telephone;

FIG. 3 is a rear view of the open mobile telephone.

FIG. 4 is a left side view of the open mobile telephone.

FIG. 5 is a right side view of the closed mobile telephone.

FIG. 6 is a top view of the closed mobile telephone.

FIG. 7 is a bottom view of the closed mobile telephone.

FIG. 8 is a front view of the closed mobile telephone.

FIG. 9 is a rear view of the closed mobile telephone.

FIG. 10 is a left side view of the closed mobile telephone.

FIG. 11 is a right side view of the open mobile telephone; and,

FIG. 12 is a bottom view of the open mobile telephone.

The broken lines shown throughout the views are superimposed on continuous claimed surfaces, are directed to environment, and are for illustrative purposes only; the broken lines form no part of the first and second embodiments.

1 Claim, 11 Drawing Sheets

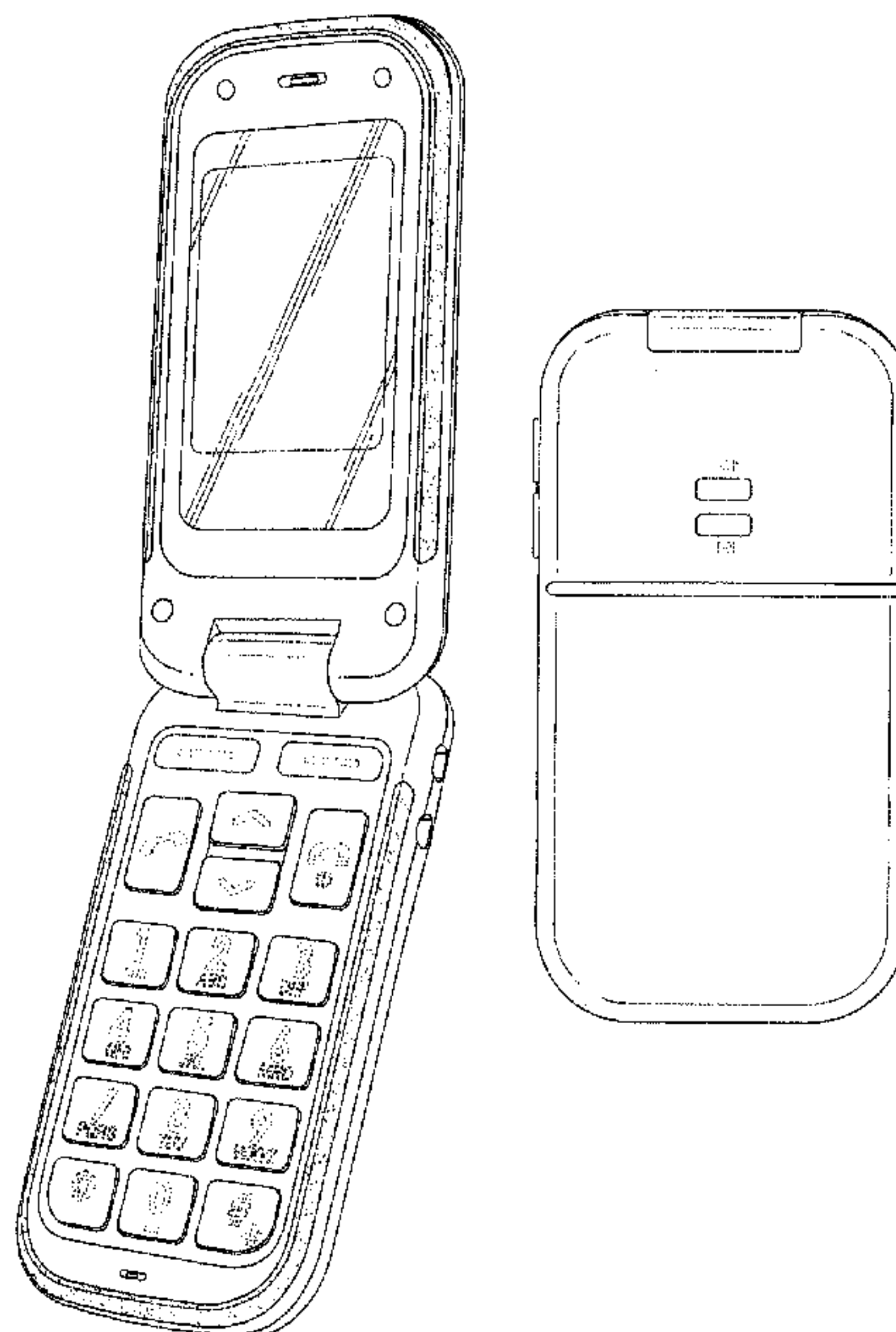

U.S. PATENT DOCUMENTS

D593,981	S *	6/2009	Boucquey et al.	D14/138 AB
D593,986	S *	6/2009	Chen et al.	D14/138 AB
D597,996	S *	8/2009	Kang	D14/138 AB
D597,997	S *	8/2009	Song et al.	D14/138 AB
D599,767	S *	9/2009	Lee et al.	D14/138 AB
D601,986	S *	10/2009	Hong et al.	D14/138 AB
7,599,720	B2 *	10/2009	Fujihara et al.	455/575.1
D604,259	S *	11/2009	Kim	D14/138 AB
D604,262	S *	11/2009	Lee	D14/138 AB
D607,857	S *	1/2010	Kim et al.	D14/138 AB
D616,846	S *	6/2010	Byun et al.	D14/138 AB
2006/0019728	A1 *	1/2006	Sakamoto et al.	455/575.3
2007/0167197	A1 *	7/2007	Fuke et al.	455/575.1
2009/0149227	A1 *	6/2009	Yamaguchi	455/575.3
2010/0041449	A1 *	2/2010	Nakao et al.	455/575.3

OTHER PUBLICATIONS

BenQ-Siemens A53 telephone, announced Apr. 2007, [online], [site visited Aug. 10, 2010]. Available from Internet ,<URL: <http://www.gsmarena.com>>.*

LG KF350 telephone, announced Aug. 2008, [online], [site visited Aug. 10, 2010]. Available from Internet ,<URL: <http://www.gsmarena.com>>.*

Sharp GX33 telephone, announced 3rd quarter 2007, [online], [site visited Aug. 10, 2010]. Available from Internet ,<URL: <http://www.gsmarena.com>>.*

Sharp 903 telephone, announced Jul. 2005, [online], [site visited Aug. 10, 2010]. Available from Internet ,<URL: <http://www.gsmarena.com>>.*

Haier A66 telephone, announced 2010, [online], [site visited Aug. 10, 2010]. Available from Internet ,<URL: <http://www.gsmarena.com>>.*

Sony Ericsson R306 Radio telephone, announced Jan. 2008, [online], [site visited Aug. 10, 2010]. Available from Internet ,<URL: <http://www.gsmarena.com>>.*

* cited by examiner

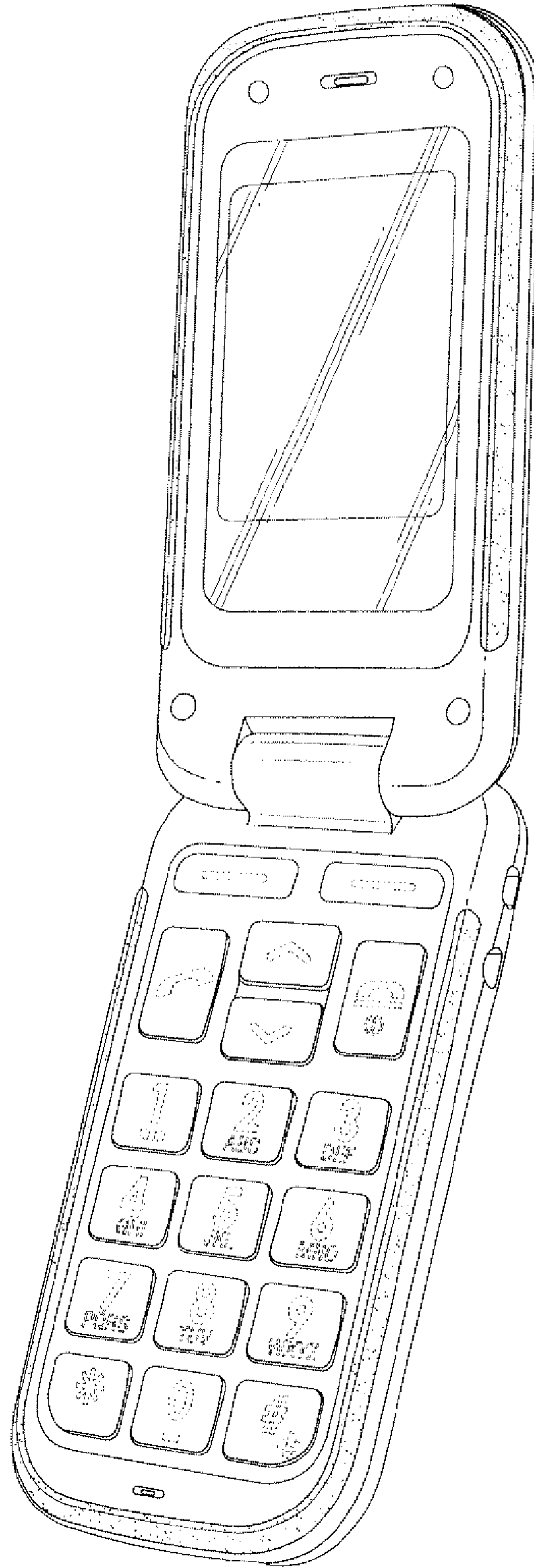

Figure 1

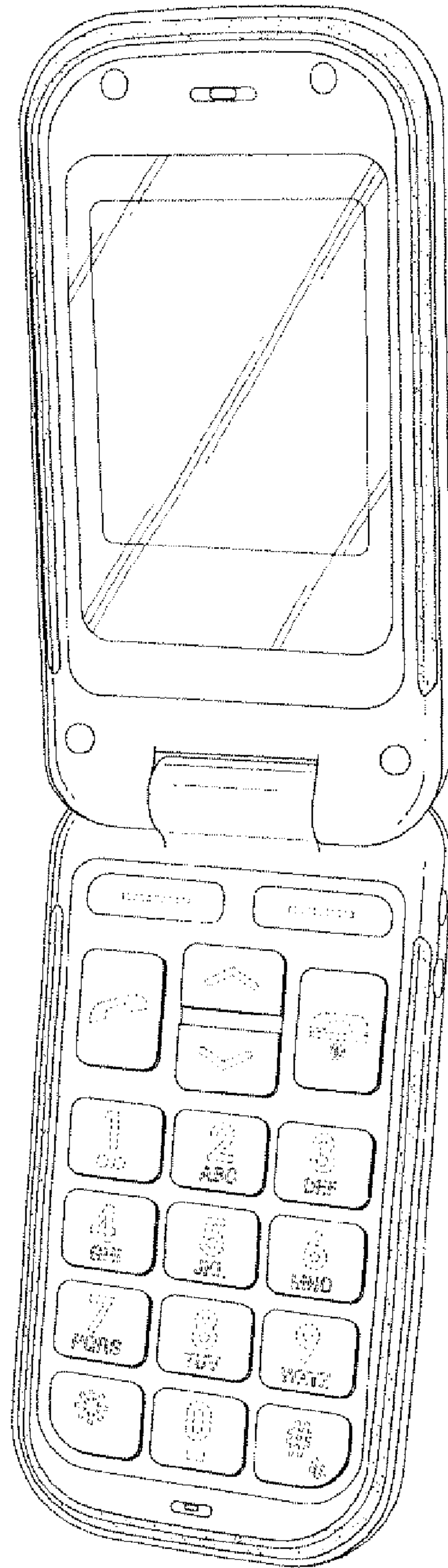

Figure 2

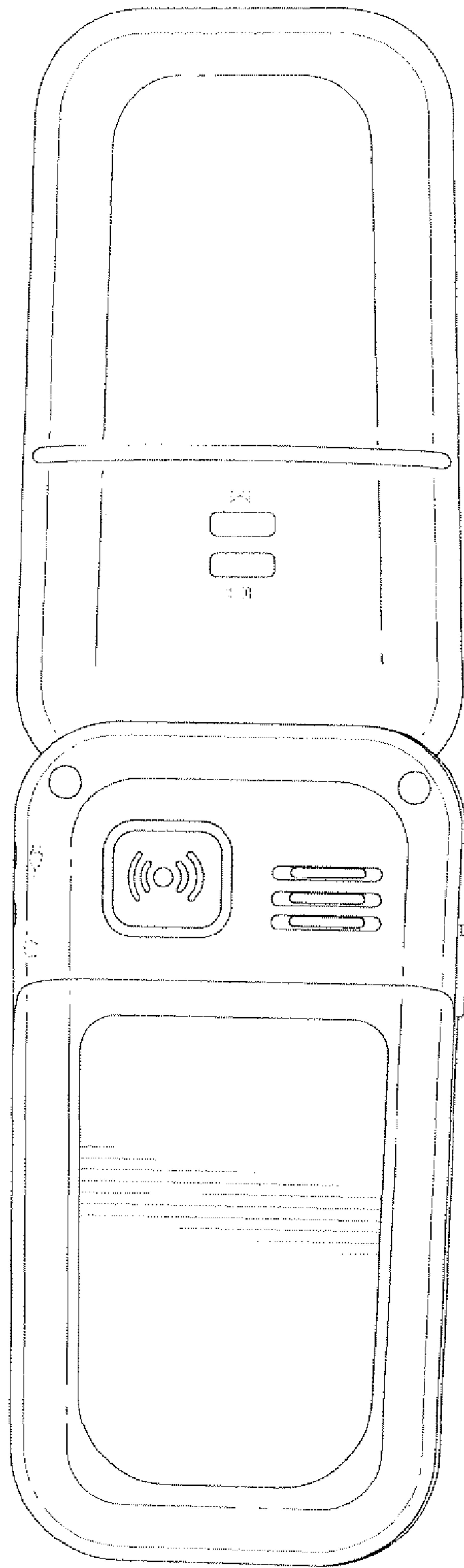

Figure 3

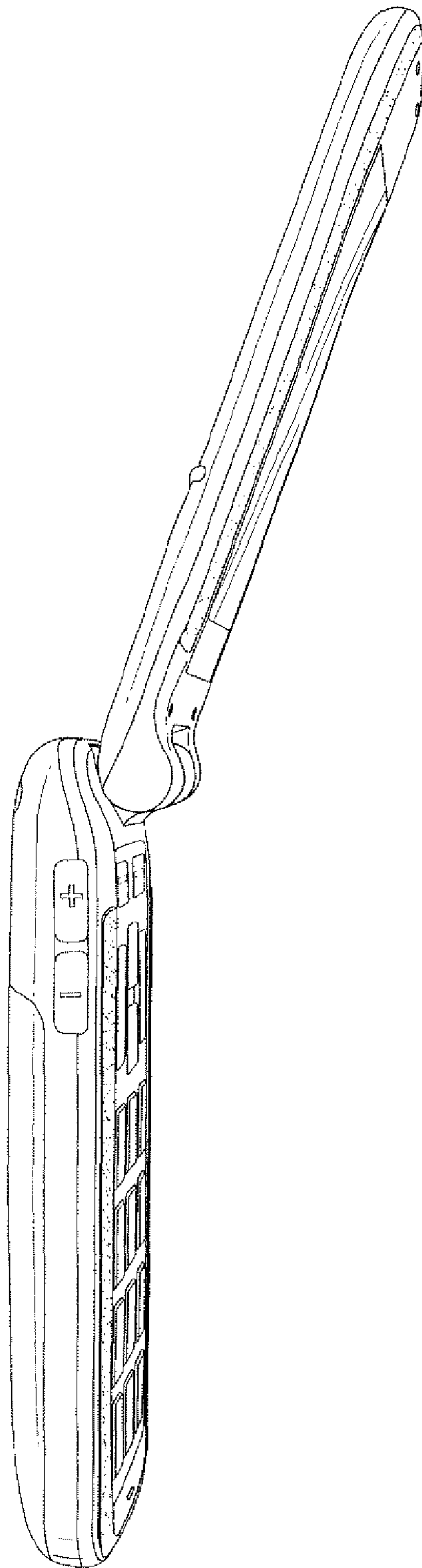

Figure 4

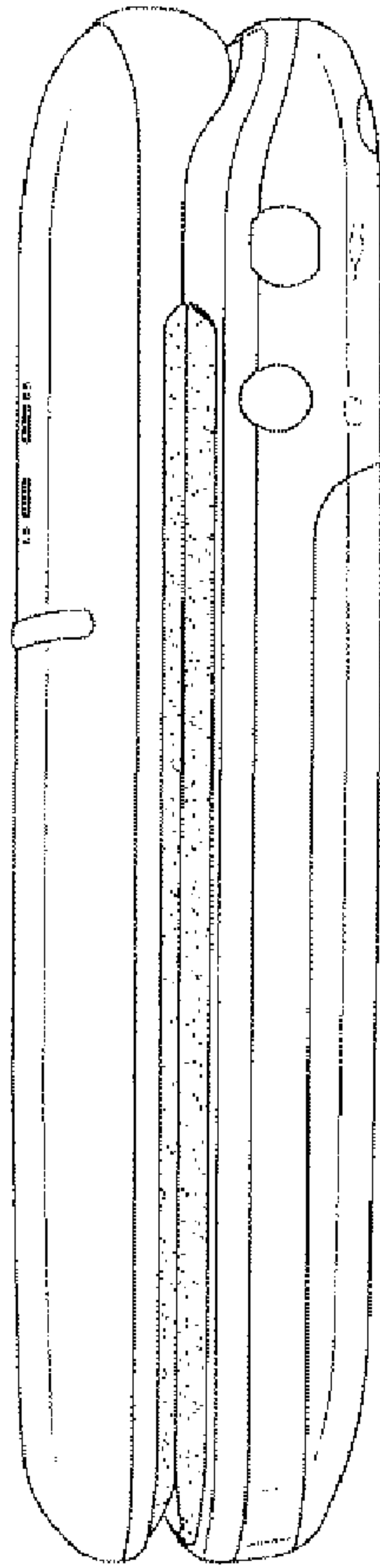

Figure 5

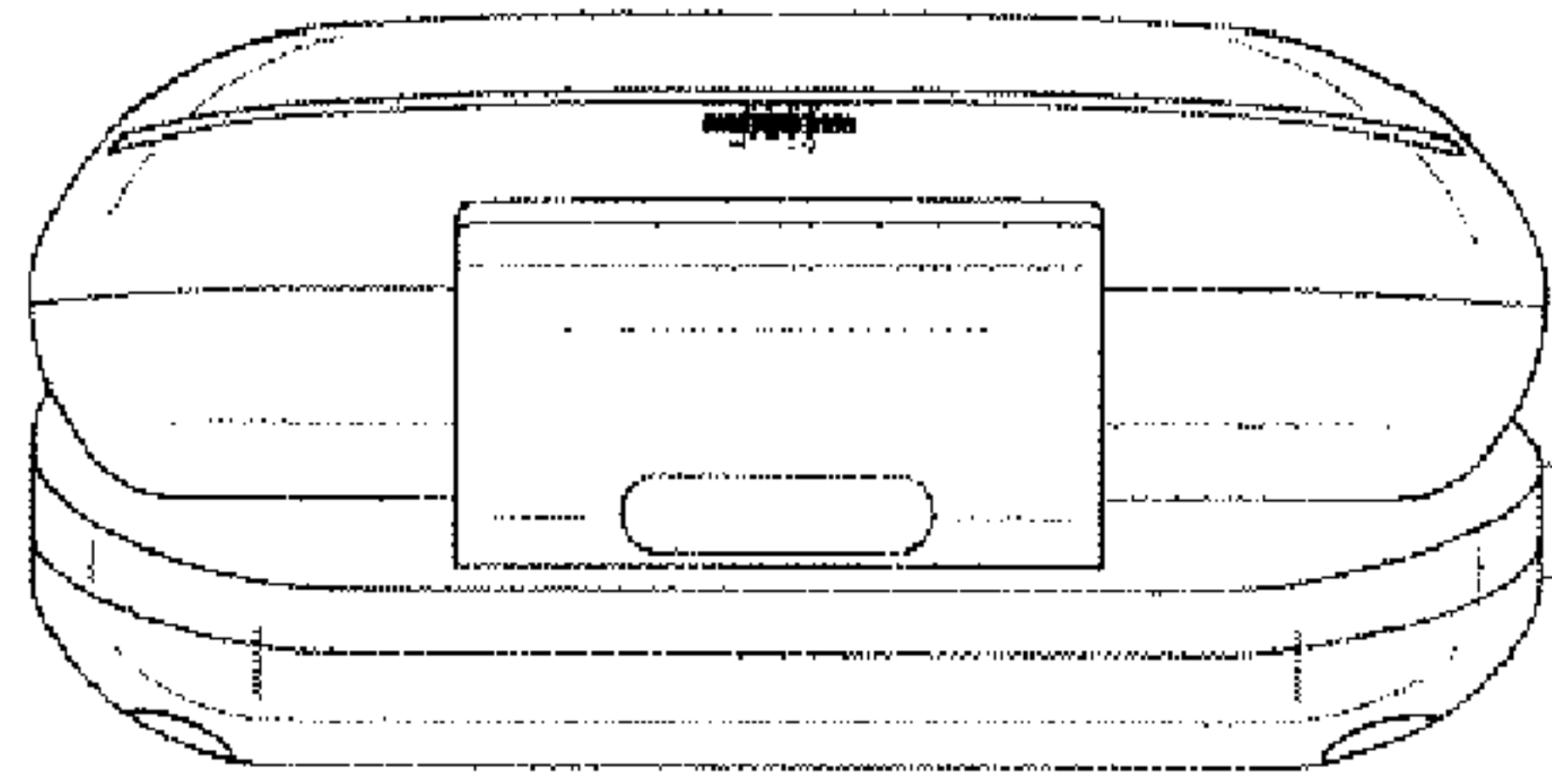

Figure 6

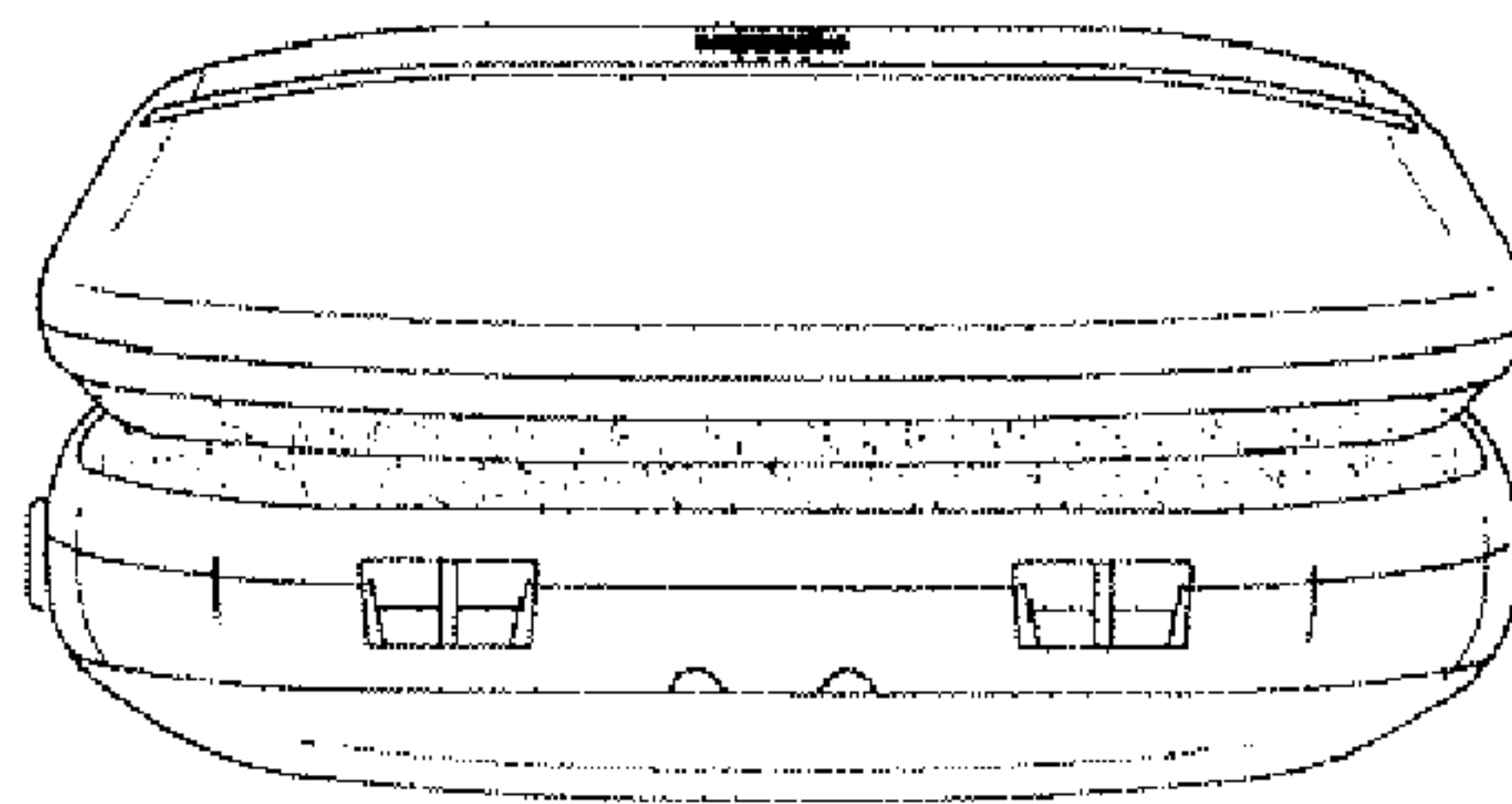

Figure 7

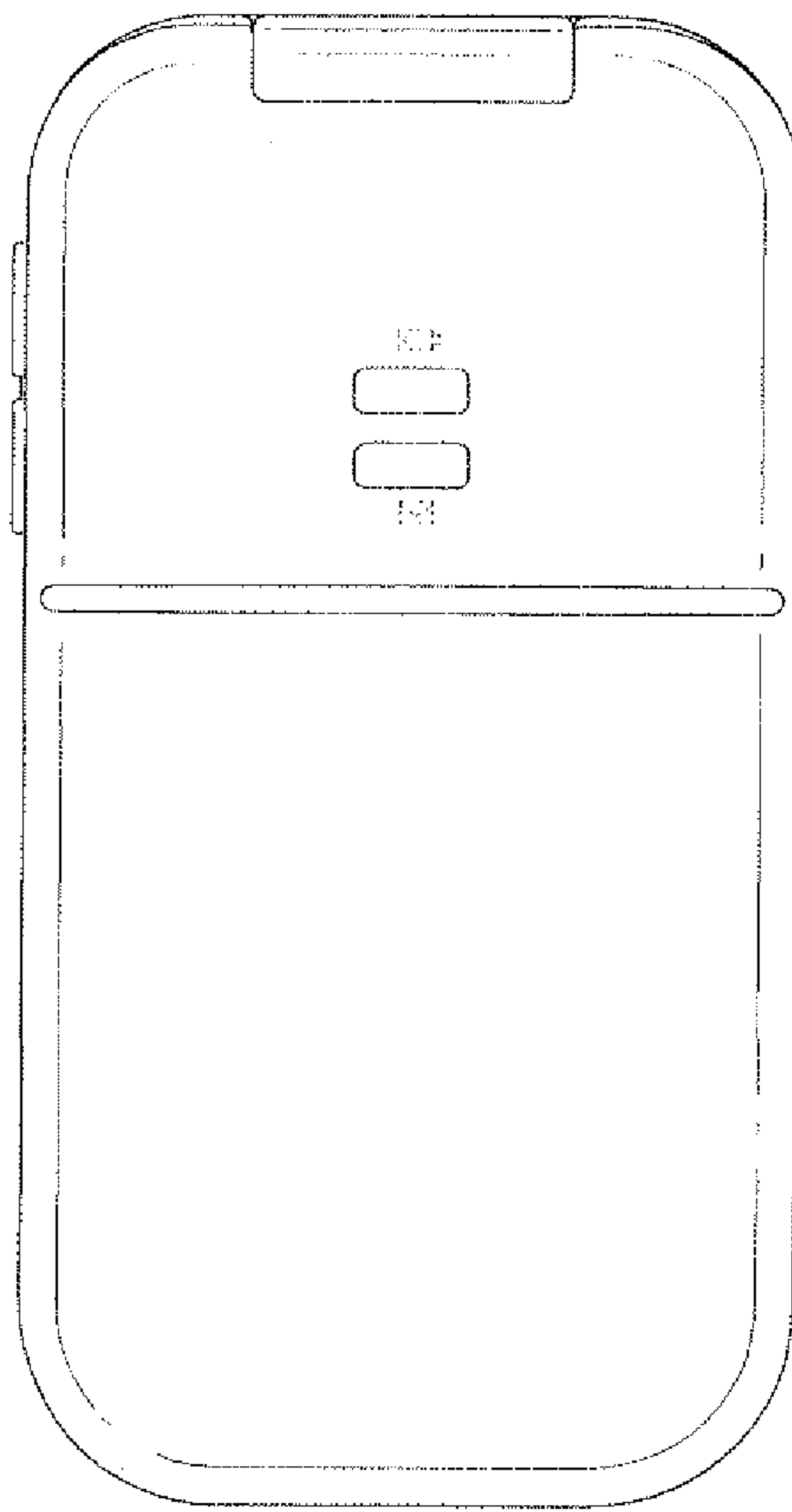

Figure 8

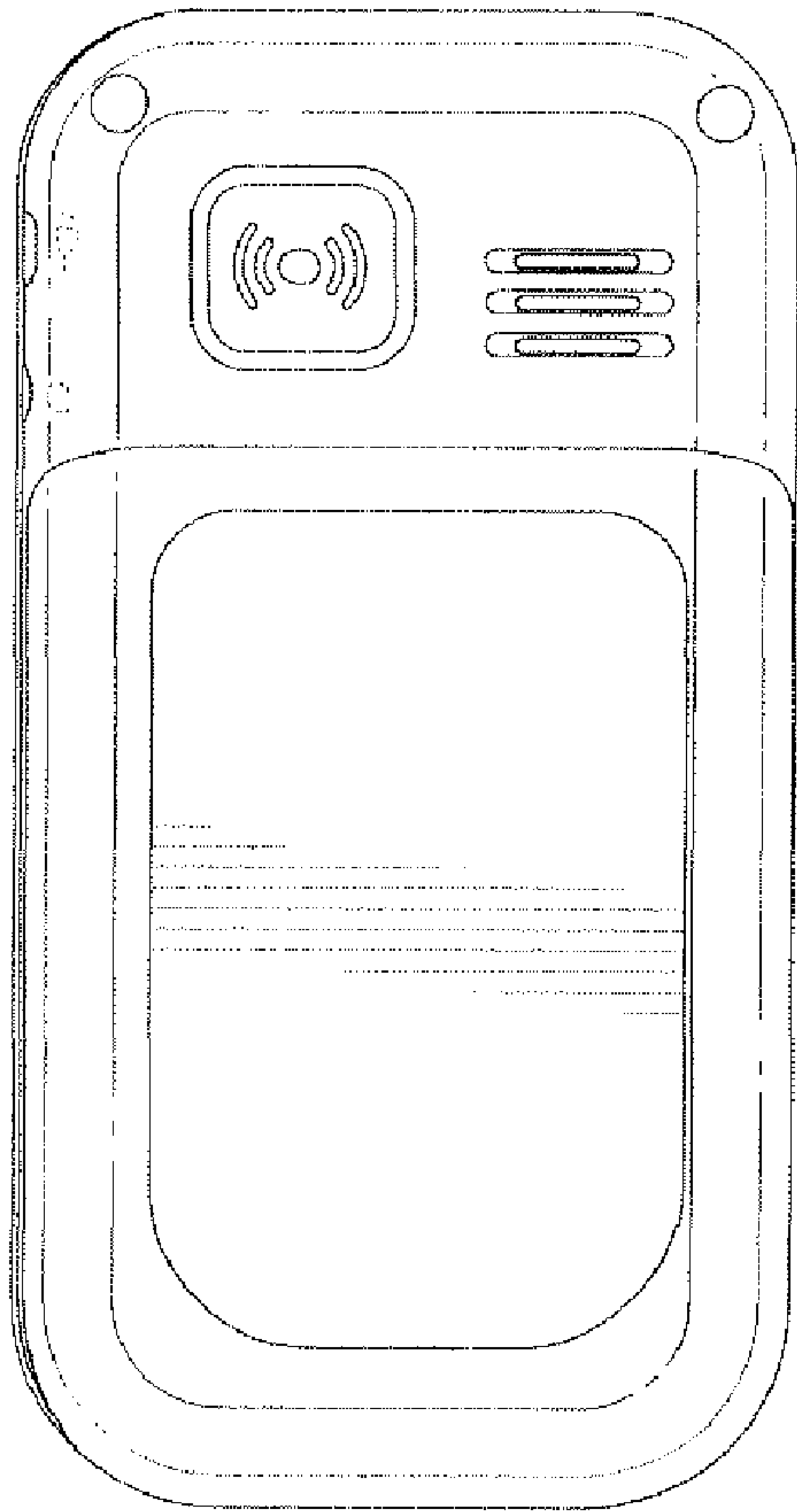

Figure 9

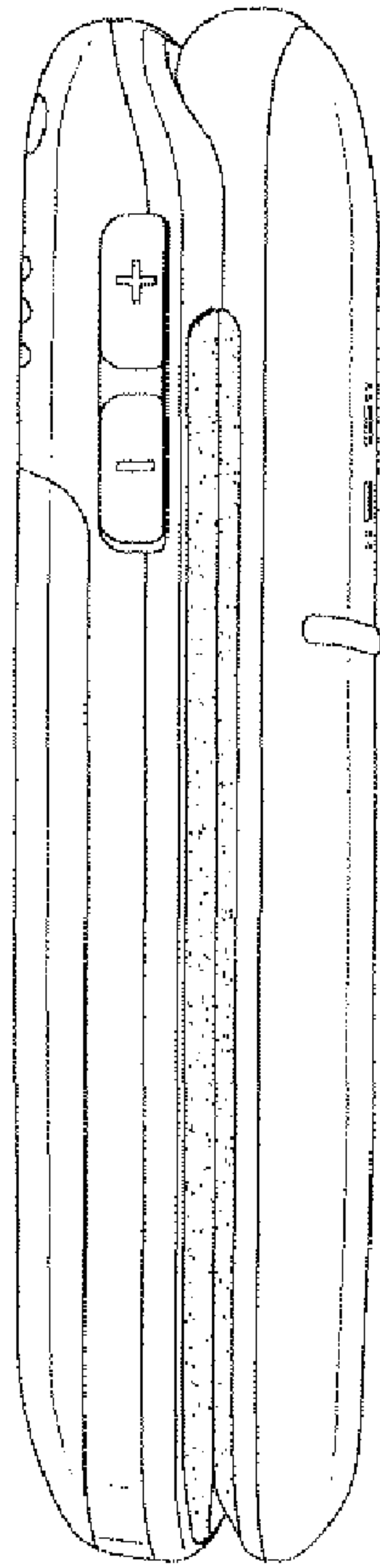

Figure 10

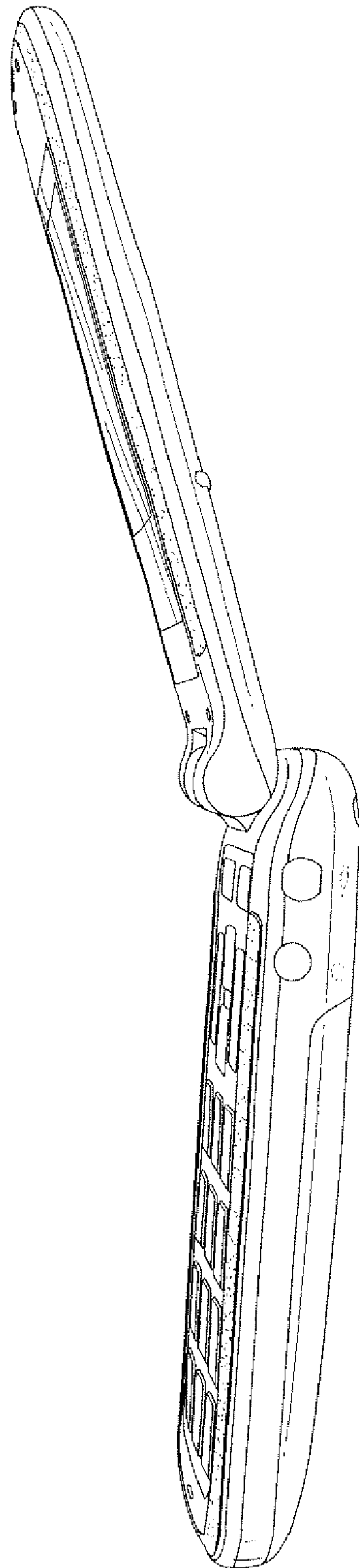

Figure 11

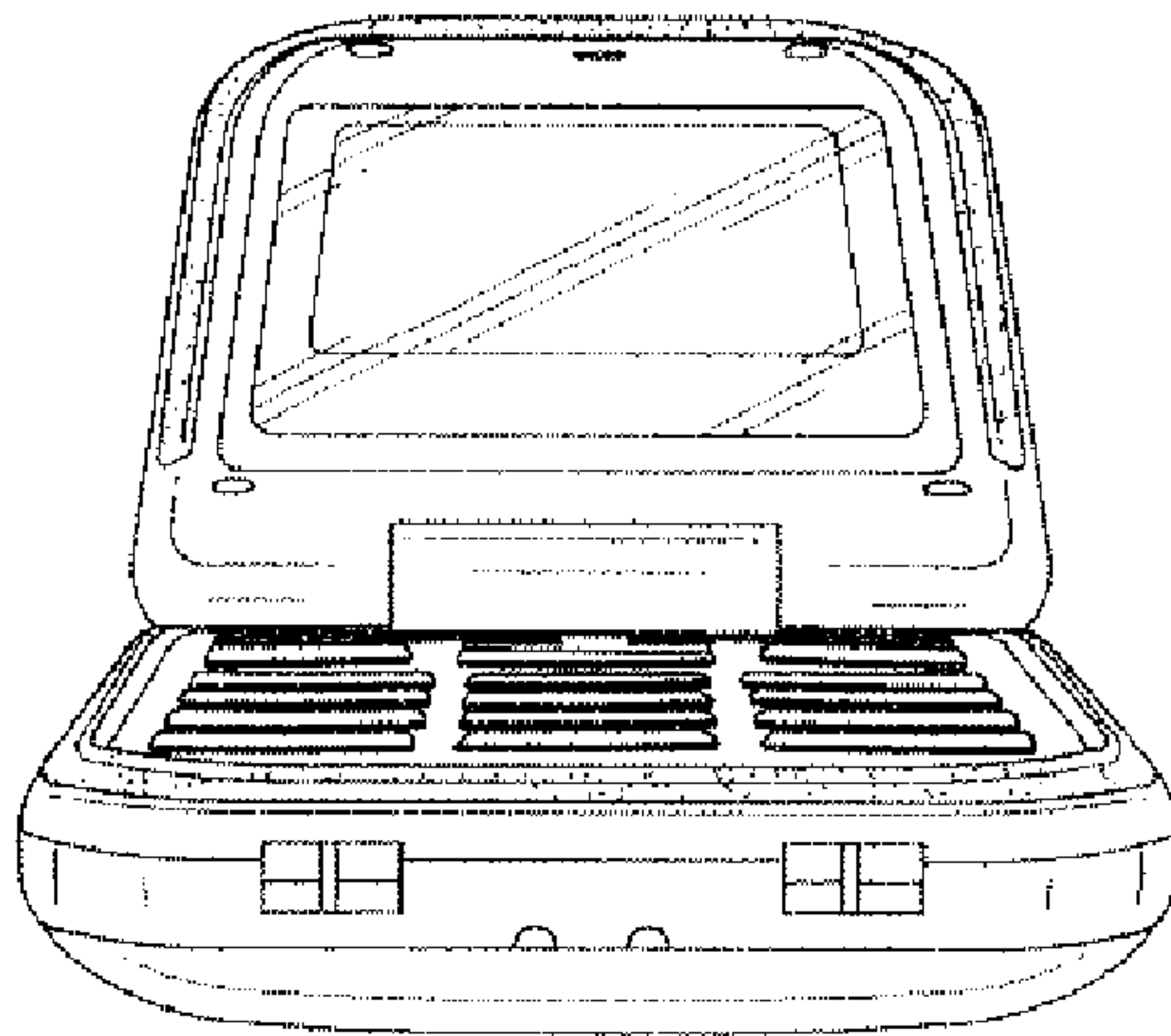

Figure 12