



US00D628694S

(12) **United States Design Patent**
Donnez

(10) **Patent No.:** **US D628,694 S**
(45) **Date of Patent:** **** Dec. 7, 2010**

(54) **MEDICAL DEVICE**

(75) Inventor: **Jacques Donnez**, Brussels (BE)

(73) Assignee: **Karl Storz GmbH & Co. KG**,
Tuttlingen (DE)

(**) Term: **14 Years**

(21) Appl. No.: **29/350,529**

(22) Filed: **Nov. 18, 2009**

(30) **Foreign Application Priority Data**

May 18, 2009 (EM) 001516550-0013

(51) **LOC (9) Cl.** **24-02**

(52) **U.S. Cl.** **D24/141; D24/133; D24/147**

(58) **Field of Classification Search** D24/107–108,
D24/133, 135, 141, 146, 147, 140, 144–145;
600/227, 229, 232, 233, 235, 591, 587; 604/181,
604/187; 606/1, 8, 108, 119, 135, 193–194,
606/167, 205

See application file for complete search history.

(56) **References Cited**

U.S. PATENT DOCUMENTS

4,430,076	A *	2/1984	Harris	606/119
4,628,941	A *	12/1986	Kosasky	600/572
5,394,863	A *	3/1995	Sanford et al.	606/119
5,464,409	A *	11/1995	Mohajer	606/119
5,571,115	A *	11/1996	Nicholas	606/119
6,200,306	B1 *	3/2001	Klostermeyer et al.	606/1
6,423,075	B1 *	7/2002	Singh et al.	606/119
D536,446	S *	2/2007	Doll et al.	D24/133

2001/0021854	A1 *	9/2001	Donnez et al.	606/119
2005/0277948	A1 *	12/2005	Cedars et al.	606/119
2009/0048609	A1 *	2/2009	Atiomo et al.	606/119
2009/0131954	A1 *	5/2009	Christian et al.	606/119

* cited by examiner

Primary Examiner—Ian Simmons

Assistant Examiner—Wan Laymon

(74) *Attorney, Agent, or Firm*—Muncy, Geissler, Olds & Lowe, PLLC

(57) **CLAIM**

The ornamental design for a medical device, as shown and described.

DESCRIPTION

FIG. 1 is a left side perspective view of a medical device according to an embodiment of the present invention.

FIG. 2 is a right side perspective view of the medical device of FIG. 1.

FIG. 3 is a front perspective view of the medical device of FIG. 1.

FIG. 4 is a rear perspective view of the medical device of FIG. 1.

FIG. 5 is an enlarged top perspective view of the medical device of FIG. 1.

FIG. 6 is an enlarged bottom perspective view of the medical device of FIG. 1; and,

FIG. 7 is another perspective view of the medical device of FIG. 1.

1 Claim, 7 Drawing Sheets

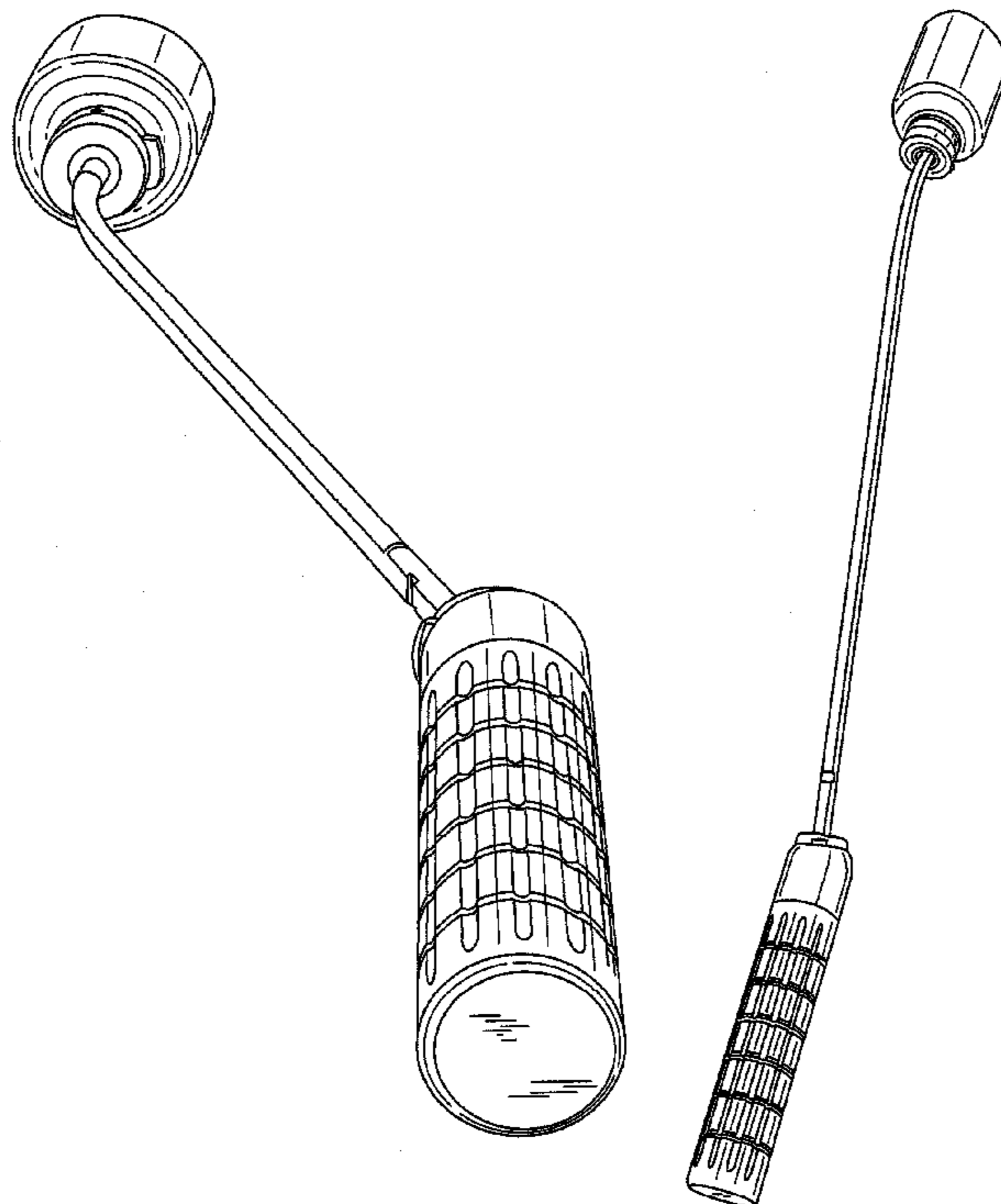

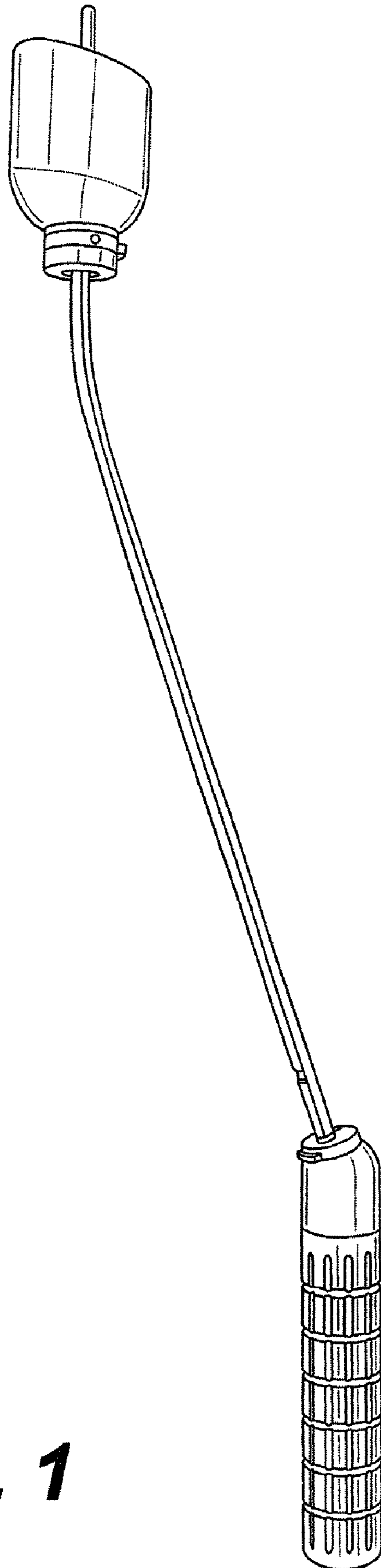

FIG. 1

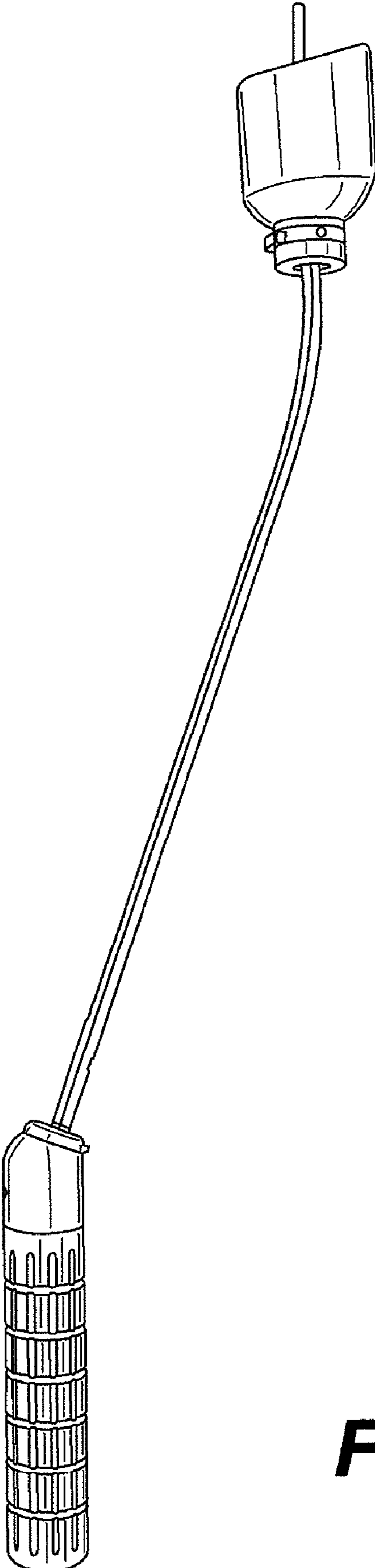

FIG. 2

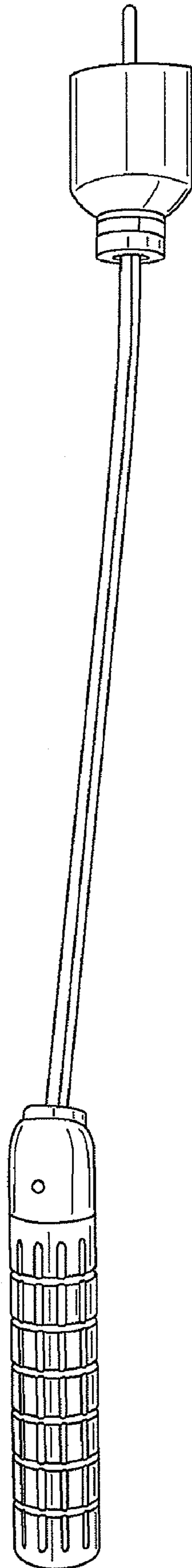

FIG. 3

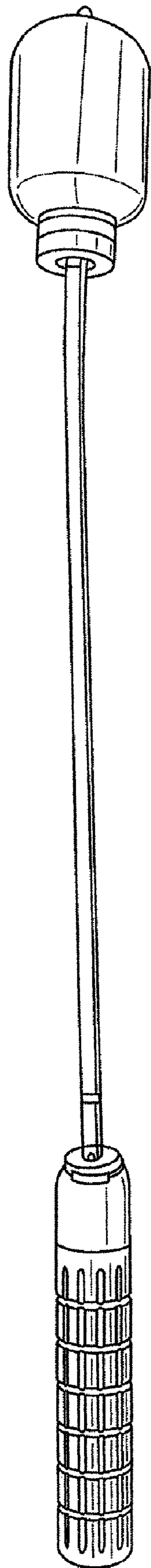

FIG. 4

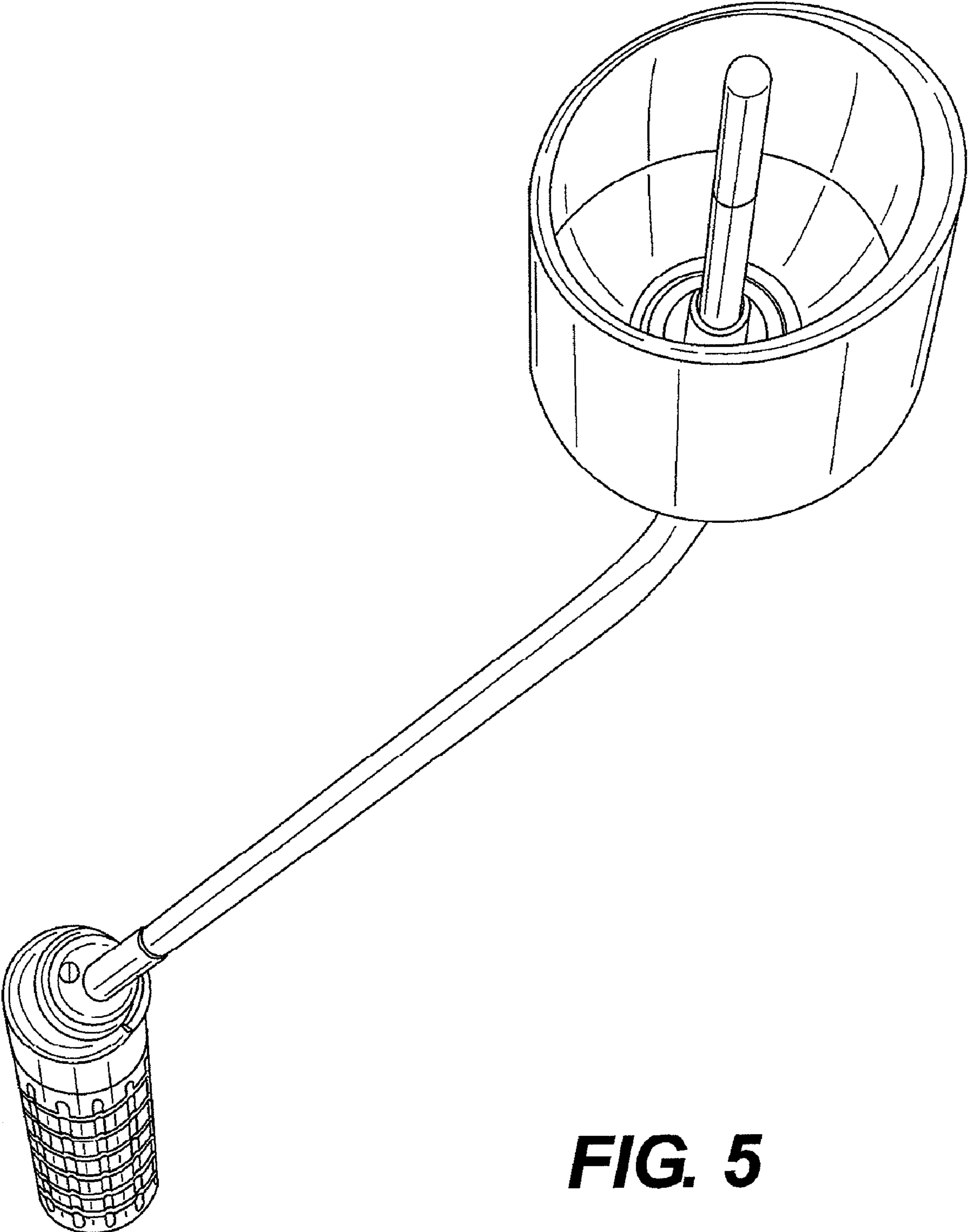

FIG. 5

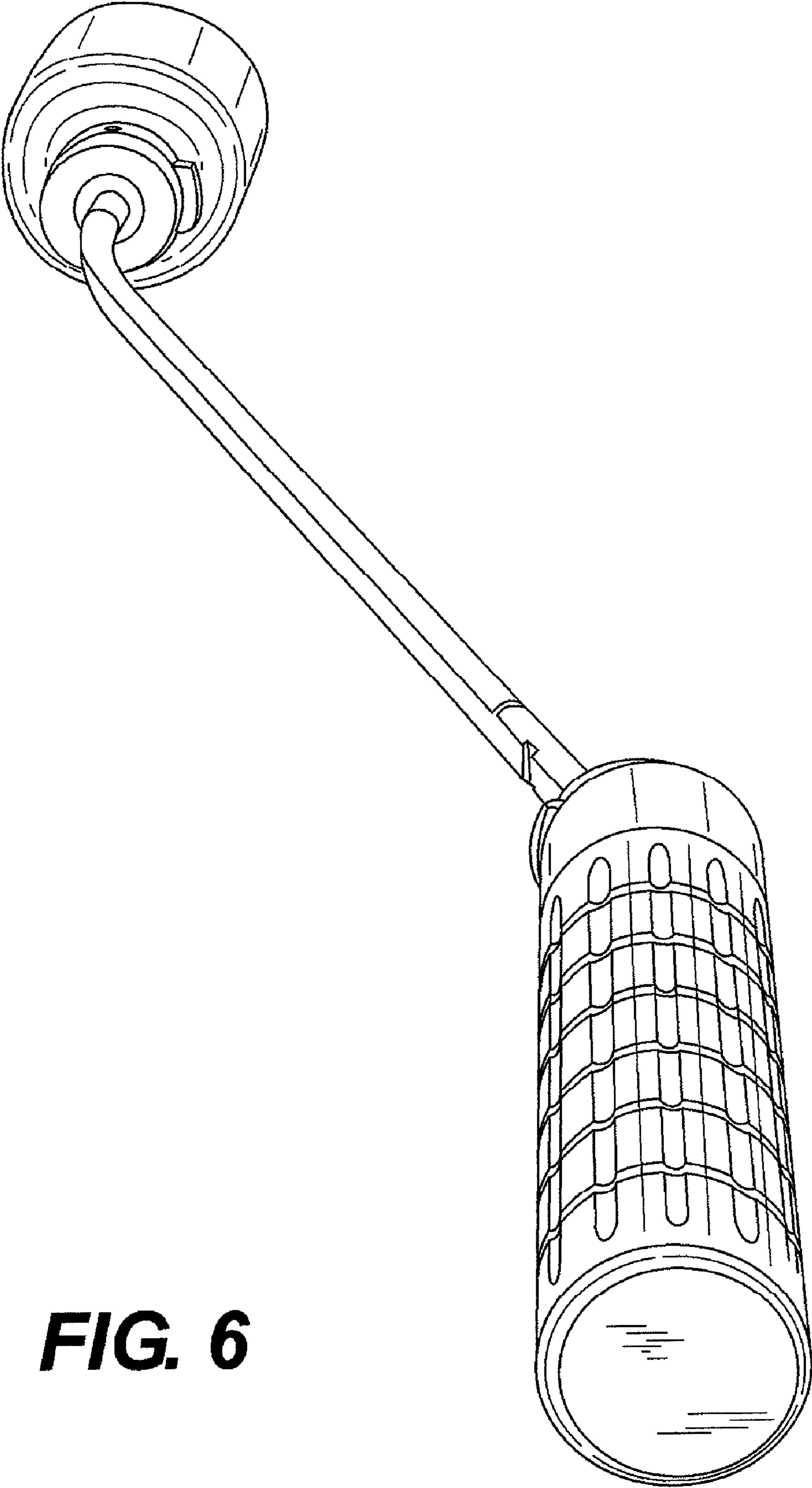

FIG. 6

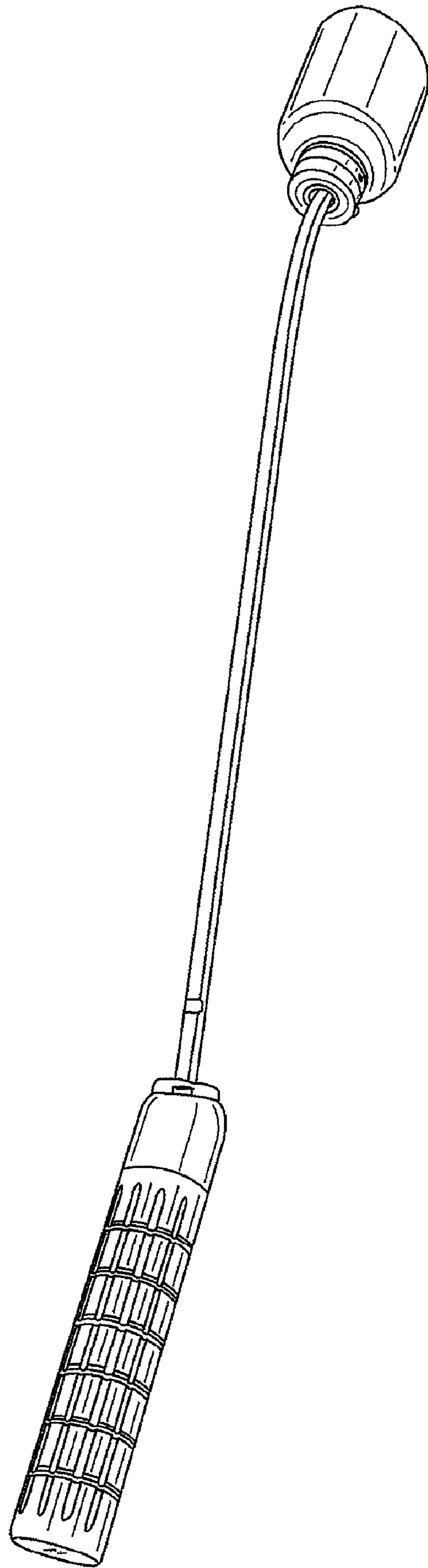

FIG. 7