



US00D628633S

(12) **United States Design Patent**  
**Zhang**

(10) **Patent No.:** **US D628,633 S**  
(45) **Date of Patent:** **\*\* Dec. 7, 2010**

(54) **PEN**  
(75) Inventor: **Biwei Zhang**, Ningbo (CN)  
(73) Assignee: **Beifa Group Co., Ltd.**, Ningbo (CN)  
(\*\*) Term: **14 Years**  
(21) Appl. No.: **29/354,385**  
(22) Filed: **Jan. 22, 2010**

(30) **Foreign Application Priority Data**  
Jul. 23, 2009 (CN) ..... 2009 3 0203712

(51) **LOC (9) Cl.** ..... **19-06**  
(52) **U.S. Cl.** ..... **D19/46**  
(58) **Field of Classification Search** ..... D14/411,  
D14/431; D19/35, 36, 41, 42, 43, 44, 45,  
D19/46, 47, 48, 49, 50, 51, 54, 55, 56; 24/11 F,  
24/11 P, 11 R; 401/6, 52, 99, 100, 104, 105,  
401/106, 107, 108, 109, 192, 195, 243, 244,  
401/245, 246, 247  
See application file for complete search history.

(56) **References Cited**  
**U.S. PATENT DOCUMENTS**  
D56,680 S 11/1920 Sawyer  
1,750,032 A \* 3/1930 Timtiman ..... 257/41  
D160,180 S \* 9/1950 Kovacs ..... D19/49  
3,317,036 A \* 5/1967 Cherba ..... 401/78  
D223,307 S \* 4/1972 Nockolds ..... D19/51  
D258,217 S 2/1981 Sakaoka  
D265,740 S \* 8/1982 Pook ..... D19/36  
D289,425 S \* 4/1987 Thevenot ..... D19/49  
D294,600 S \* 3/1988 Funahashi et al. .... D19/51  
D308,075 S \* 5/1990 Yazaki ..... D19/43  
D319,662 S \* 9/1991 Henry ..... D19/43  
D326,868 S 6/1992 Nitta  
D327,621 S \* 7/1992 Heller ..... D8/82  
D329,460 S \* 9/1992 Rousseau ..... D19/46  
D358,167 S \* 5/1995 Herbst et al. .... D19/48  
D403,703 S 1/1999 Campbell  
D409,659 S \* 5/1999 Hasegawa ..... D19/51

D420,046 S \* 2/2000 Meyer et al. .... D19/47  
D427,238 S \* 6/2000 Beneyto ..... D19/43  
D436,624 S \* 1/2001 Zier ..... D19/48  
D440,601 S \* 4/2001 Sasaki ..... D19/43  
D467,970 S 12/2002 Pellissa Beneyto  
D472,923 S \* 4/2003 Wang ..... D19/48  
D545,366 S 6/2007 Ternovits  
D547,375 S 7/2007 Gerules

(Continued)

**OTHER PUBLICATIONS**

Li, B., "Pen," U.S. Appl. No. 29/357,152, filed Mar. 8, 2010.  
*Primary Examiner*—Elizabeth A Albert  
*Assistant Examiner*—Karen E Eldridge Powers  
(74) *Attorney, Agent, or Firm*—Christensen O'Connor  
Johnson Kindness PLLC

(57) **CLAIM**

The ornamental design for a pen, as shown and described.

**DESCRIPTION**

FIG. 1 is an upper front right perspective view of a pen showing my new design;  
FIG. 2 is a right side elevation view thereof, with the left side elevation view being a mirror image of the right side elevation view;  
FIG. 3 is a front elevation view thereof;  
FIG. 4 is a rear elevation view thereof;  
FIG. 5 is an enlarged top plan view thereof; and,  
FIG. 6 is an enlarged bottom plan view thereof.

**1 Claim, 3 Drawing Sheets**

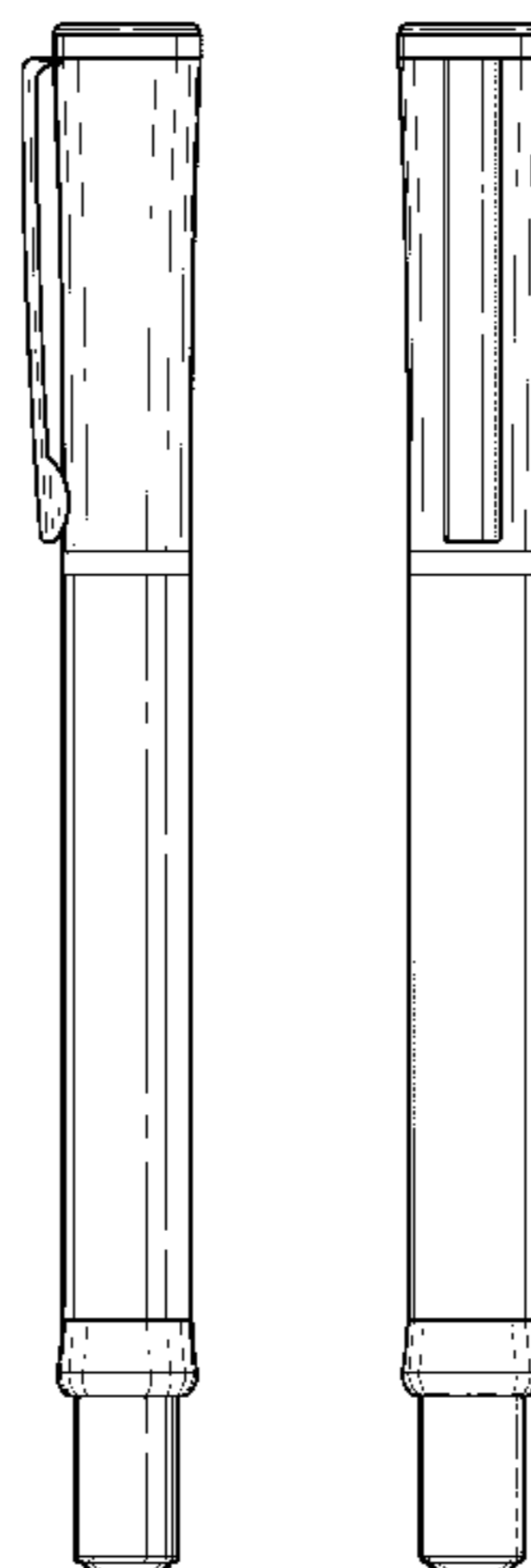

# US D628,633 S

Page 2

---

## U.S. PATENT DOCUMENTS

D556,825 S * 12/2007 Bruzzi .....	D19/51	D580,975 S * 11/2008 Yu et al. ....	D19/45
D561,832 S * 2/2008 Bhavnani .....	D19/51	D589,555 S * 3/2009 Li .....	D19/36
D568,932 S 5/2008 Qiu		D601,627 S 10/2009 Liu	
D568,939 S * 5/2008 Bhavnani .....	D19/57	D607,934 S 1/2010 Liu	
		D611,098 S * 3/2010 Collin .....	D19/49

\* cited by examiner

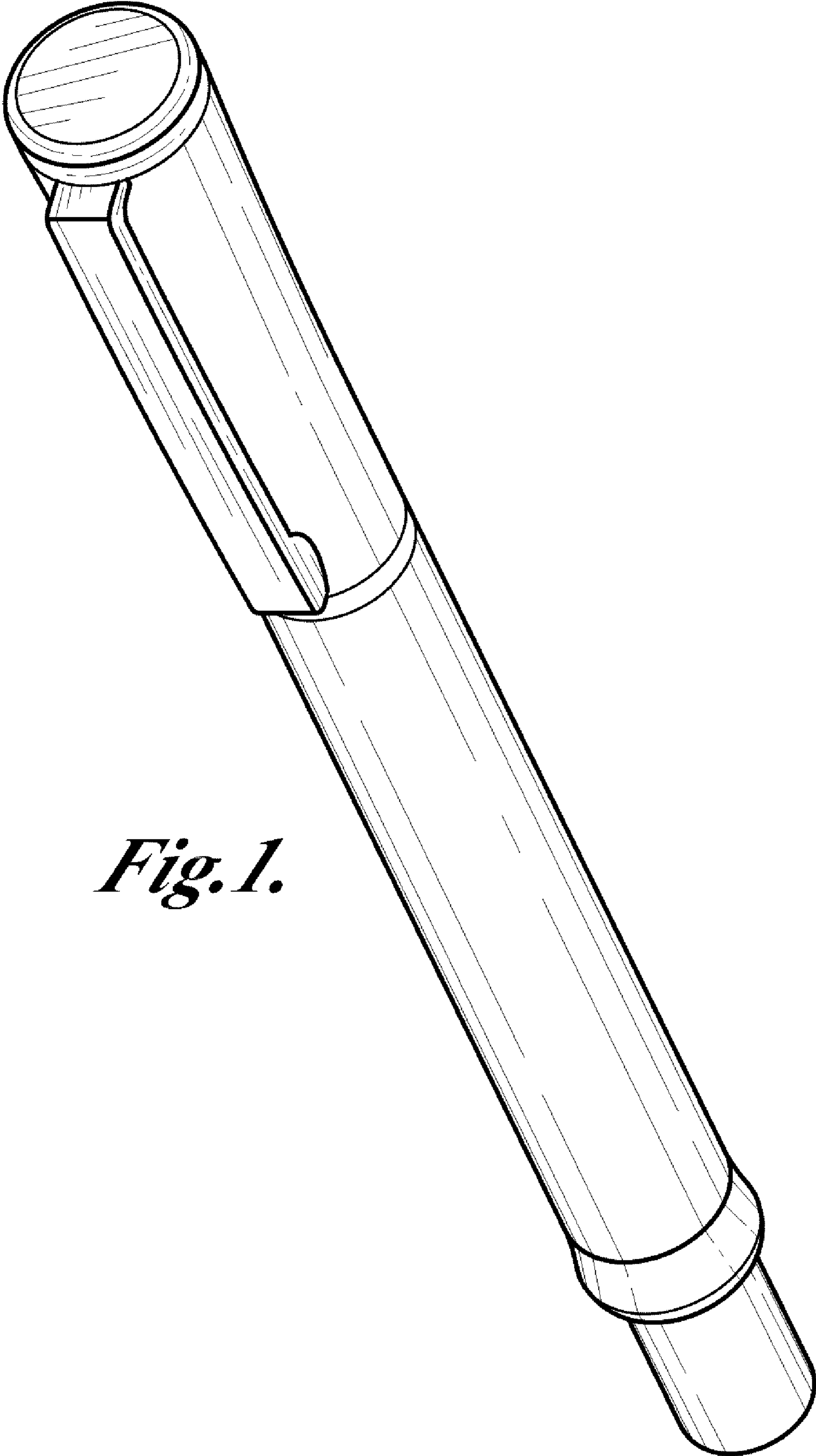

*Fig. 1.*

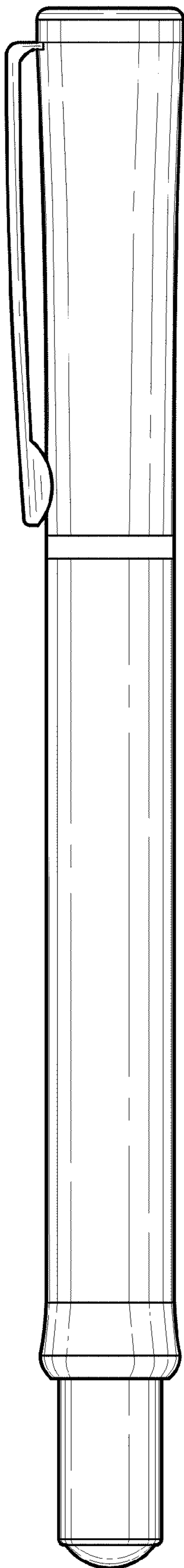

*Fig. 2.*

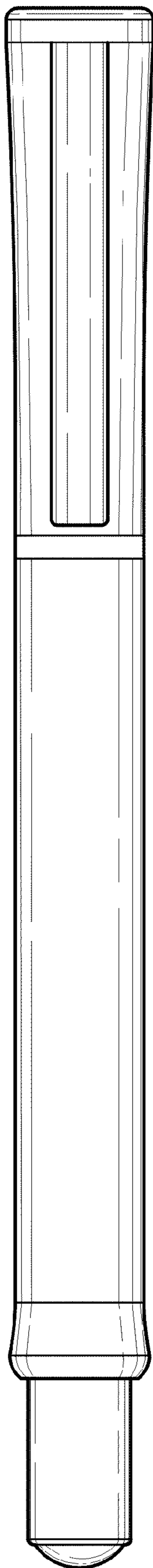

*Fig. 3.*

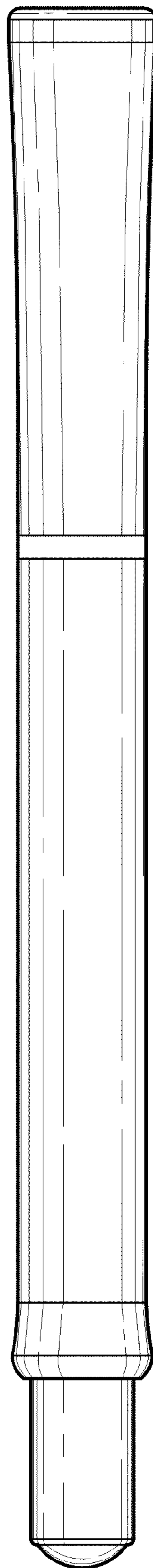

*Fig. 4.*

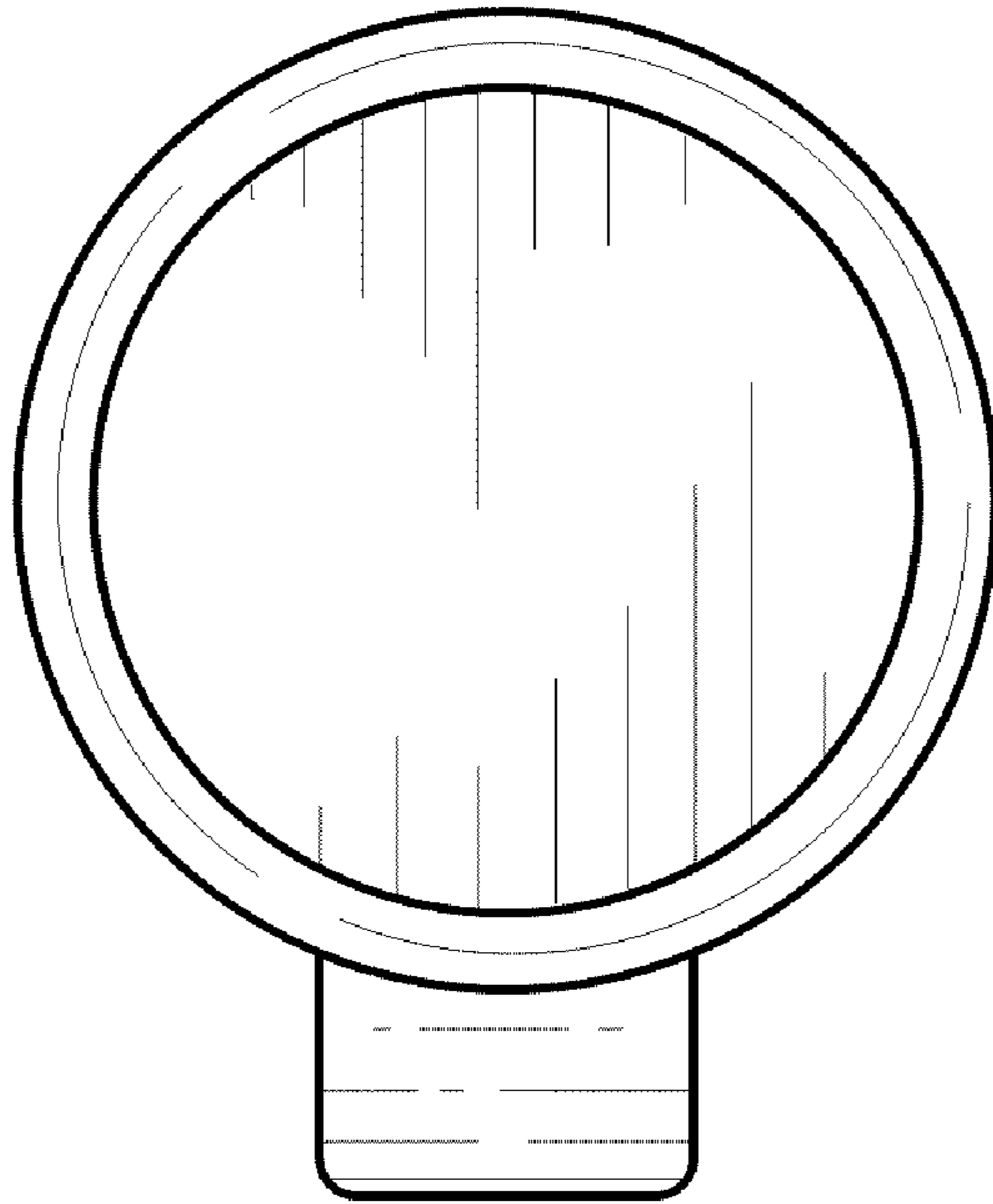

*Fig. 5.*

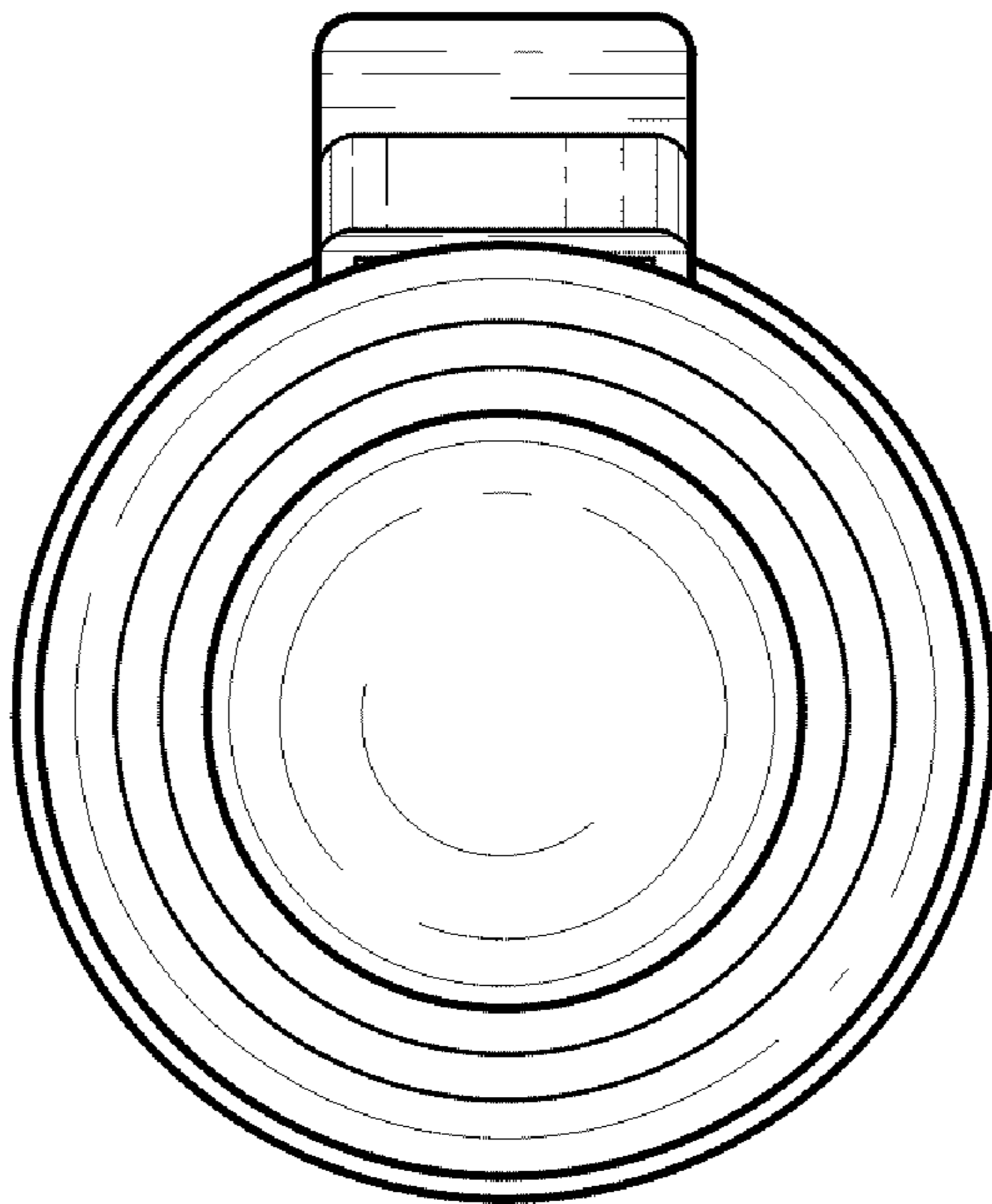

*Fig. 6.*