



US00D628632S

(12) **United States Design Patent**
Liu

(10) **Patent No.:** **US D628,632 S**
(45) **Date of Patent:** **** Dec. 7, 2010**

(54) **MARKER**

(75) Inventor: **Luosen Liu**, Ningbo (CN)

(73) Assignee: **Beifa Group Co., Ltd.**, Ningbo (CN)

(**) Term: **14 Years**

(21) Appl. No.: **29/352,719**

(22) Filed: **Dec. 23, 2009**

(30) **Foreign Application Priority Data**

Jun. 24, 2009 (CN) 2009 3 0181742

(51) **LOC (9) Cl.** **19-06**

(52) **U.S. Cl.** **D19/44**

(58) **Field of Classification Search** D19/35,
D19/36, 41, 42, 43, 44, 45, 46, 47, 48, 49,
D19/50, 51, 54, 55, 56; 24/11 F, 11 P, 11 R;
401/6, 52, 99, 100, 104, 105, 106, 107, 108,
401/109, 192, 195, 243, 244, 245, 246, 247

See application file for complete search history.

(56) **References Cited**

U.S. PATENT DOCUMENTS

- 903,431 A * 11/1908 Arnold 30/113
- 1,427,985 A * 9/1922 Vasselli 401/85
- 1,506,207 A * 8/1924 Wahl 24/10 R
- D80,362 S 1/1930 Cuthbert
- 1,868,200 A * 7/1932 Freedman 401/98
- 2,075,033 A * 3/1937 Garner 446/100
- D151,307 S * 10/1948 Weston D19/57
- 3,159,863 A * 12/1964 La Mura 401/101
- 4,517,628 A * 5/1985 McDermott 362/186
- D344,541 S 2/1994 Guo
- D359,510 S * 6/1995 Chuang D19/57
- D449,857 S 10/2001 Rosenbaum
- D465,805 S 11/2002 Hu
- D474,239 S 5/2003 Rosenbaum
- D475,088 S 5/2003 Cetera
- D483,805 S 12/2003 Ikeda
- D495,362 S 8/2004 Qiu

- D504,187 S 4/2005 Man
- D506,498 S * 6/2005 Huang et al. D19/36
- D508,714 S 8/2005 Koch
- D534,587 S 1/2007 Hageman
- D541,858 S 5/2007 Yeh
- D546,879 S 7/2007 Qiu

(Continued)

Primary Examiner—Elizabeth A Albert
Assistant Examiner—Karen E Eldridge Powers
(74) *Attorney, Agent, or Firm*—Christensen O'Connor
Johnson Kindness PLLC

(57) **CLAIM**

The ornamental design for a marker, as shown and described.

DESCRIPTION

FIG. 1 is an upper front right perspective view of a marker showing my new design;
FIG. 2 is a lower front left perspective view of the marker shown in FIG. 1, with the cap removed and placed in the bottom of the marker;
FIG. 3 is a right side elevation view of the marker shown in FIG. 1, with the left side elevation view being a mirror image of the right side elevation view;
FIG. 4 is a front elevation view thereof, with the rear elevation view being a mirror image of the front elevation view;
FIG. 5 is an enlarged bottom plan view thereof; and,
FIG. 6 is an enlarged top plan view thereof.
The feature shown in broken lines in FIG. 5 is included for the purpose of illustrating environment and forms no part of the claimed design.

1 Claim, 4 Drawing Sheets

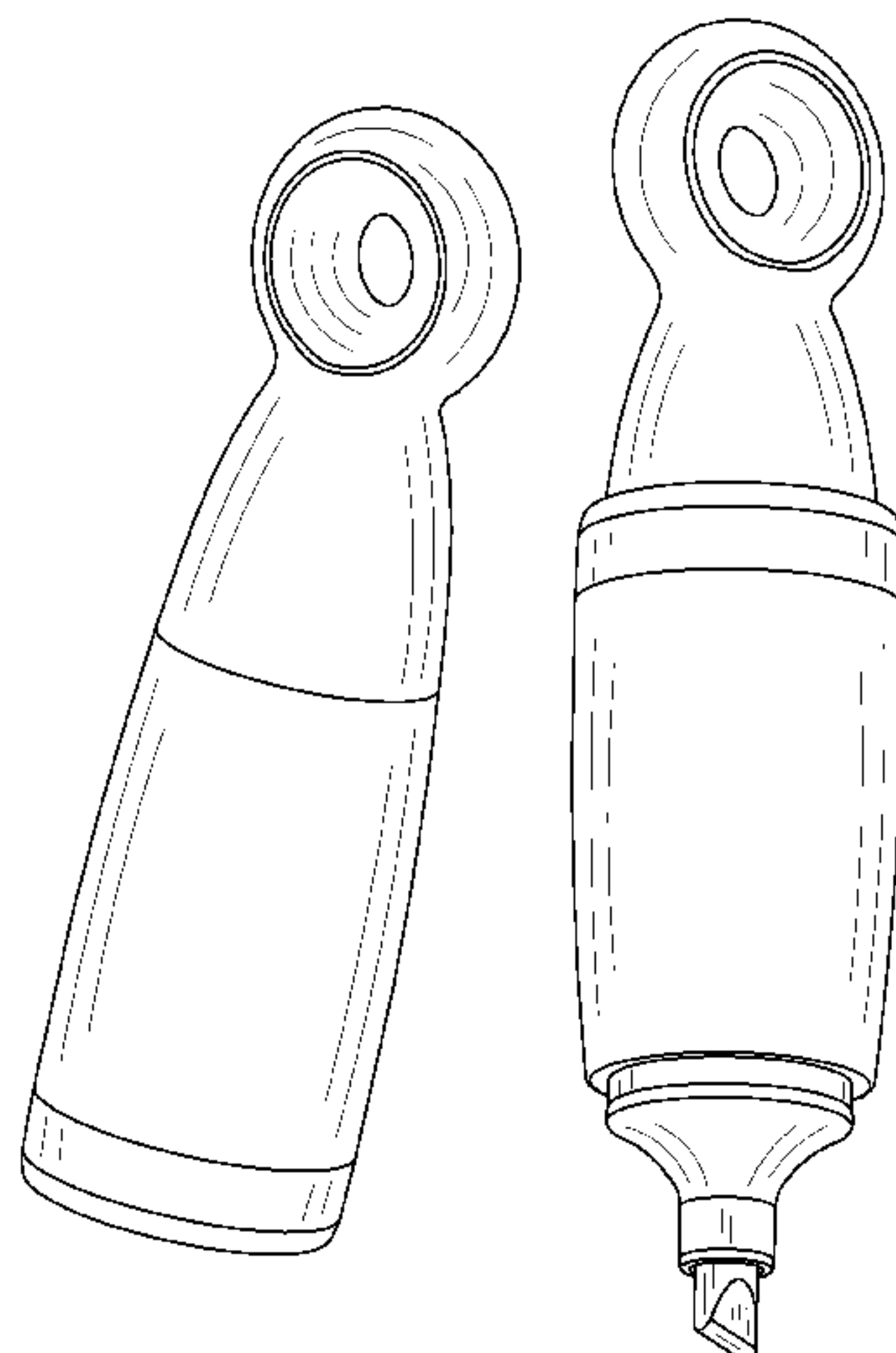

US D628,632 S

Page 2

U.S. PATENT DOCUMENTS

D551,295 S	9/2007	Chen	D573,643 S	7/2008	Brigham
D551,369 S	9/2007	Mah	D575,824 S	8/2008	Koch
D562,892 S	2/2008	Qiu	D576,210 S	9/2008	Qiu
D563,469 S	3/2008	Qiu	D583,411 S	12/2008	Zhao
D566,175 S	4/2008	Qiu	D583,412 S	12/2008	Li
D566,360 S	4/2008	Ungaro	D590,877 S	4/2009	Ma
D569,905 S	5/2008	Qiu	D591,345 S	4/2009	Yu
D572,755 S	7/2008	Brigham	D607,930 S	1/2010	Liu
			D607,931 S	1/2010	Liu

* cited by examiner

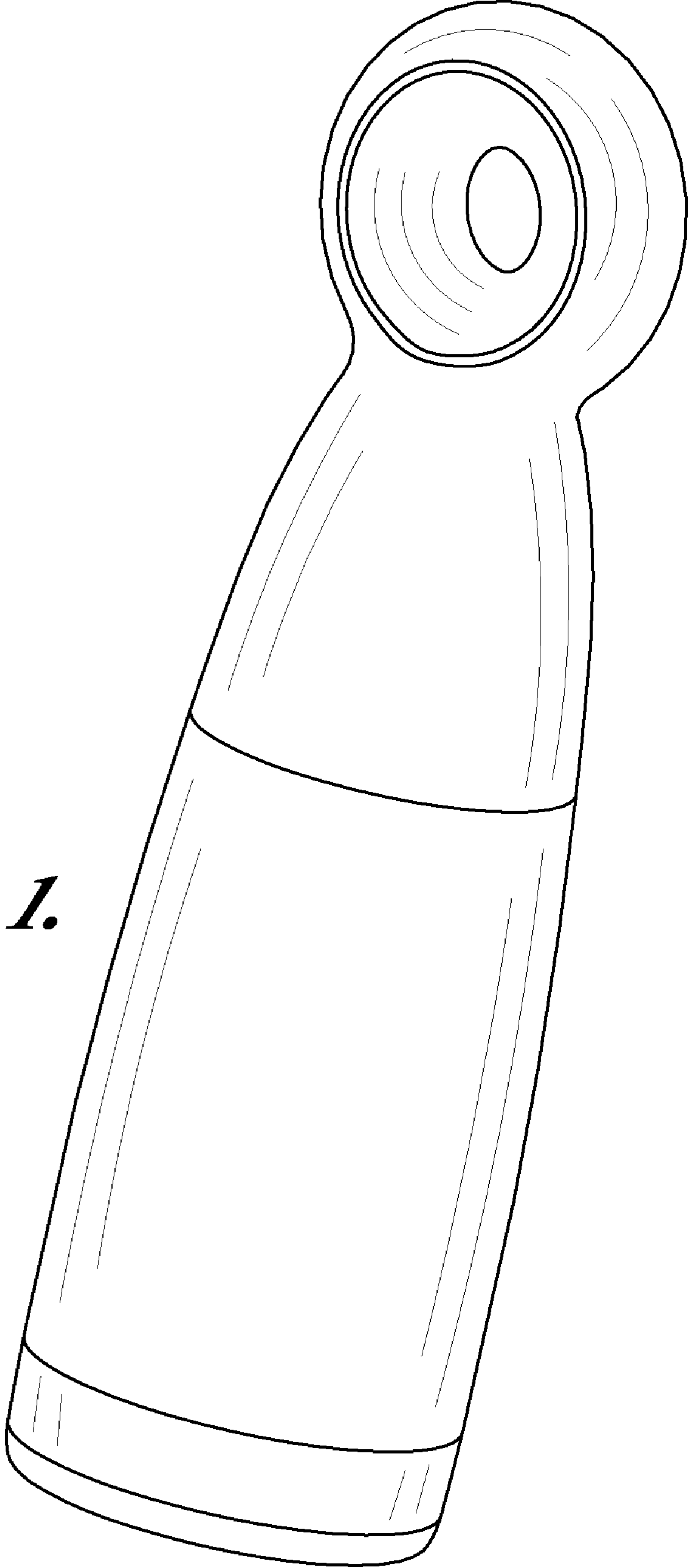
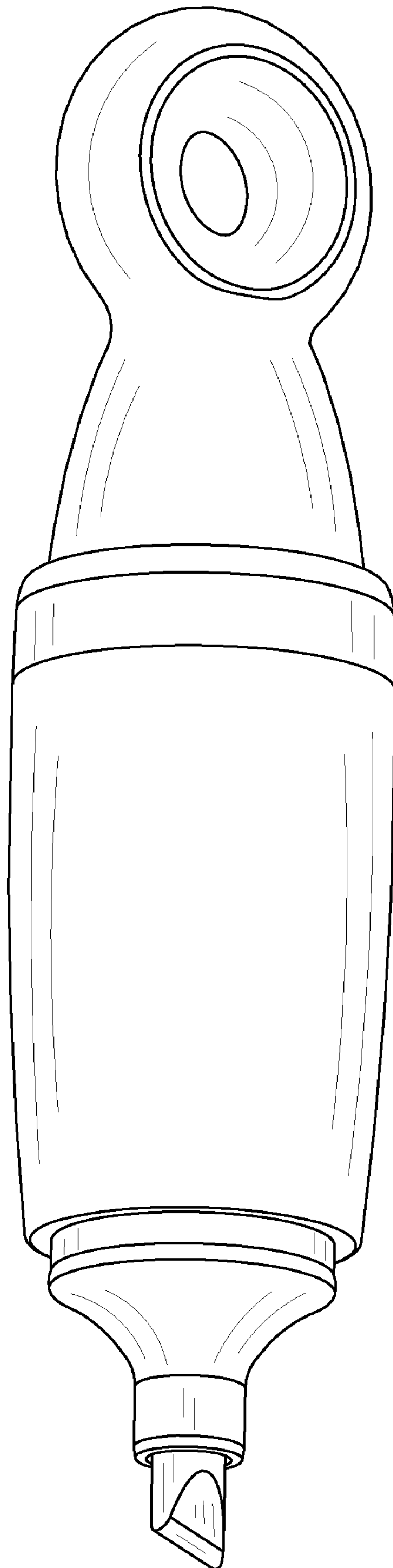

Fig.1.

Fig. 2.



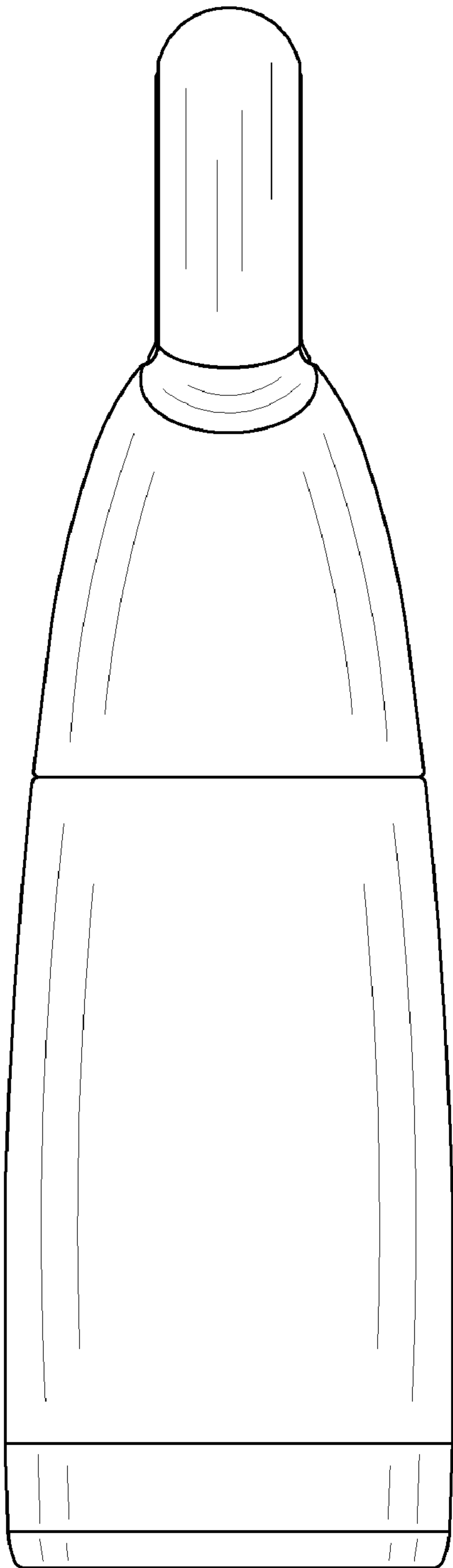

Fig.3.

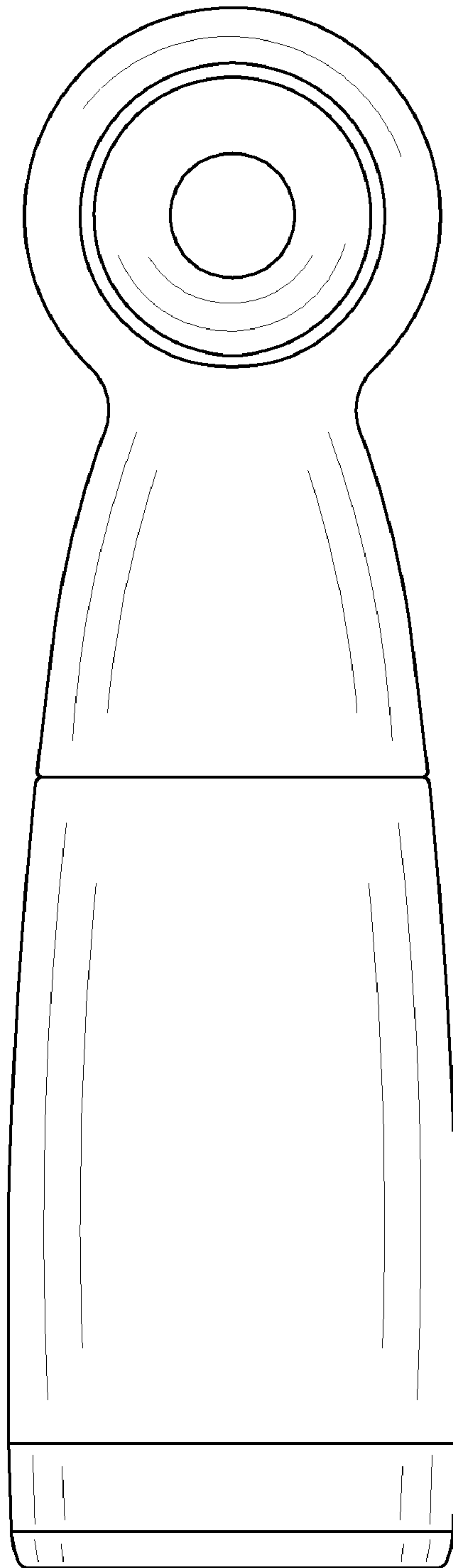

Fig.4.

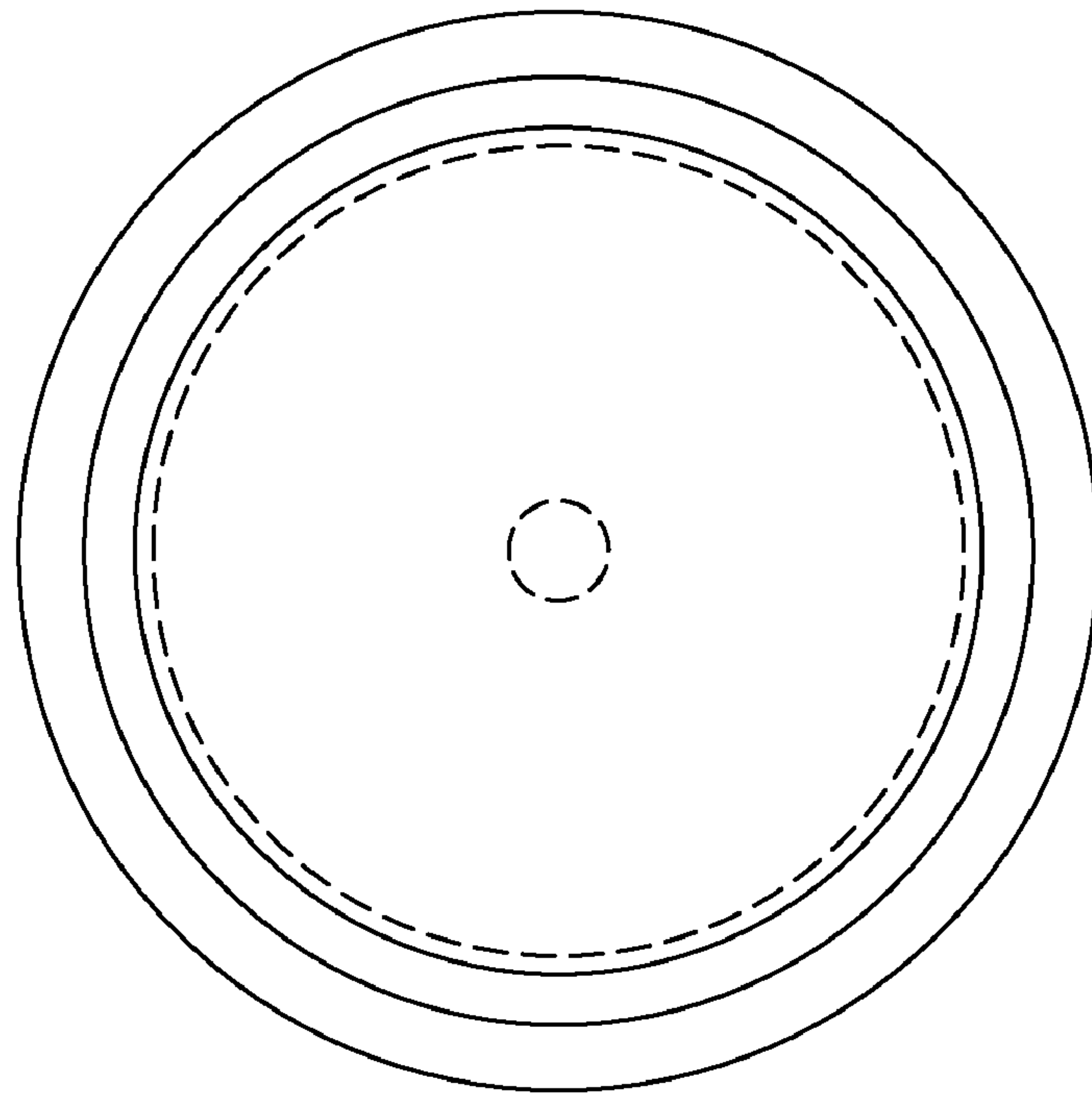

Fig. 5.

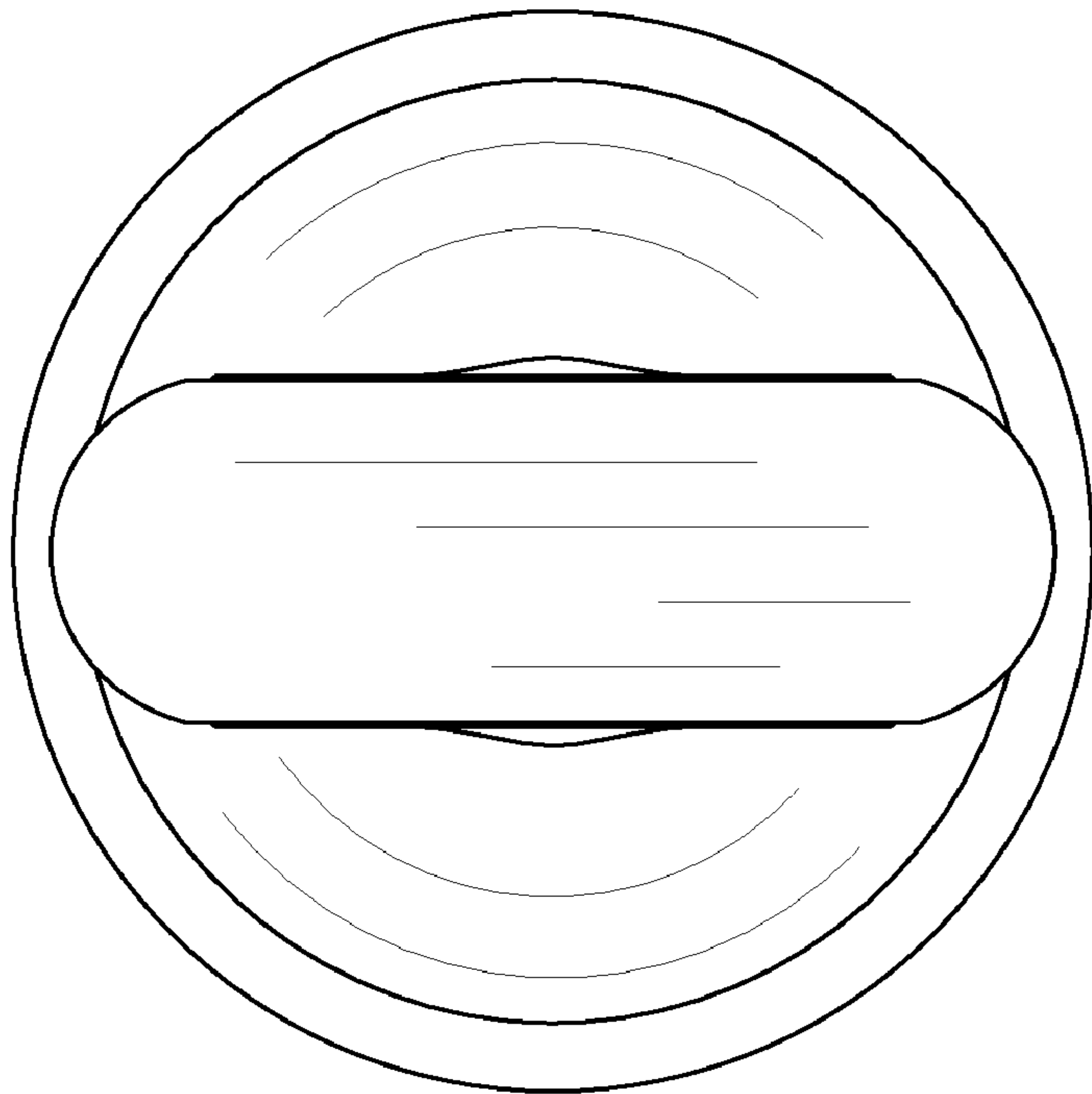

Fig. 6.