



US00D628616S

(12) **United States Design Patent**
Yuan

(10) **Patent No.:** **US D628,616 S**
(45) **Date of Patent:** **** Dec. 7, 2010**

(54) **3D GLASSES**

(75) Inventor: **Dingwen Yuan**, Hunan Province (CN)

(73) Assignee: **Hi-Shock Digital Electronics Technologies Co., Ltd.**, Guangdong Province (CN)

(**) Term: **14 Years**

(21) Appl. No.: **29/361,723**

(22) Filed: **May 14, 2010**

(51) **LOC (9) Cl.** **16-06**

(52) **U.S. Cl.** **D16/306; D16/311; D16/326**

(58) **Field of Classification Search** D16/101, D16/300-342; D29/109-110; D24/110.2; 351/41, 44, 51-52, 62, 158, 92, 103-123, 351/140, 153, 45-46; 2/426-432, 447-449, 2/441, 434-437, 13, 15; D21/483, 659-661
See application file for complete search history.

(56) **References Cited**

U.S. PATENT DOCUMENTS

D552,155 S * 10/2007 Markovitz D16/326

D561,810 S * 2/2008 Fox et al. D16/325
D600,738 S * 9/2009 Su et al. D16/300
D603,445 S * 11/2009 Carlow et al. D16/325
D613,328 S * 4/2010 Carlow et al. D16/300
D616,486 S * 5/2010 Carlow et al. D16/325

* cited by examiner

Primary Examiner—Raphael Barkai

(57) **CLAIM**

The ornamental design for a 3D glasses, as shown and described.

DESCRIPTION

FIG. 1 is a front, top and right side perspective view of a 3D glasses showing our new design;
FIG. 2 is a front elevational view thereof;
FIG. 3 is a rear elevational view thereof;
FIG. 4 is a side elevational view thereof;
FIG. 5 is a top plan view thereof; and,
FIG. 6 is a bottom plan view thereof.

1 Claim, 4 Drawing Sheets

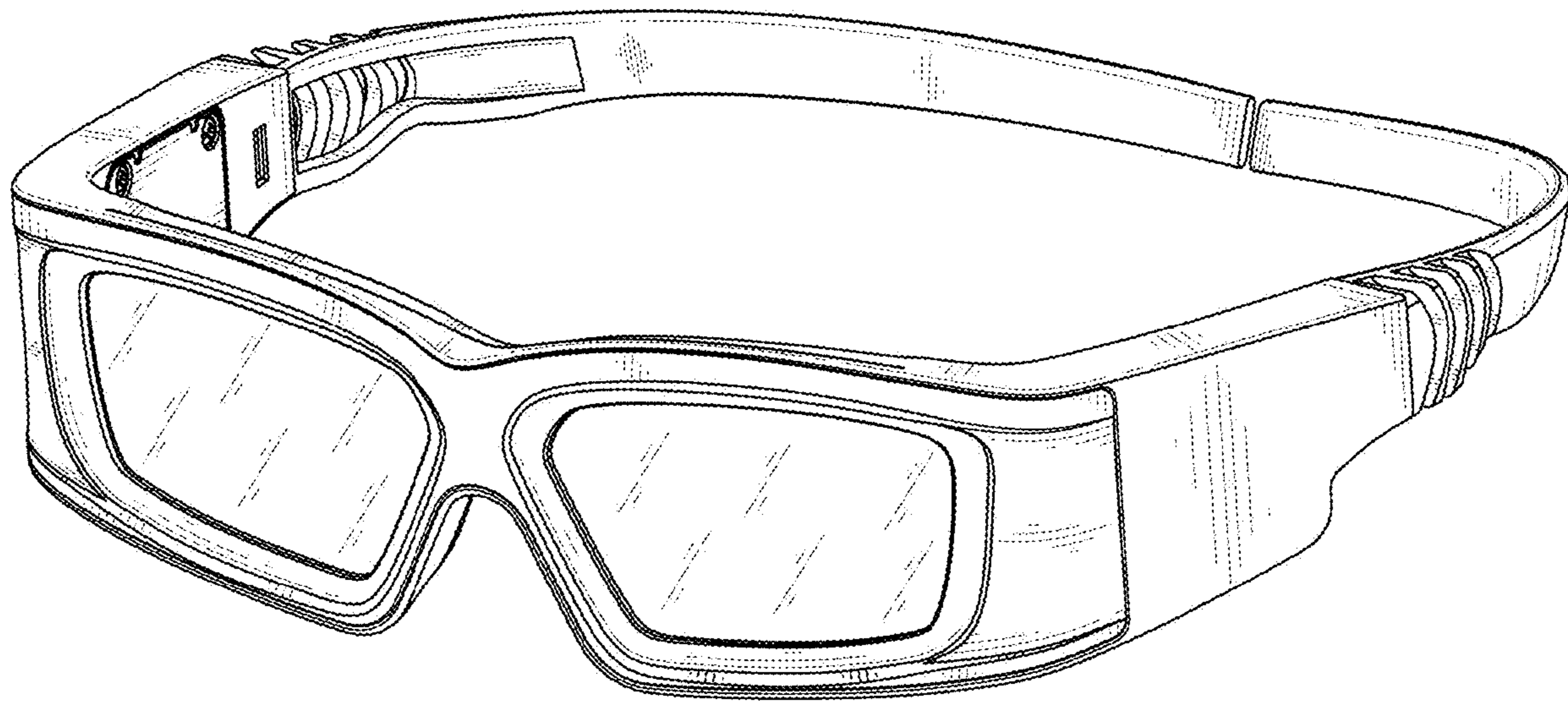

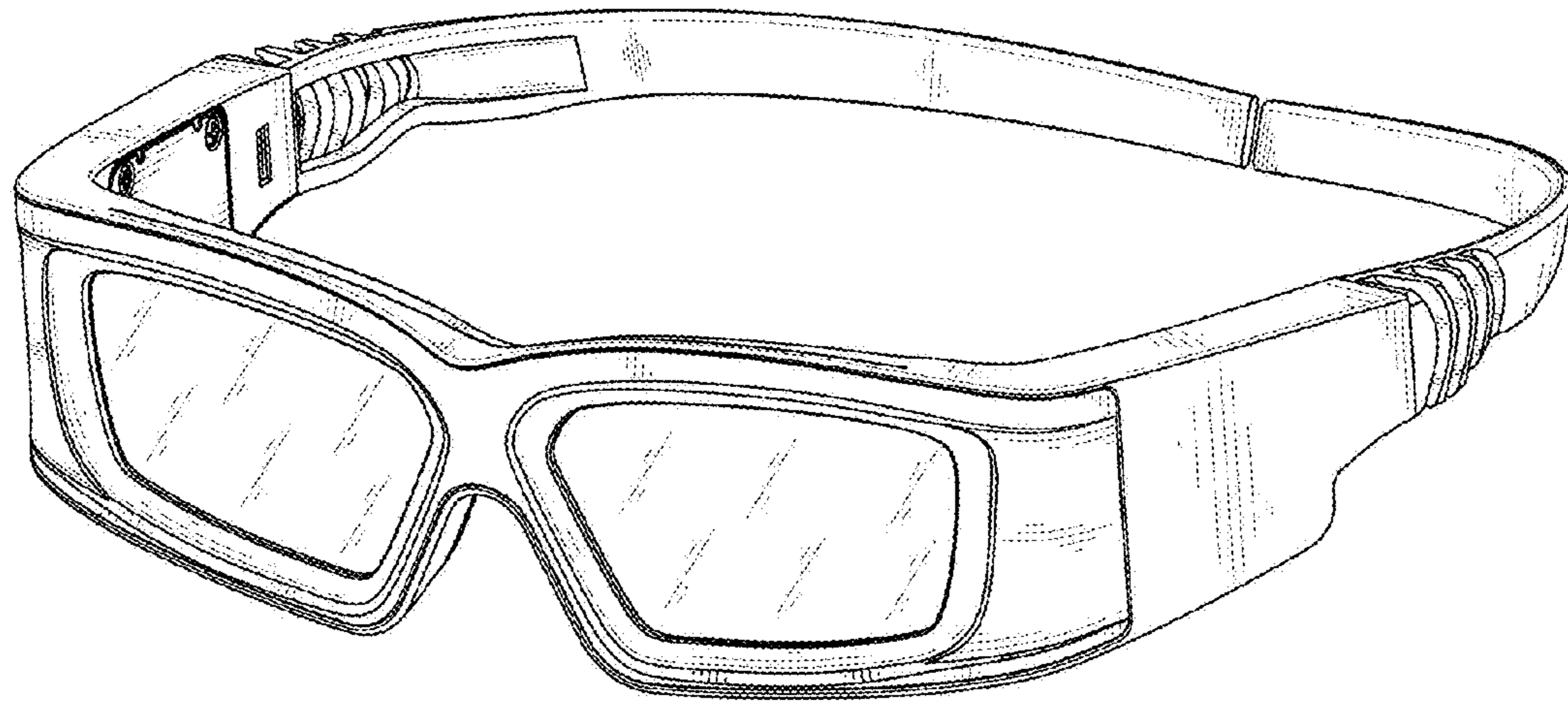

FIG. 1

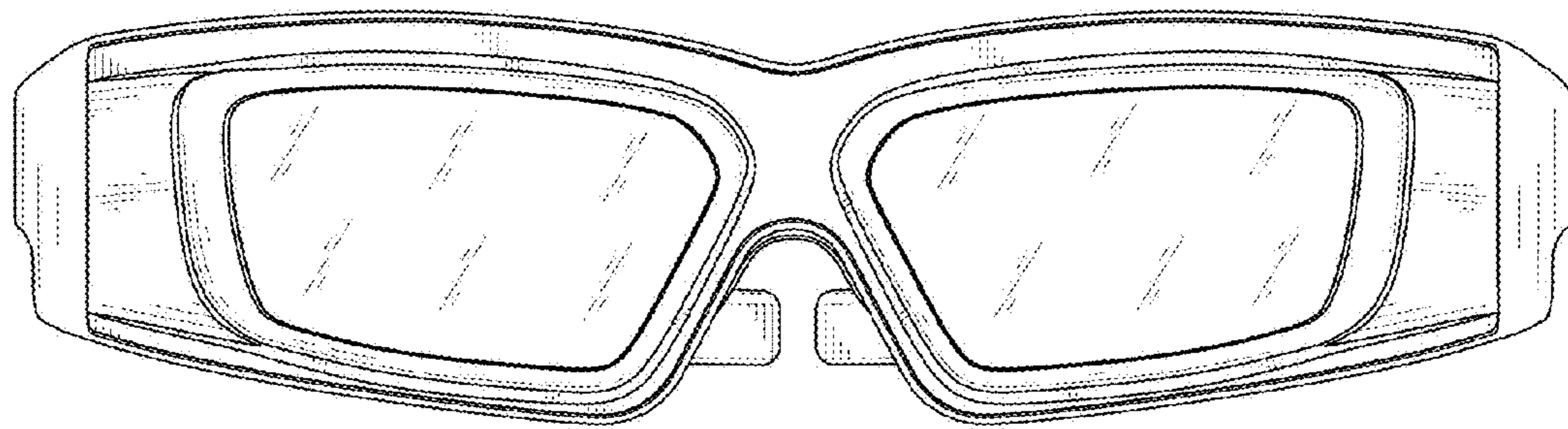

FIG. 2

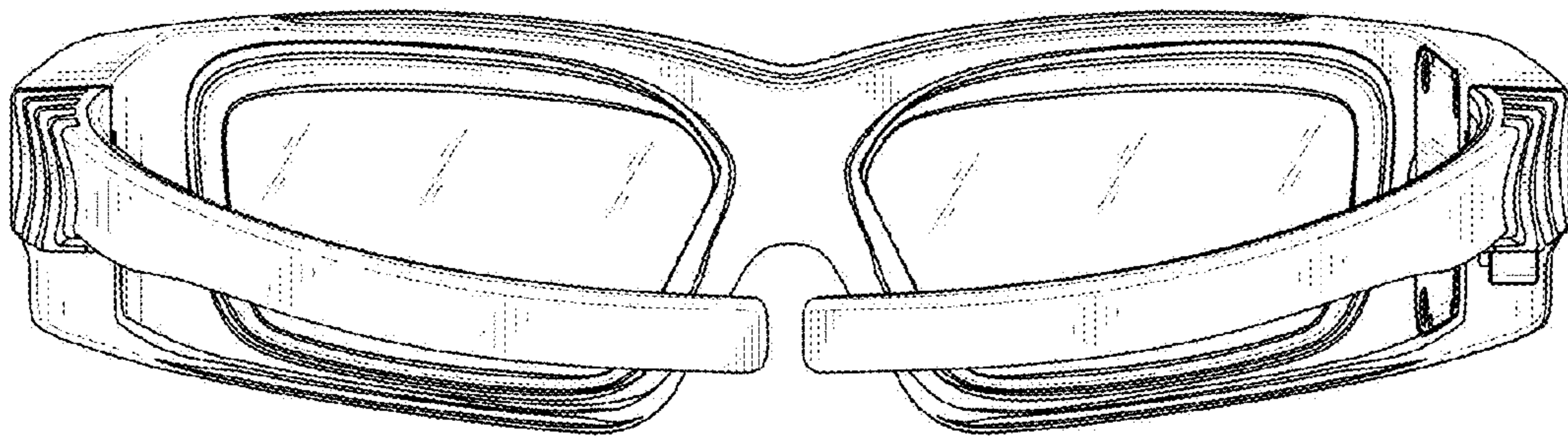

FIG. 3

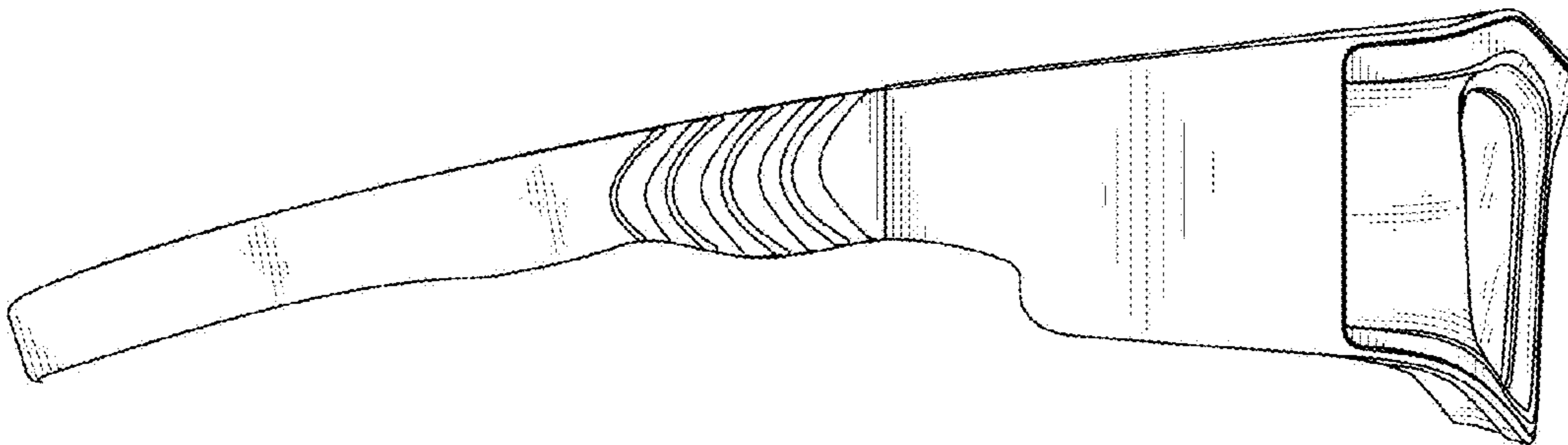

FIG. 4

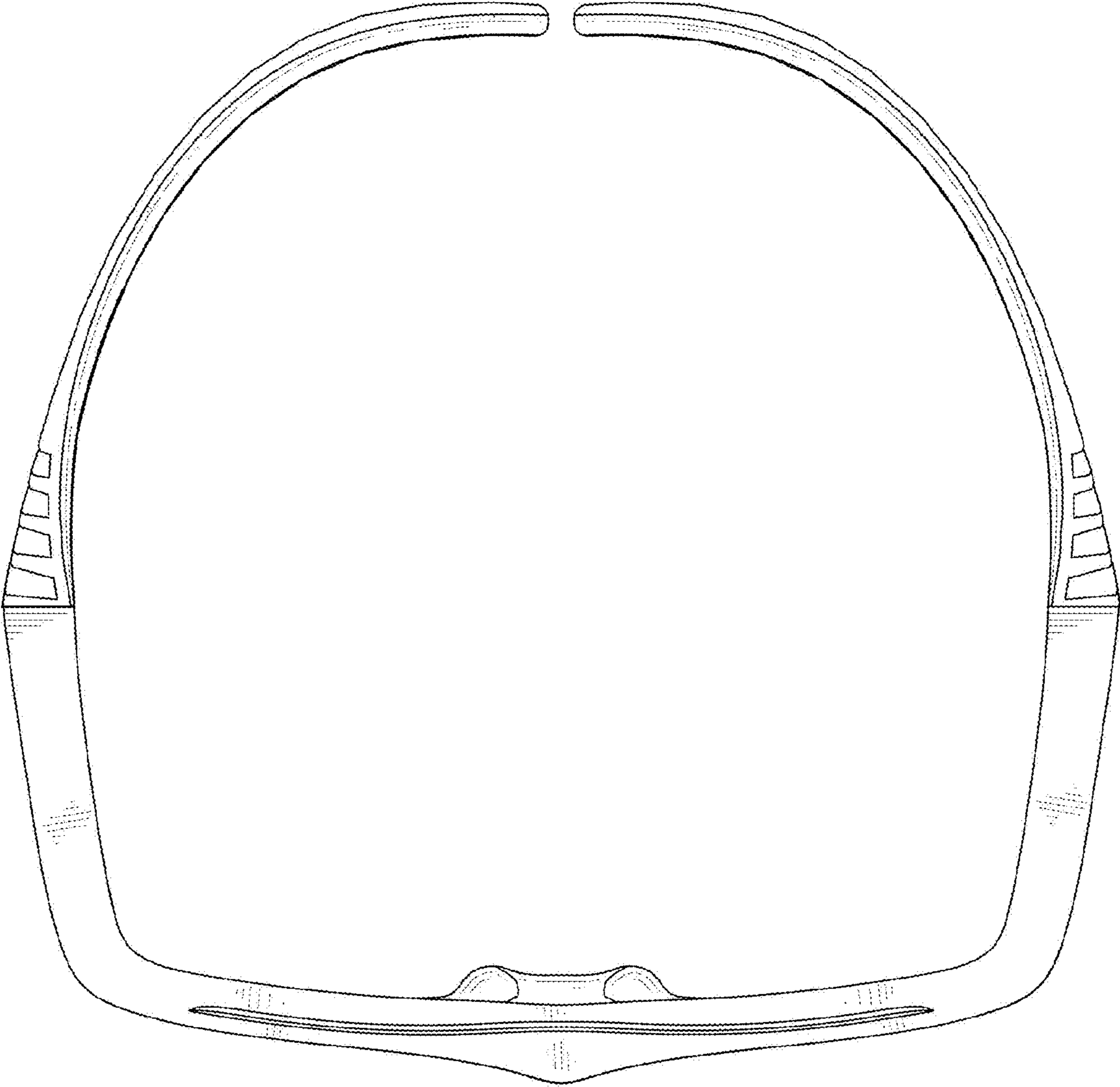

FIG. 5

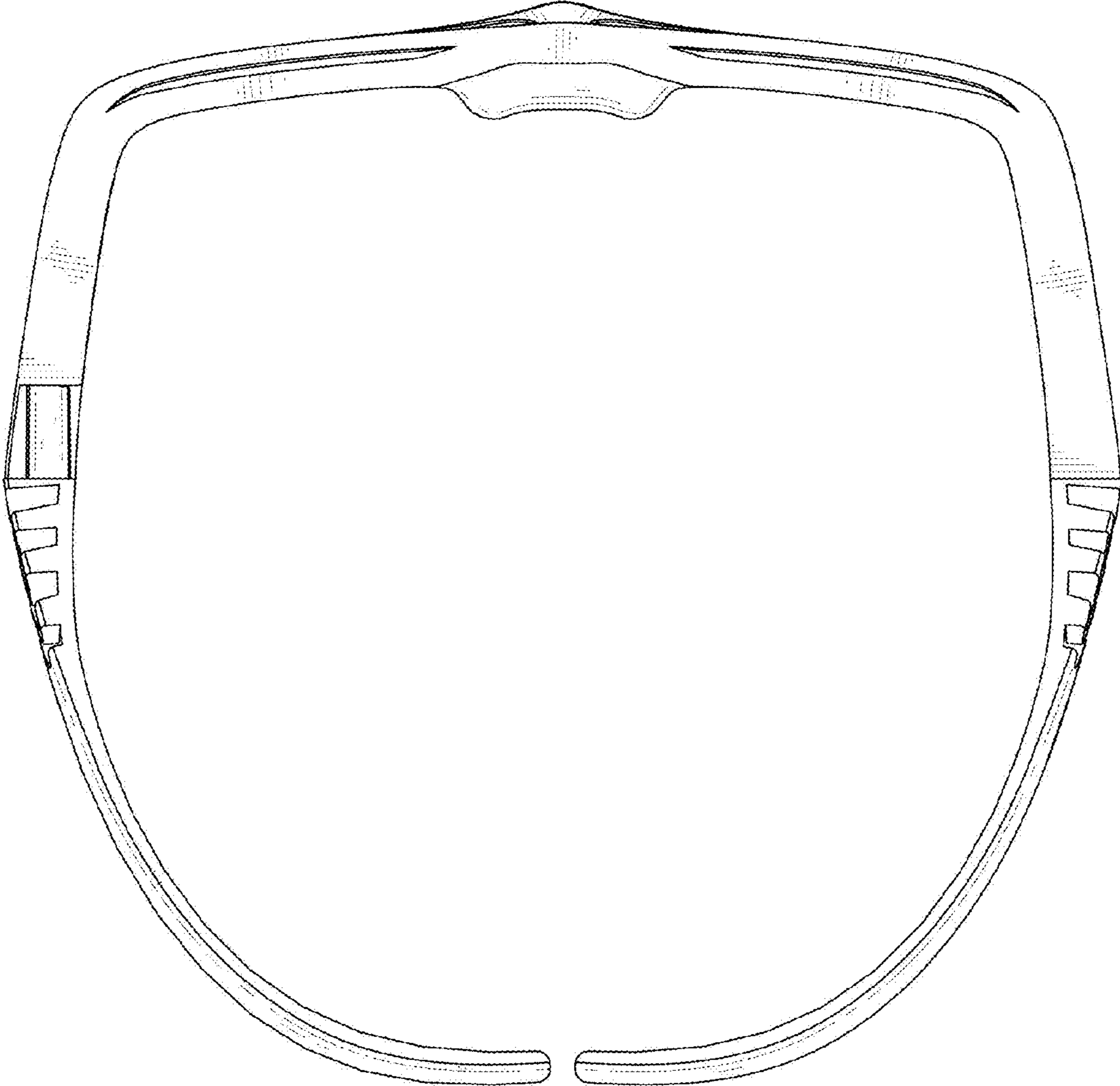

FIG. 6