



US00D628579S

(12) **United States Design Patent**
Landry et al.

(10) **Patent No.:** **US D628,579 S**
(45) **Date of Patent:** **** Dec. 7, 2010**

(54) **USB DEVICE AND STAND UNIT**

(75) Inventors: **Christian C Landry**, Harvard, MA (US); **Sandro David Klein**, Cypress, CA (US); **Hungbing Chen**, Tustin, CA (US); **Daniel K Harden**, Palo Alto, CA (US); **Hiroto Teranishi**, Palo Alto, CA (US); **David S Benavidez**, Santa Clara, CA (US)

(73) Assignee: **Cisco Technology, Inc.**, San Jose, CA (US)

(**) Term: **14 Years**

(21) Appl. No.: **29/359,025**

(22) Filed: **Apr. 5, 2010**

Related U.S. Application Data

(63) Continuation of application No. 29/326,346, filed on Oct. 16, 2008, now Pat. No. Des. 615,985.

(51) **LOC (9) Cl.** **14-02**

(52) **U.S. Cl.** **D14/480.5**

(58) **Field of Classification Search** D14/411, D14/433, 435.1, 436, 480.1–480.7, 484.1, D14/137, 155, 167, 168, 203.1–203.8, 240, D14/242, 299, 447, 451; D3/201, 273; D13/107, D13/108, 149, 184; 361/679.31, 679.33, 361/679.4, 752; 711/100, 115; 710/300, 710/301; 439/131, 135–147

See application file for complete search history.

(56) **References Cited**

U.S. PATENT DOCUMENTS

- D288,317 S 2/1987 Yuen
- D351,381 S 10/1994 Reardon et al.
- D420,348 S 2/2000 Chang
- D446,511 S 8/2001 Kanno et al.
- D479,712 S 9/2003 Ng
- D485,269 S 1/2004 Jones et al.
- D514,560 S 2/2006 Brown et al.

- D529,878 S 10/2006 Wang
- D535,993 S * 1/2007 Ueda D14/383
- D544,480 S 6/2007 Murakami
- D554,119 S 10/2007 Otsuka et al.
- D567,239 S 4/2008 Perrier et al.
- D573,594 S 7/2008 Hsu

(Continued)

Primary Examiner—Cathron C Brooks

Assistant Examiner—Karen E Kearney

(74) *Attorney, Agent, or Firm*—Haynes and Boone, LLP.

(57) **CLAIM**

The ornamental design for a USB device and stand unit, as shown and described.

DESCRIPTION

FIG. 1 is a top perspective view showing our new USB device and stand unit, showing the USB device separately for completeness of illustration;

FIG. 2 is a top view thereof;

FIG. 3 is a side view thereof;

FIG. 4 is a bottom view thereof;

FIG. 5 is a bottom perspective view thereof;

FIG. 6 is a front view thereof;

FIG. 7 is a back view thereof;

FIG. 8 is a front perspective view showing our new USB device and stand unit design;

FIG. 9 is a front view thereof;

FIG. 10 is a side view thereof;

FIG. 11 is a top view thereof;

FIG. 12 is a bottom view thereof;

FIG. 13 is a back perspective view thereof; and,

FIG. 14 is a back view thereof.

The broken lines shown in the drawings are for the purpose of illustrating unclaimed portions of the USB device and stand unit and form no part of the claimed design.

1 Claim, 10 Drawing Sheets

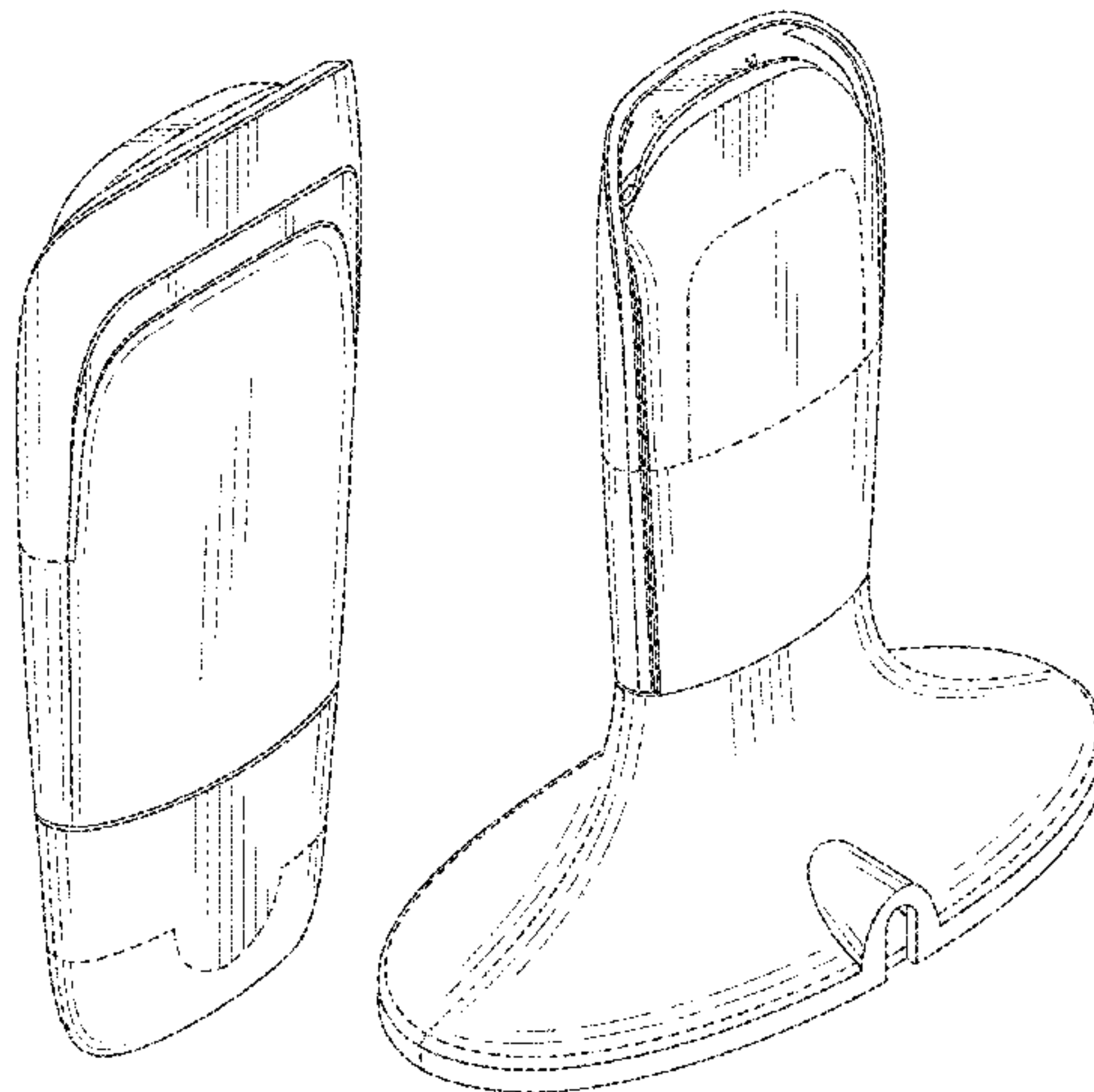

US D628,579 S

Page 2

U.S. PATENT DOCUMENTS

7,568,942	B1 *	8/2009	Lannon et al.	439/521	D606,513	S *	12/2009	Wood et al.	D14/203.7
D599,800	S *	9/2009	Klein et al.	D14/433	D607,462	S *	1/2010	Chen	D14/480.5
D601,152	S *	9/2009	Moshes et al.	D14/480.7	D607,898	S *	1/2010	Lee	D14/496
D601,569	S *	10/2009	Landry et al.	D14/480.5	D610,158	S *	2/2010	Chen	D14/480.7
D602,000	S *	10/2009	Oh et al.	D14/203.7	7,672,122	B2 *	3/2010	Lin et al.	361/679.31
D602,494	S *	10/2009	Lannon et al.	D14/480.5	D615,985	S *	5/2010	Landry et al.	D14/480.5
D602,499	S *	10/2009	Lewis	D14/496	D617,307	S *	6/2010	Wood et al.	D14/203.7
D602,858	S *	10/2009	Ellis et al.	D13/108	D620,017	S *	7/2010	Lo	D14/480.7
D606,512	S *	12/2009	Wood et al.	D14/203.7	2009/0210609	A1 *	8/2009	Learmonth et al.	710/316

* cited by examiner

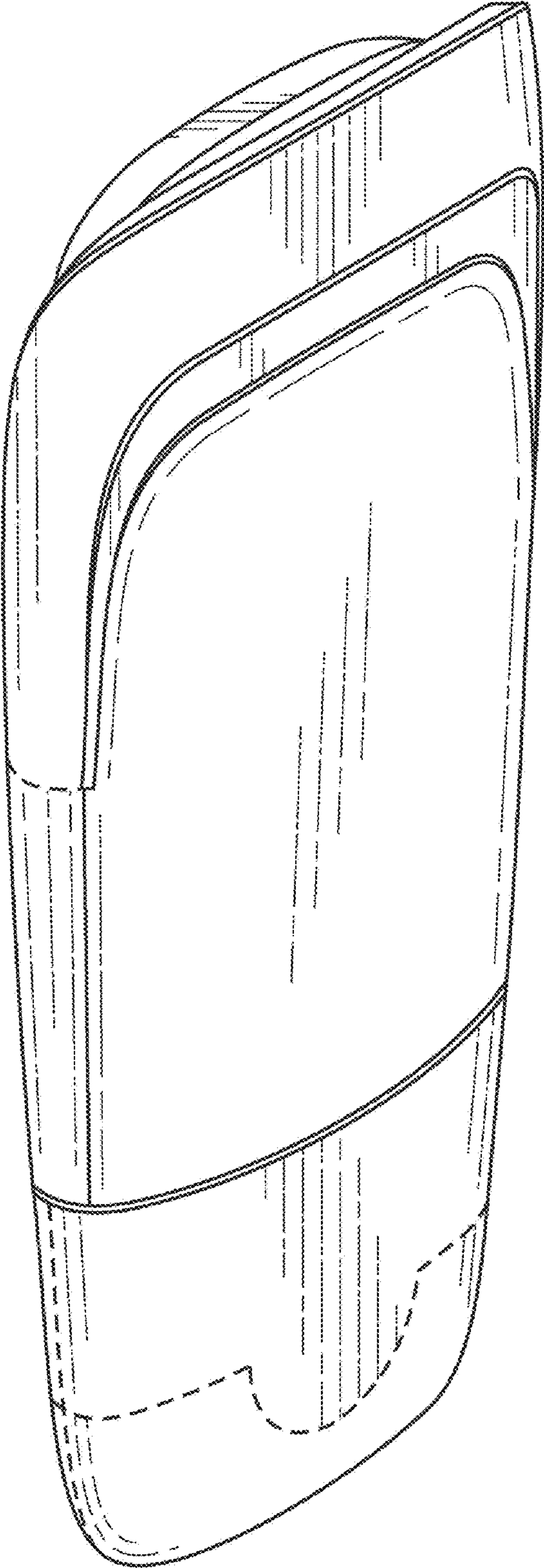

FIG. 1

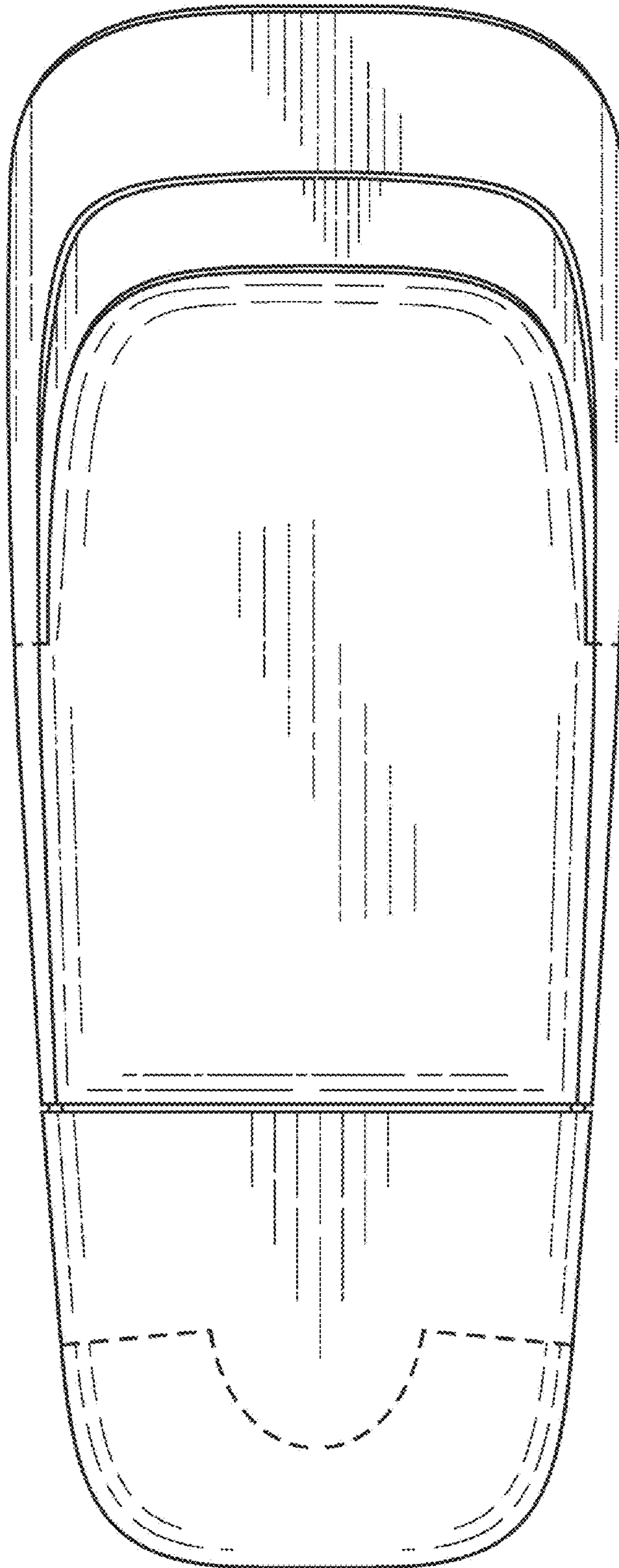

FIG. 2

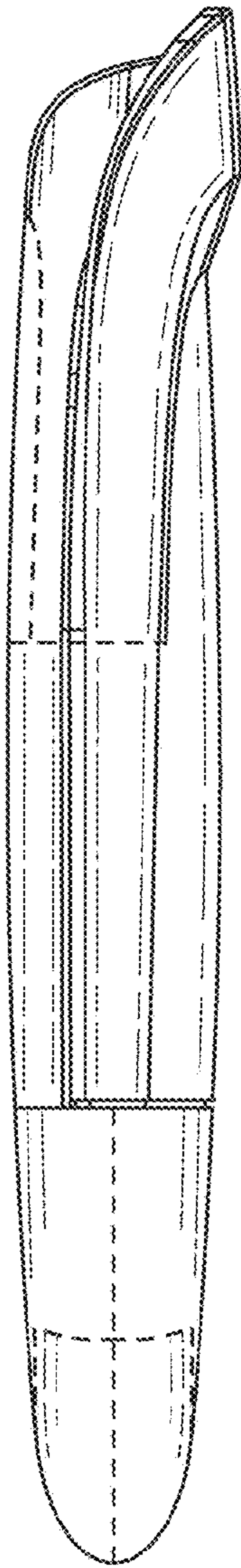

FIG. 3

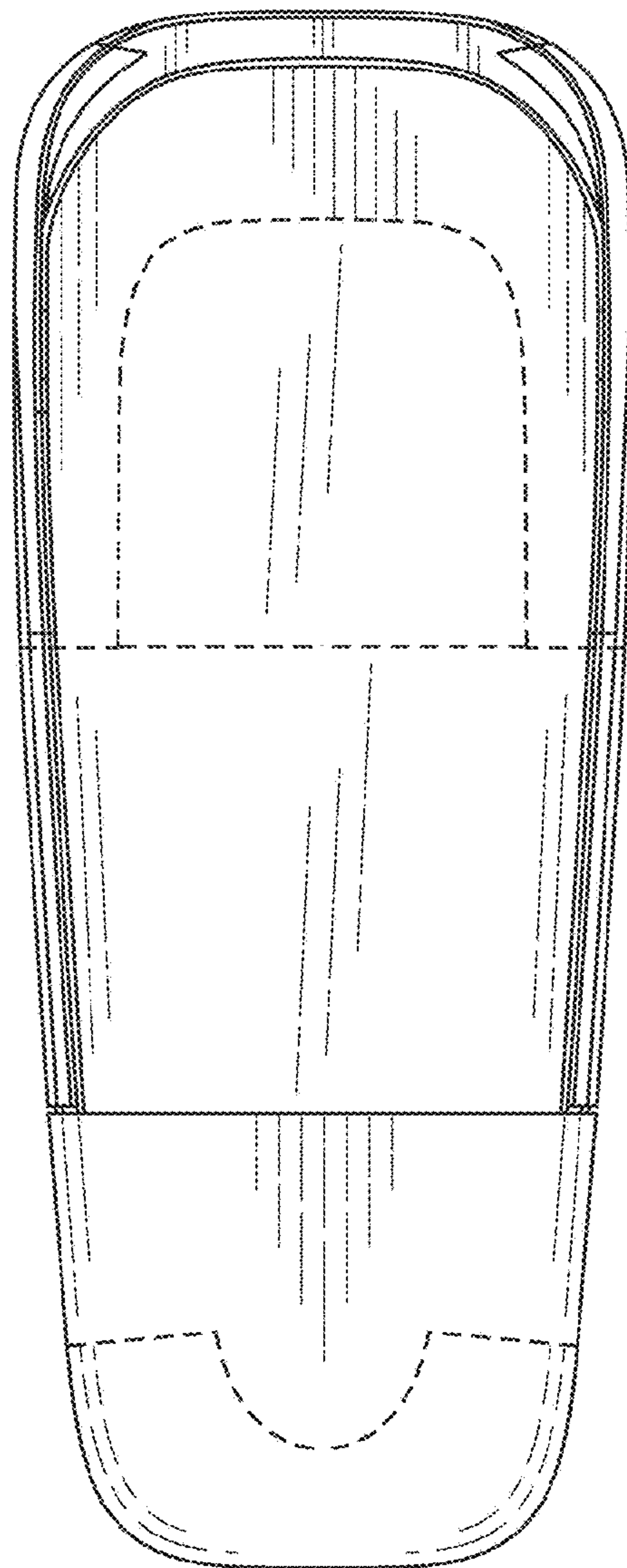

FIG. 4

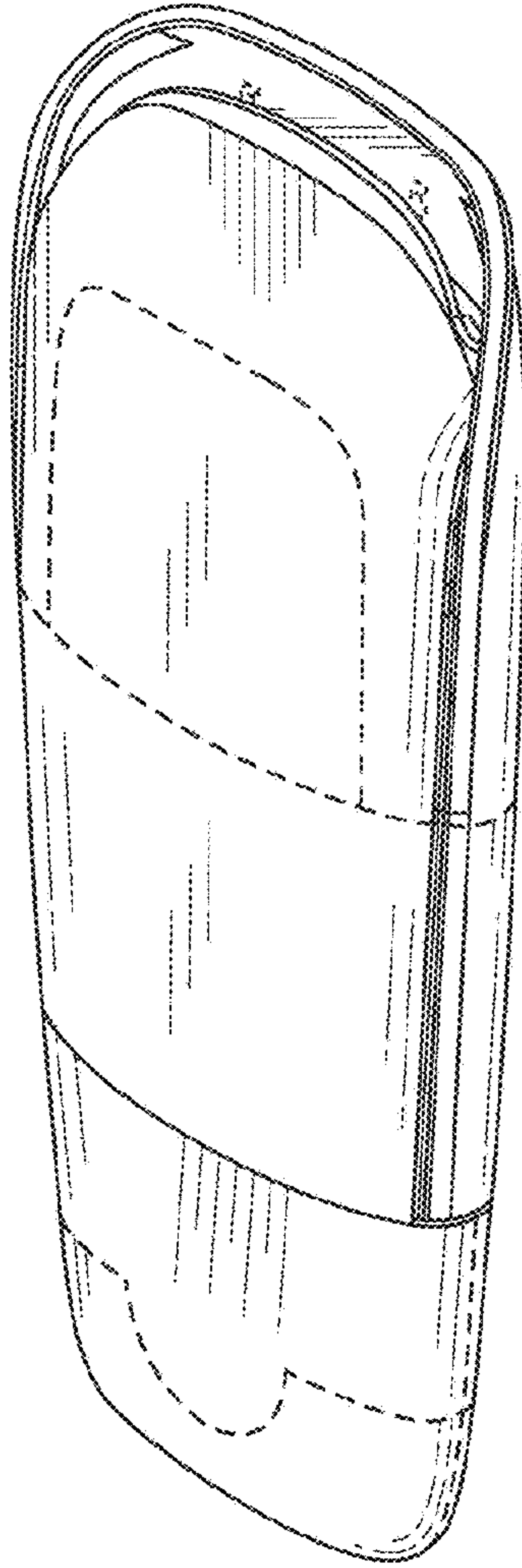

FIG. 5

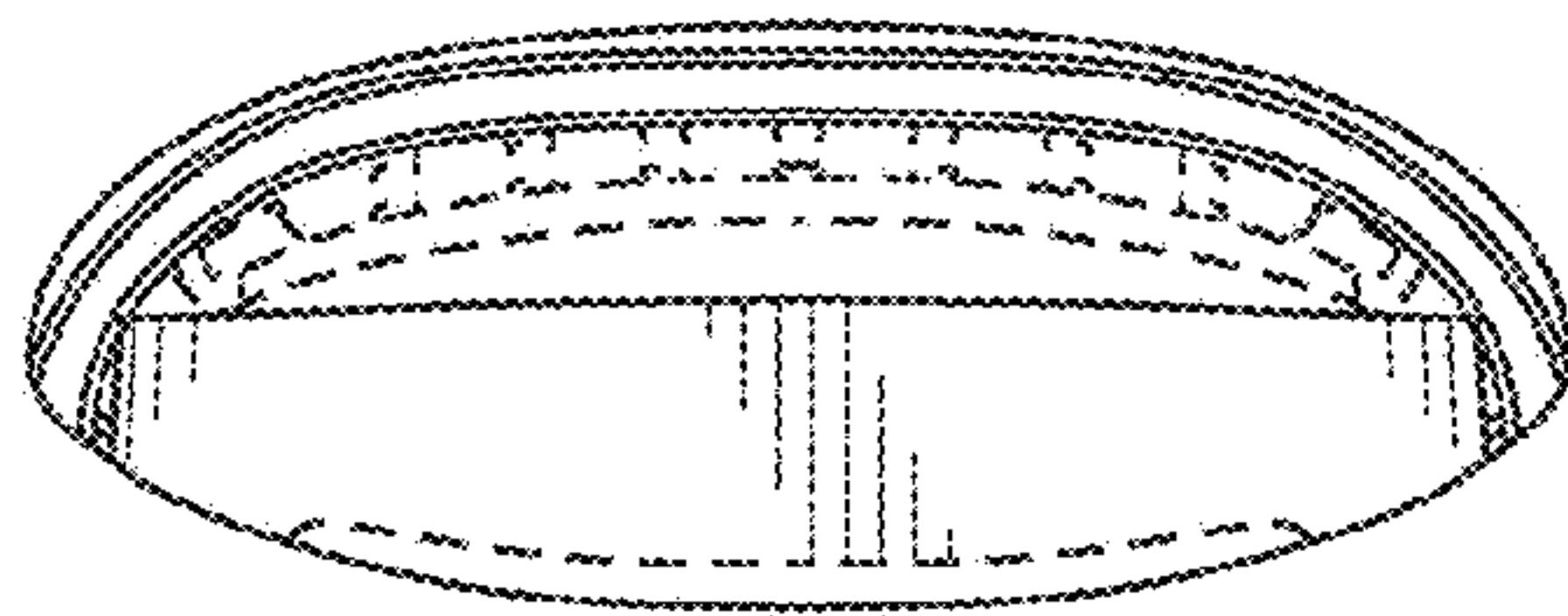

FIG. 6

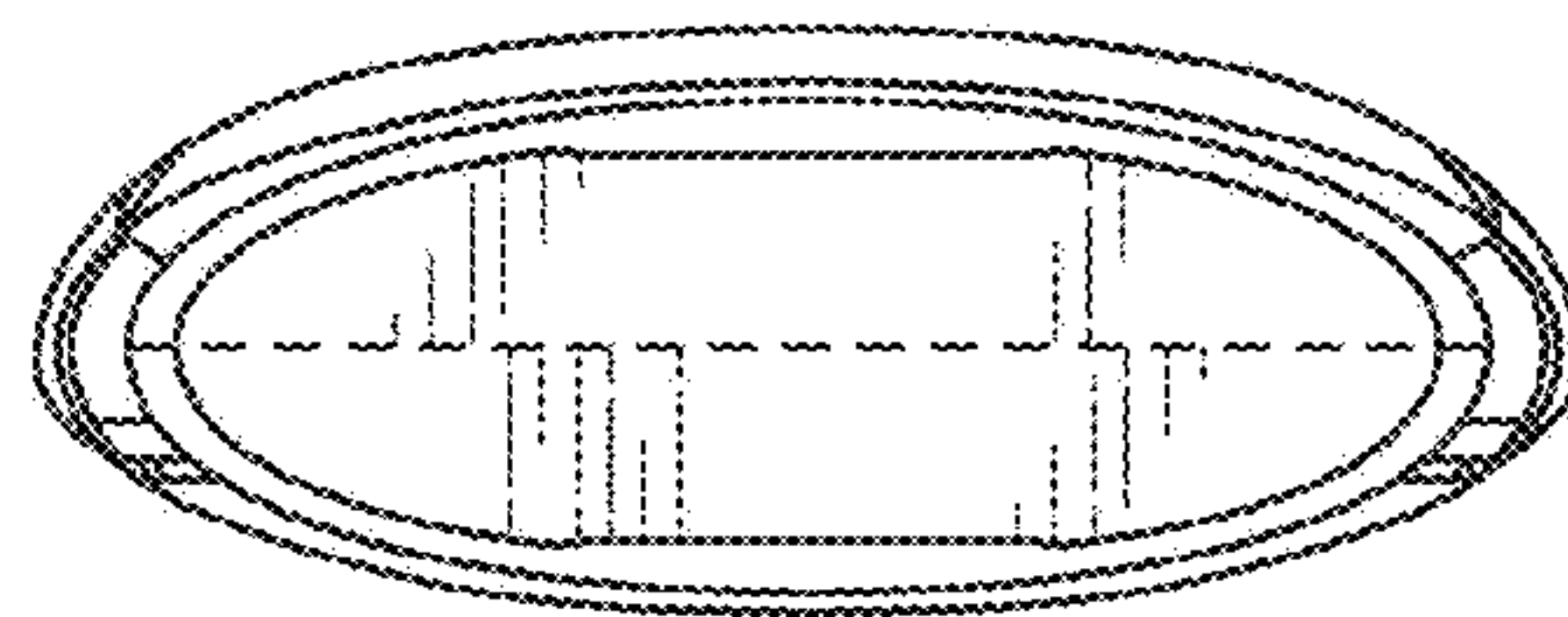

FIG. 7

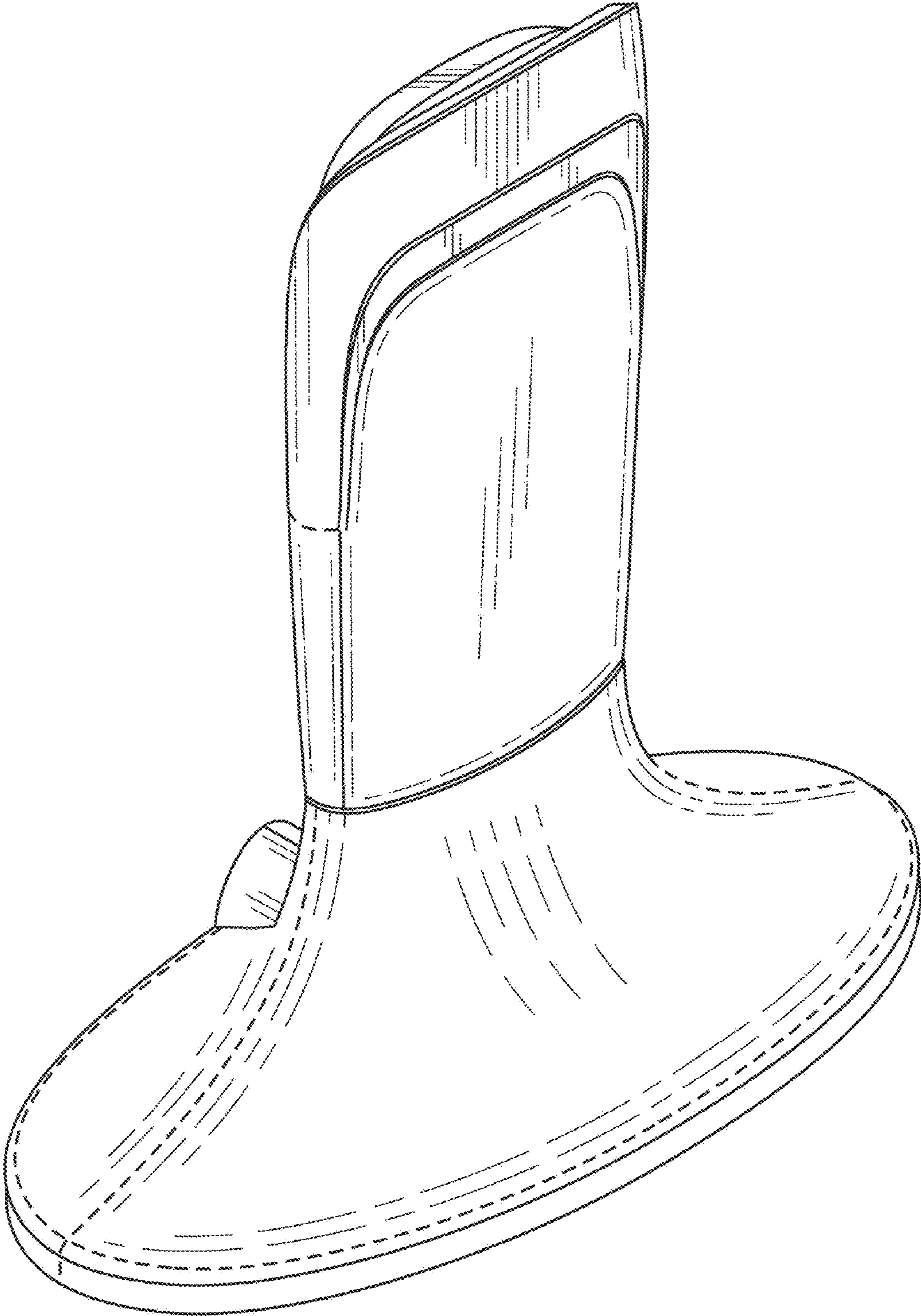

FIG. 8

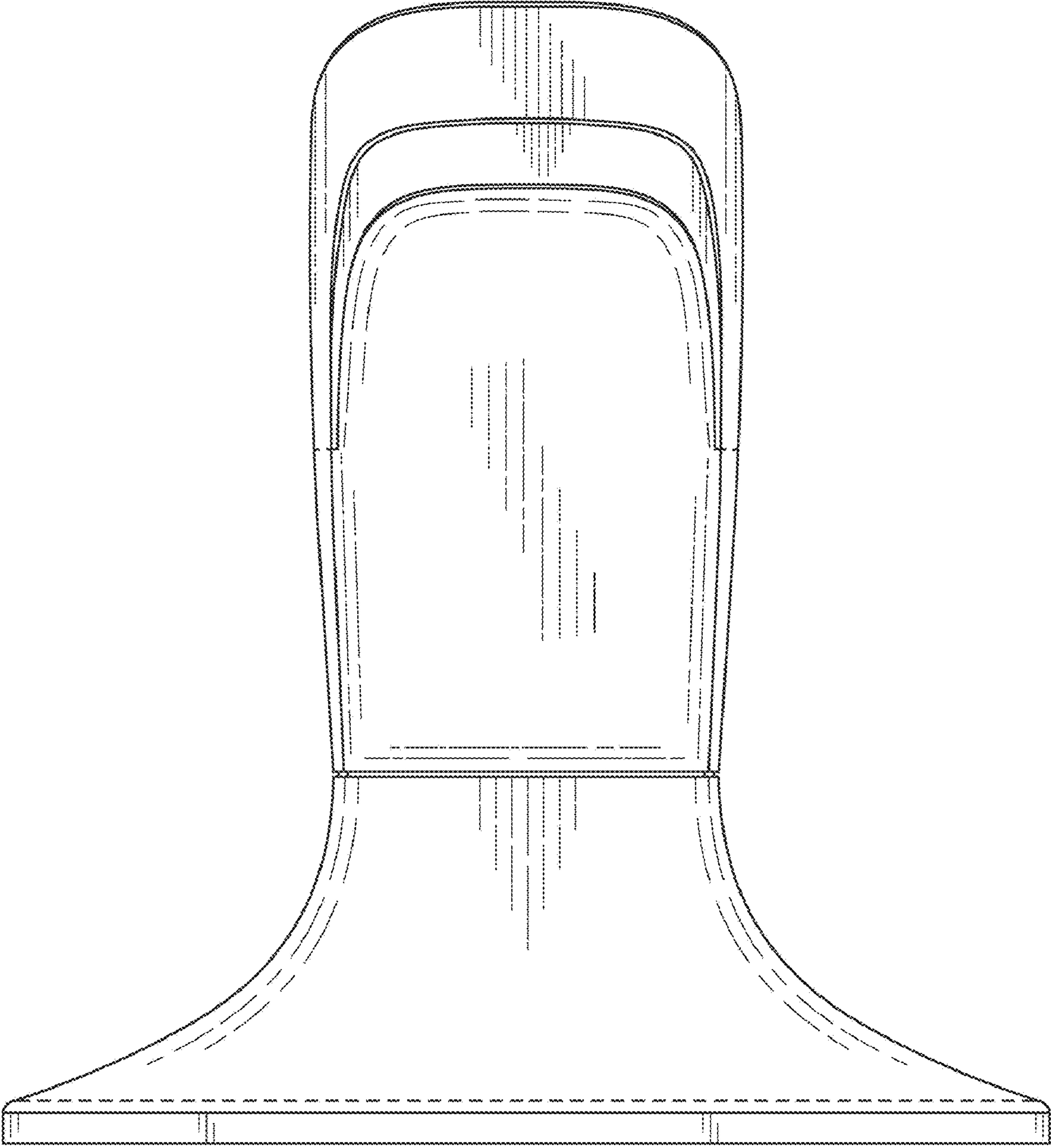

FIG. 9

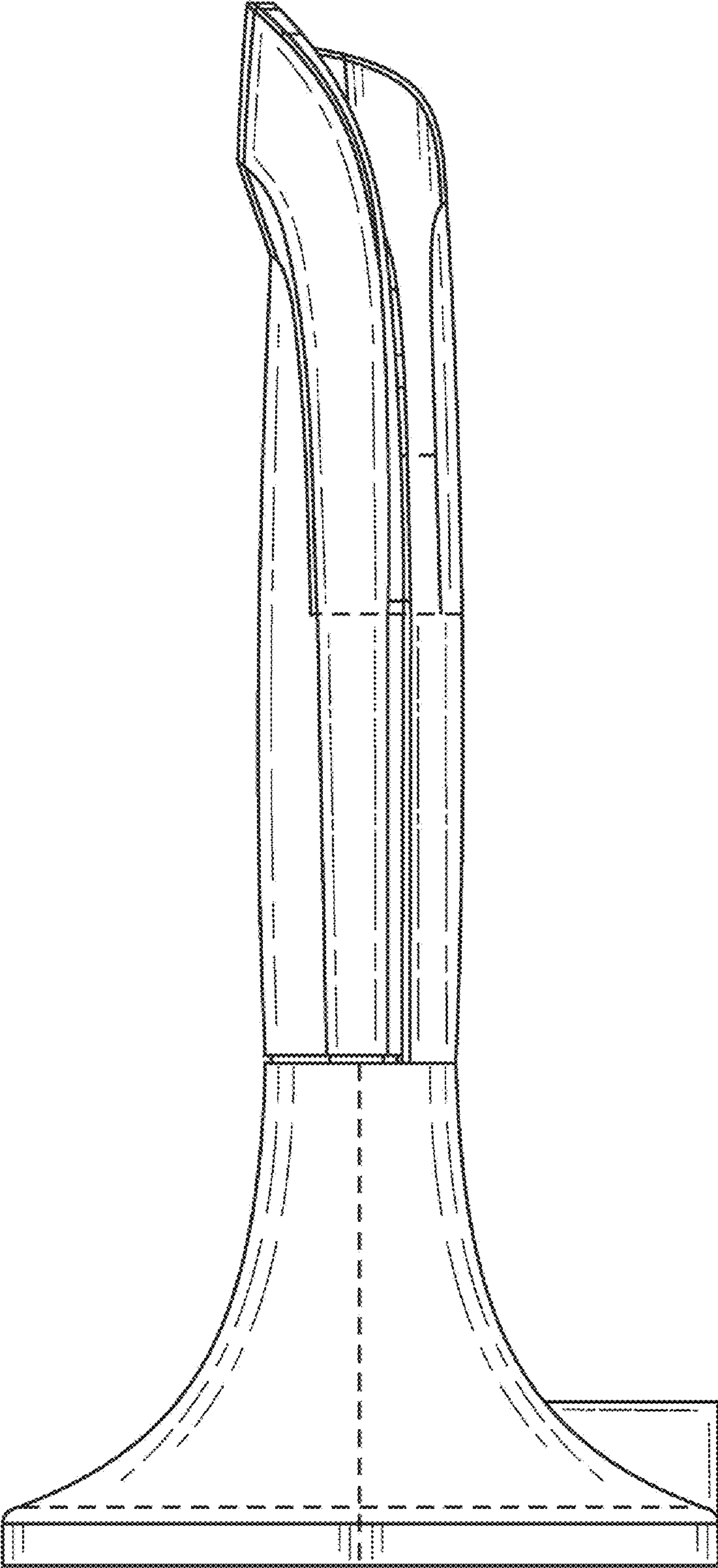

FIG. 10

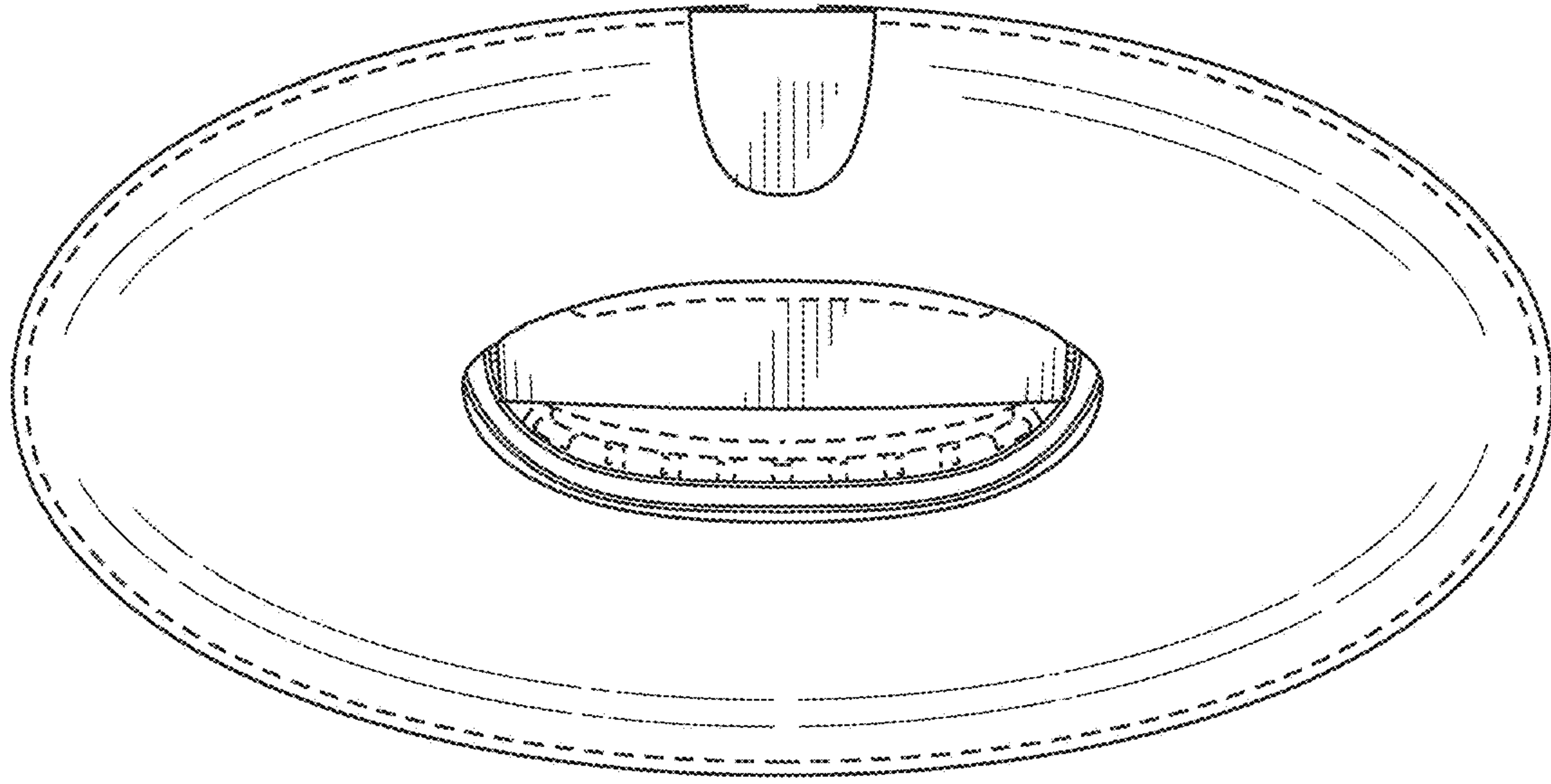

FIG. 11

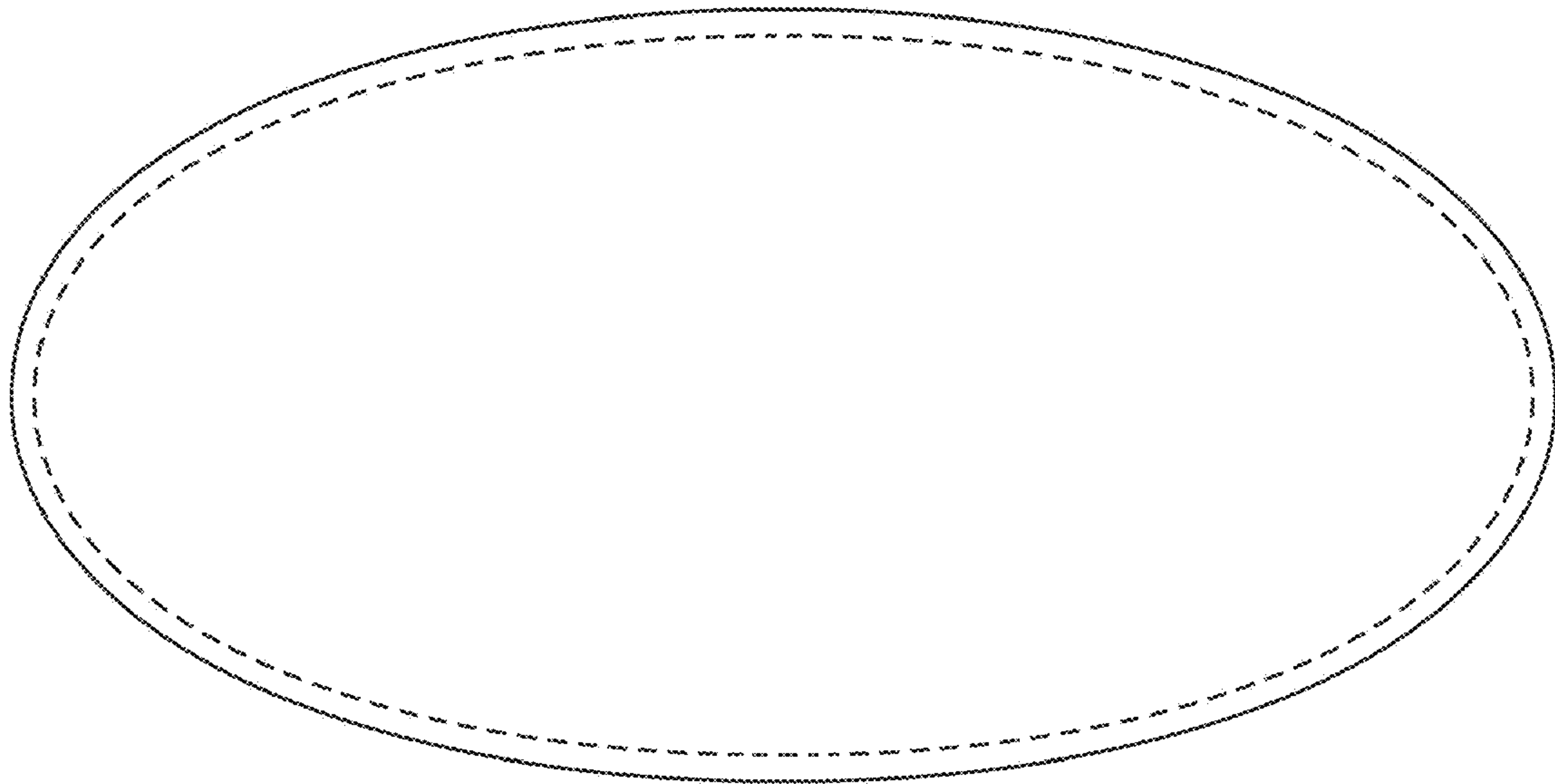

FIG. 12

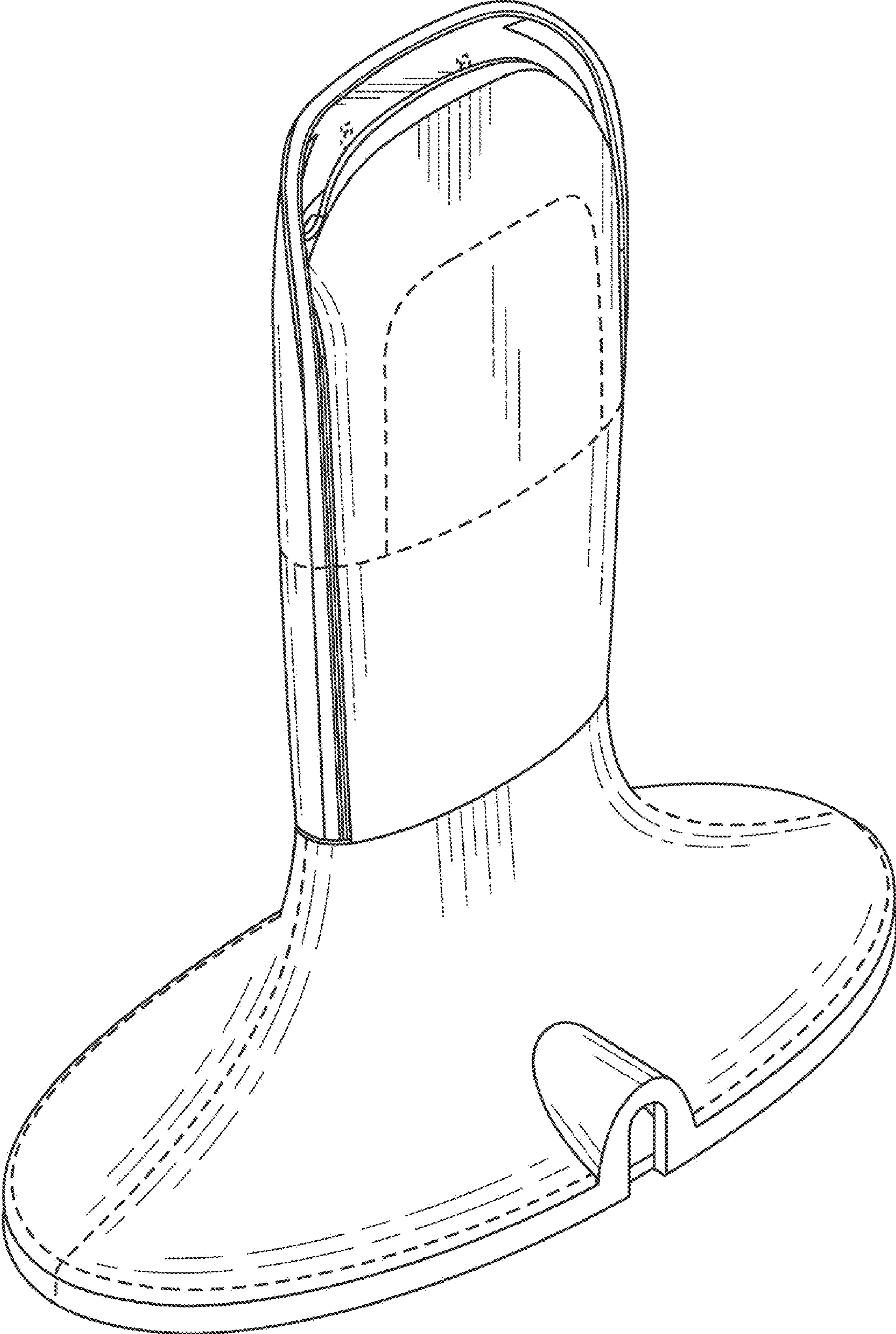

FIG. 13

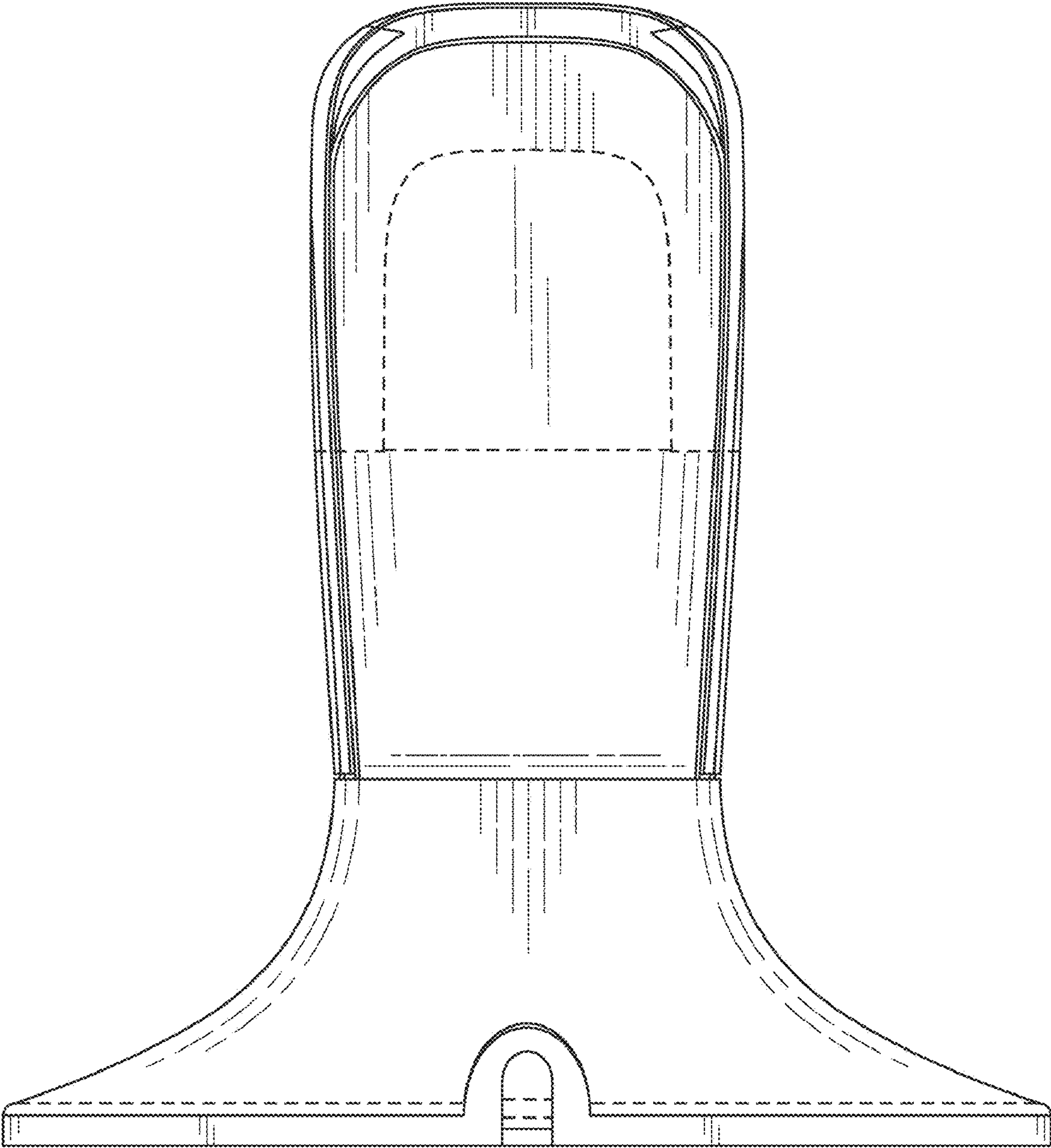

FIG. 14