



US00D628554S

(12) **United States Design Patent**
Tedja et al.

(10) **Patent No.:** **US D628,554 S**
(45) **Date of Patent:** **** Dec. 7, 2010**

(54) **HEADPHONE**

(75) Inventors: **Rudy Kurniawan Tedja**, Singapore (SG); **Nicholas Stephen Marchand**, Singapore (SG); **Zheng Guang Han**, Singapore (SG)

(73) Assignee: **Creative Technology Ltd**, Singapore (SG)

(**) Term: **14 Years**

(21) Appl. No.: **29/350,771**

(22) Filed: **Nov. 23, 2009**

(51) **LOC (9) Cl.** **14-01**

(52) **U.S. Cl.** **D14/205**

(58) **Field of Classification Search** D14/205,
D14/206, 223; D29/112, 122; 128/866,
128/867; 379/430, 431; 2/209; 381/380,
381/381, 383, 309, 370, 371, 374
See application file for complete search history.

(56) **References Cited**

U.S. PATENT DOCUMENTS

2,437,049	A *	3/1948	Salisbury et al.	128/866
3,579,640	A *	5/1971	Beguin et al.	2/209
D229,833	S *	1/1974	Becker	D14/205
4,459,707	A *	7/1984	Stallings	2/209
5,023,955	A *	6/1991	Murphy et al.	2/209
D328,074	S *	7/1992	Yamazaki et al.	D14/205
D337,115	S *	7/1993	Yamazaki et al.	D14/205
6,295,366	B1 *	9/2001	Haller et al.	381/374
D491,163	S *	6/2004	Green	D14/205

D541,255	S *	4/2007	Taylor et al.	D14/205
D552,077	S *	10/2007	Brunner et al.	D14/205
D563,382	S *	3/2008	Wikel	D14/205
D576,604	S *	9/2008	Suzuki	D14/205
D585,871	S *	2/2009	Lee	D14/205
D588,100	S *	3/2009	Densho et al.	D14/205
D594,847	S *	6/2009	Suzuki	D14/205
D597,070	S *	7/2009	Zheng	D14/205
D600,674	S *	9/2009	Brennwald	D14/205
D603,370	S *	11/2009	Suzuki	D14/205
D609,694	S *	2/2010	Komiyama	D14/205
D616,865	S *	6/2010	Marchand et al.	D14/205

* cited by examiner

Primary Examiner—Paula Greene

(57) **CLAIM**

The ornamental design for a headphone, substantially as shown and described.

DESCRIPTION

FIG. 1 is a left perspective view of a headphone showing our new design;

FIG. 2 is a right perspective view of the headphone in accordance with the present design;

FIG. 3 is front view of the headphone shown in FIG. 1;

FIG. 4 is back view of the headphone shown in FIG. 1;

FIG. 5 is a left view of the headphone shown in FIG. 1;

FIG. 6 is a right view of the headphone shown in FIG. 1;

FIG. 7 is a top view of the headphone shown in FIG. 1; and,

FIG. 8 is a bottom view of the headphone shown in FIG. 1.

1 Claim, 4 Drawing Sheets

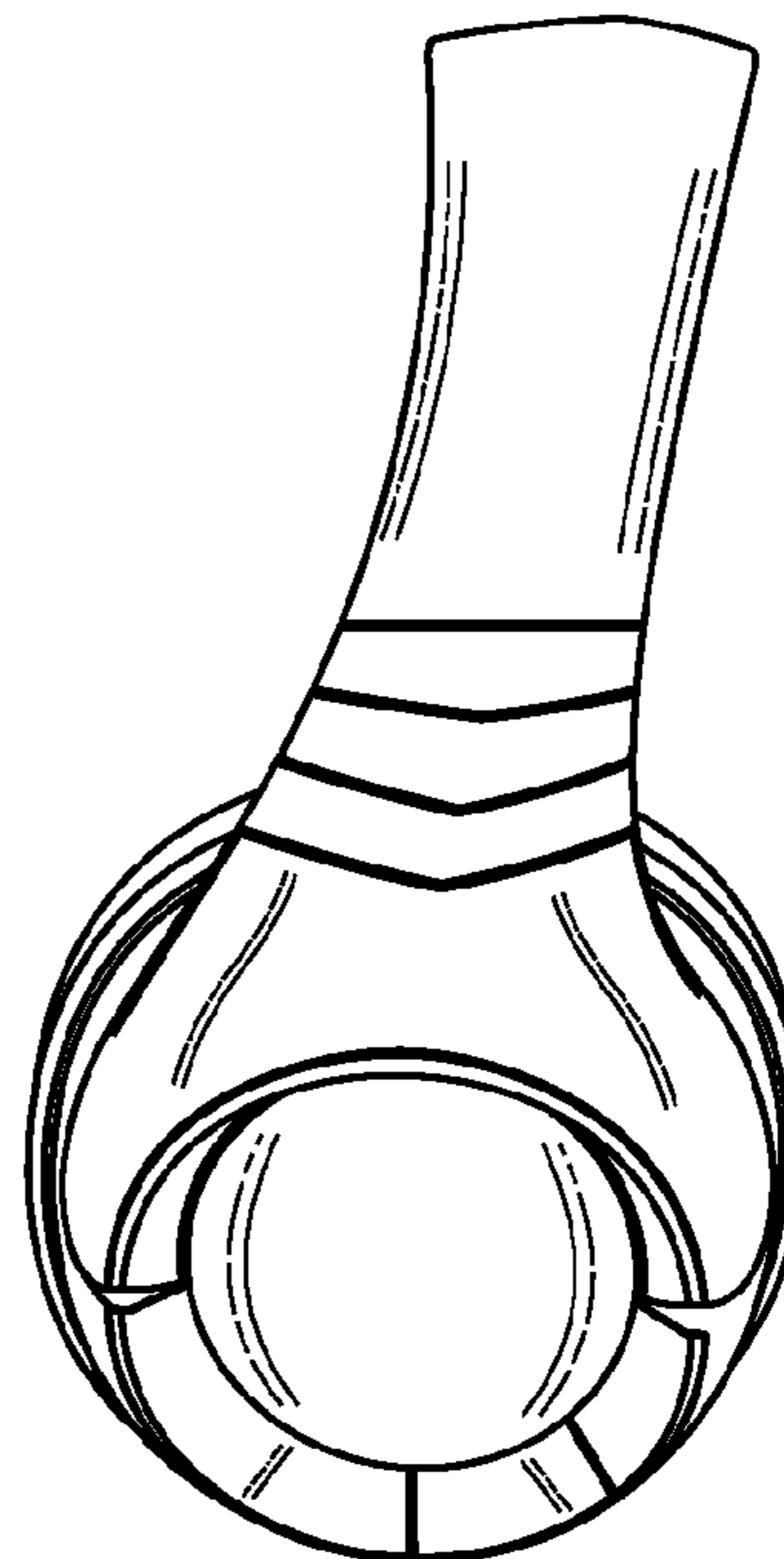
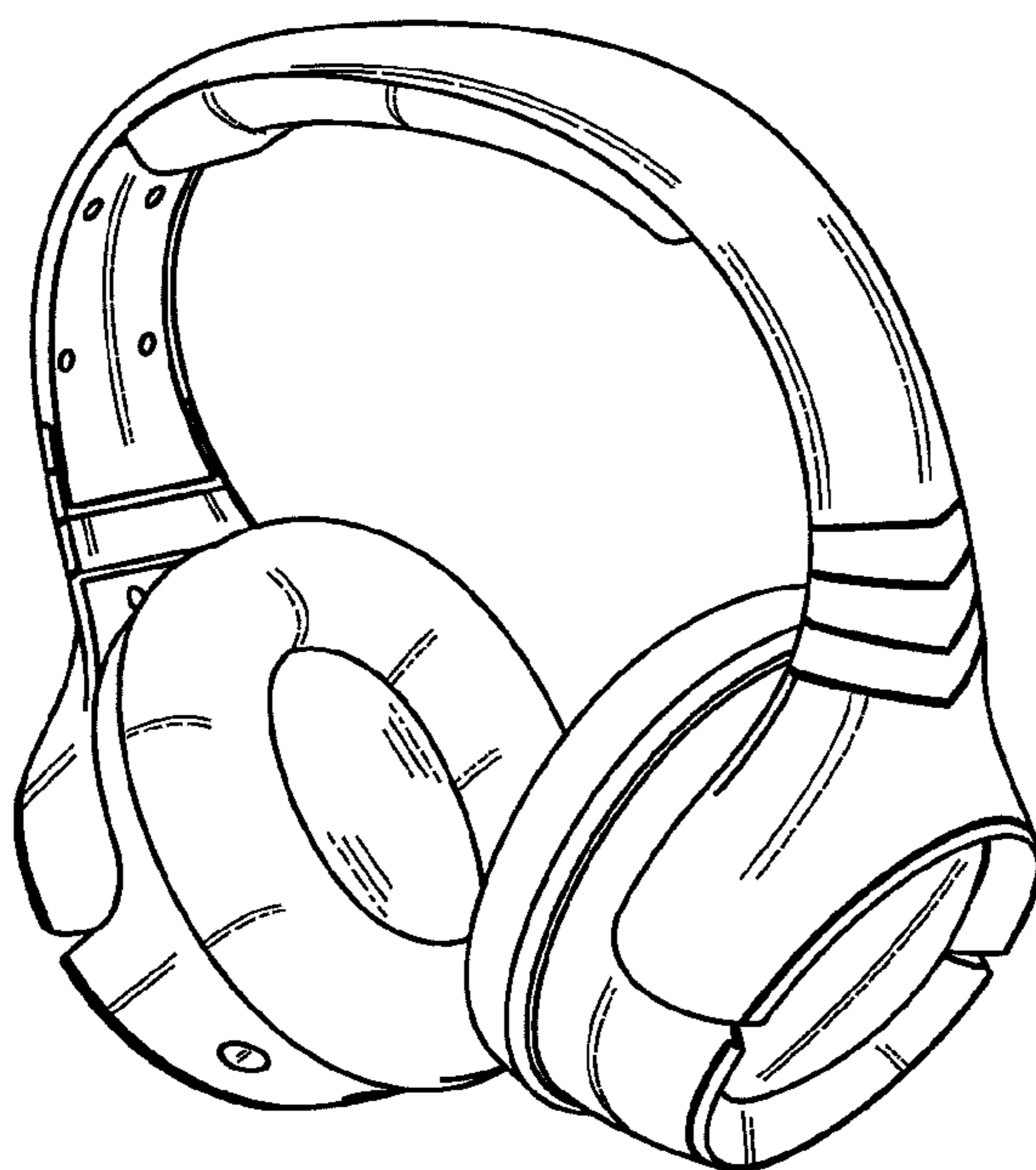

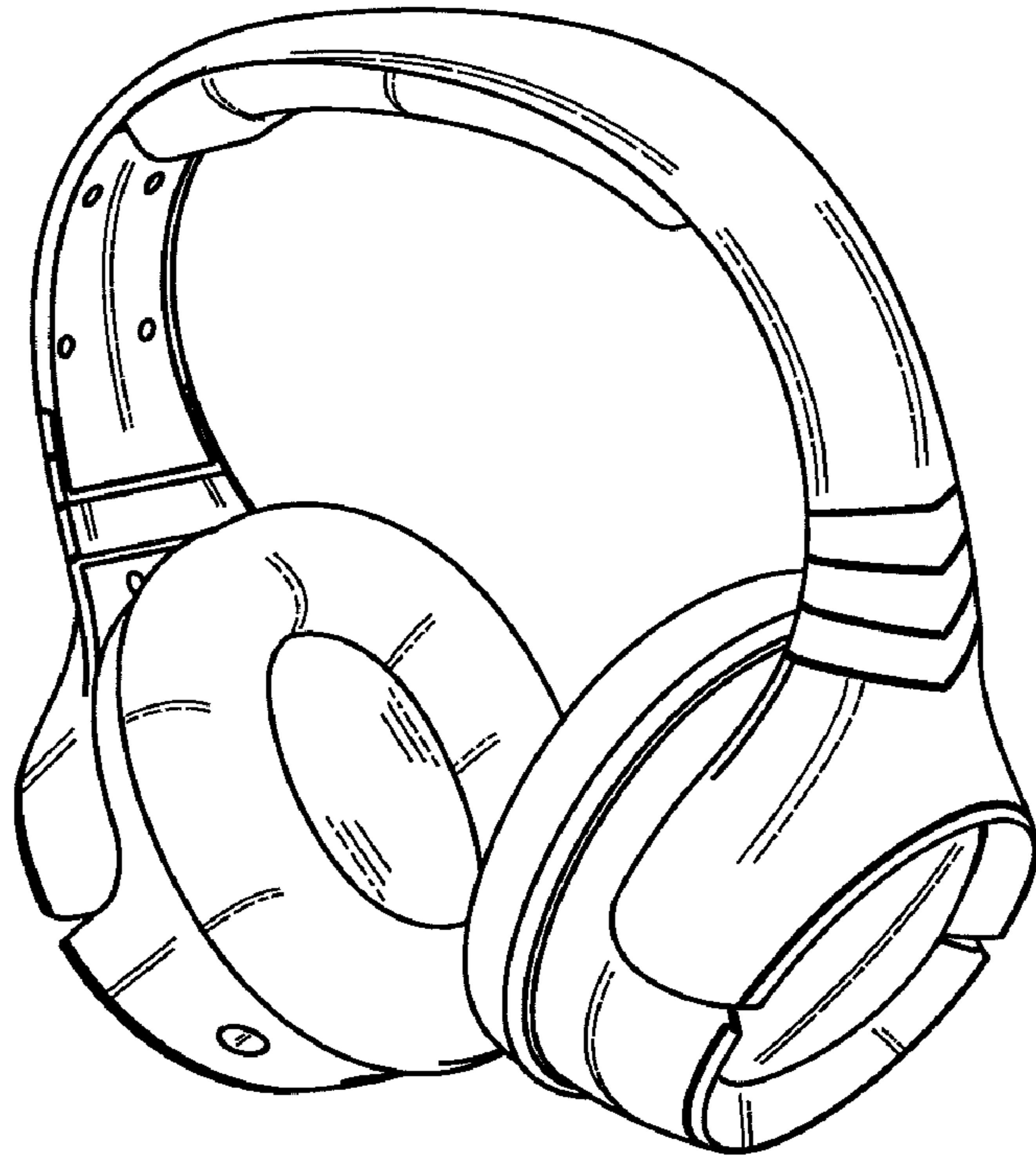

FIG. 1

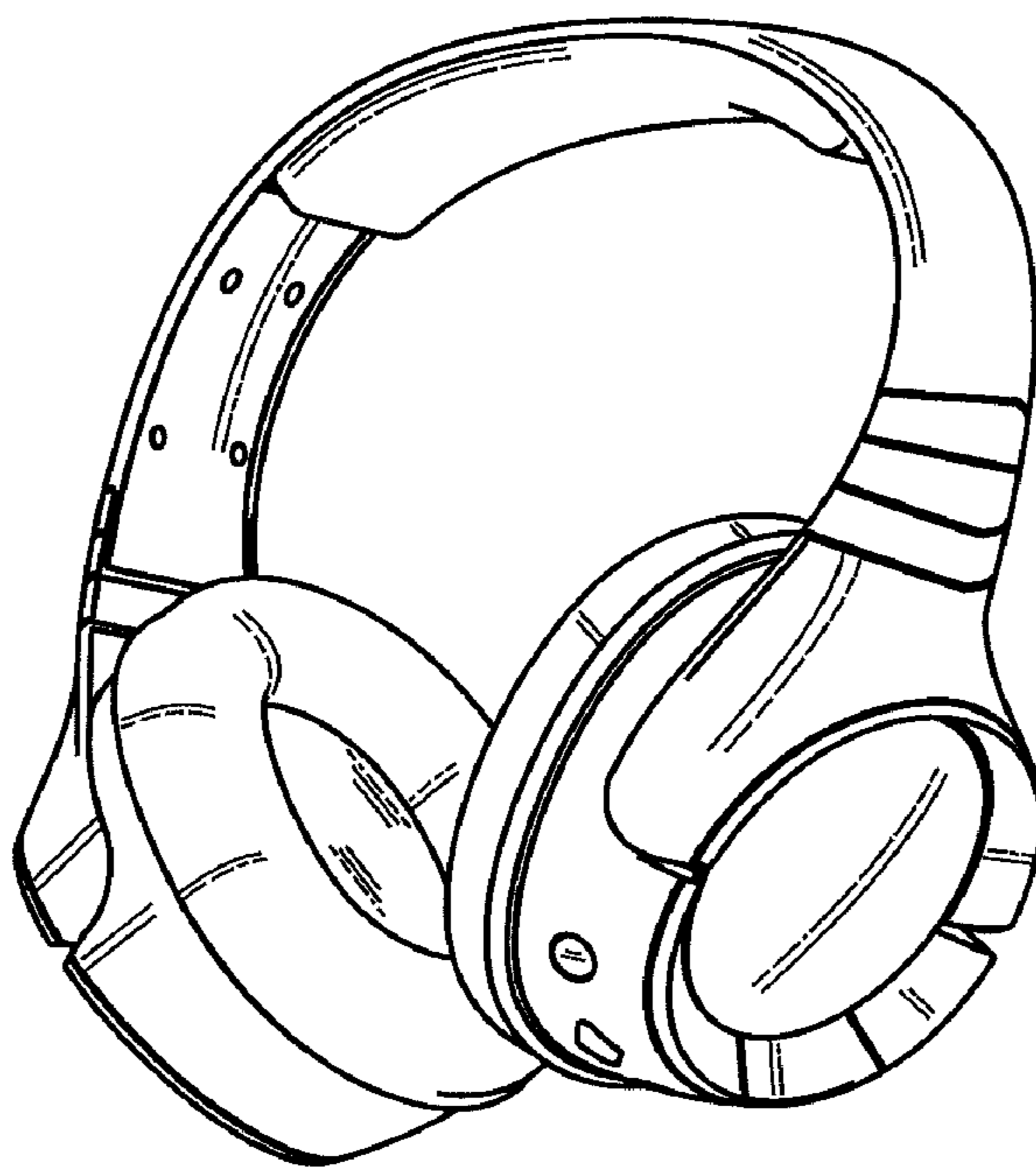

FIG. 2



FIG. 3



FIG. 4



FIG. 5

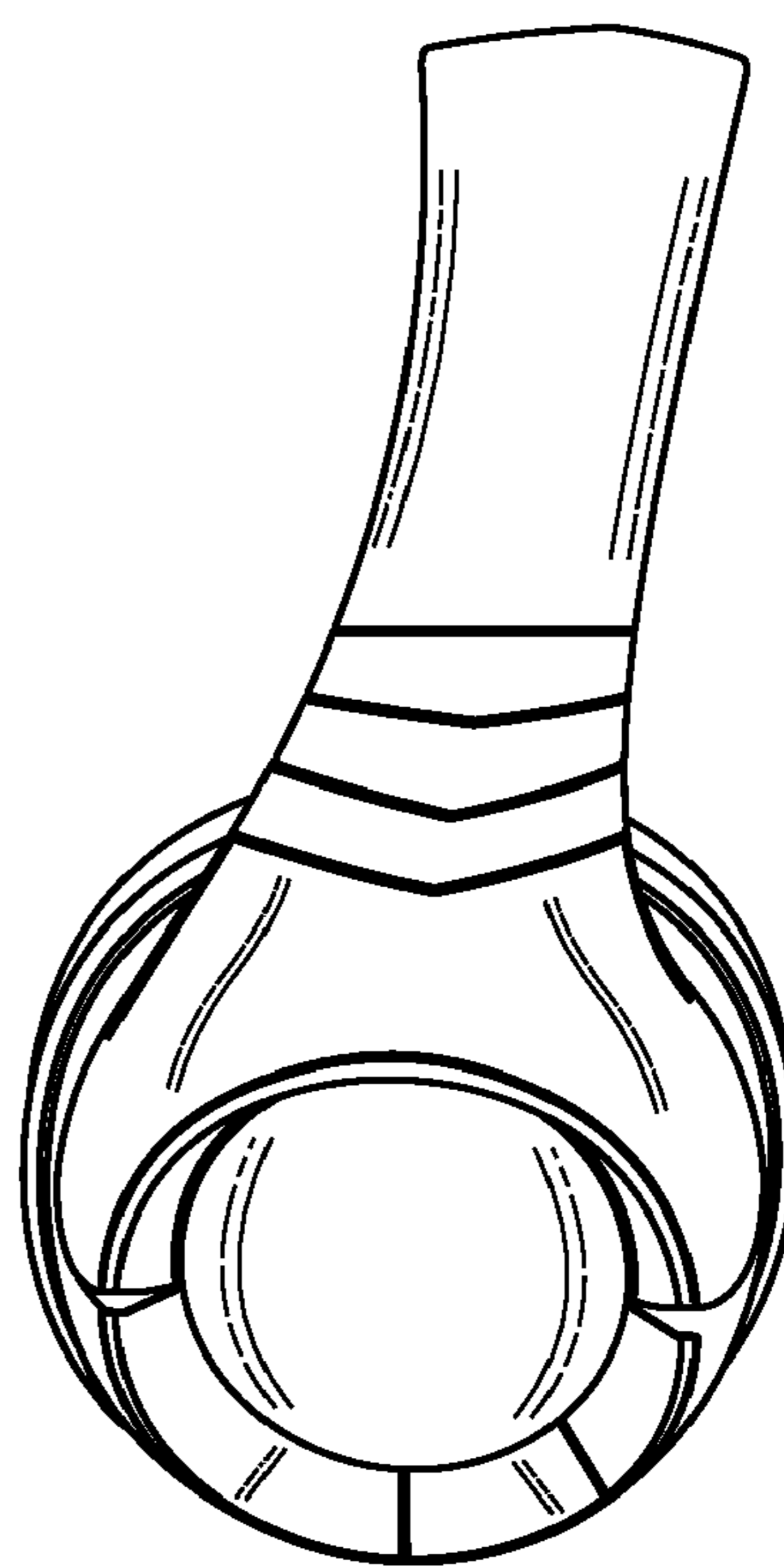

FIG. 6

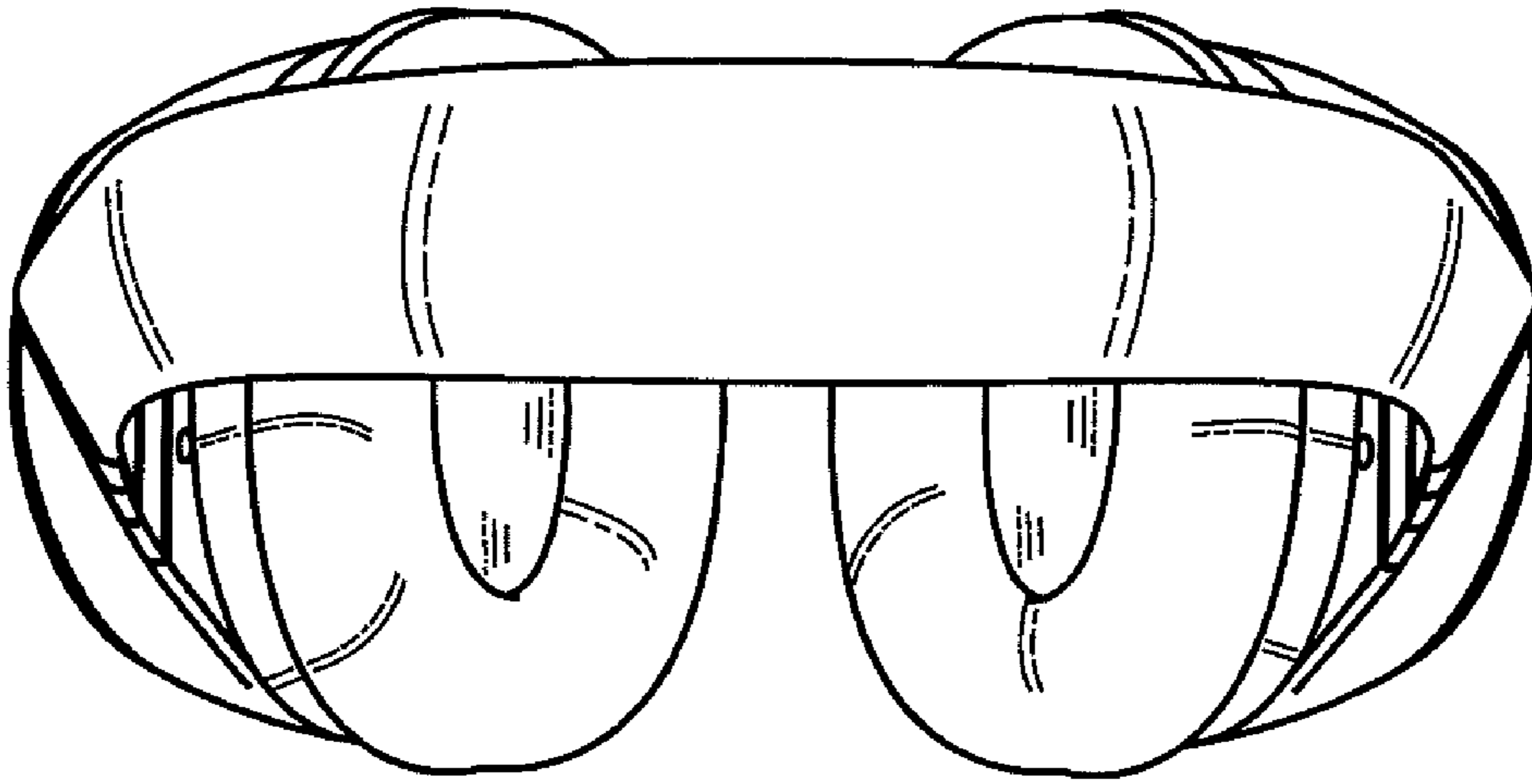

FIG. 7

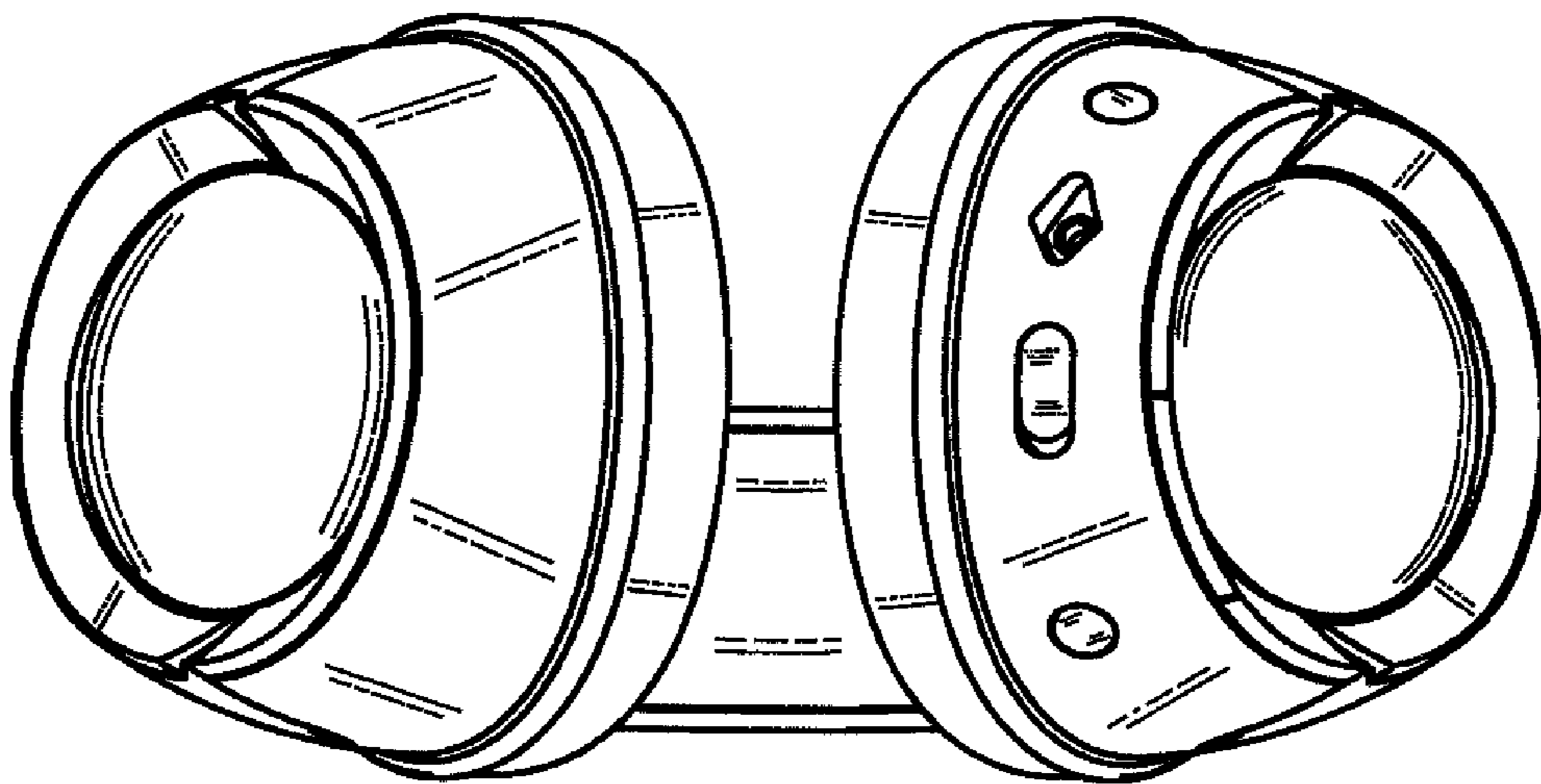

FIG. 8