

US00D628544S

(12) **United States Design Patent**  
**Hirose**

(10) **Patent No.:** **US D628,544 S**  
(45) **Date of Patent:** **\*\* Dec. 7, 2010**

(54) **DIGITAL AUDIO PLAYER**

(75) Inventor: **Masami Hirose**, Hachioji (JP)

(73) Assignee: **Clarion Co., Ltd.**, Tokyo (JP)

(\*\*) Term: **14 Years**

(21) Appl. No.: **29/329,065**

(22) Filed: **Dec. 8, 2008**

(51) **LOC (9) Cl.** ..... **14-03**

(52) **U.S. Cl.** ..... **D14/132**

(58) **Field of Classification Search** ..... D14/125-134,  
D14/239, 371, 136, 374-377, 440, 450, 448,  
D14/336, 342; 312/7.2; 348/836, 838, 180,  
348/184, 325, 739; 341/12; 248/917-924,  
248/465; 345/104, 133, 156, 168, 87, 173;  
720/605, 669, 600, 655; 369/99, 197; D21/329,  
D21/515, 577, 622, 333, 433, 448, 452, 450,  
D21/331; D6/477, 479, 300; 273/148 B;  
446/484, 175, 356; D10/15, 26

See application file for complete search history.

(56) **References Cited**

**U.S. PATENT DOCUMENTS**

D575,252 S \* 8/2008 Iwamoto ..... D14/132  
D578,974 S \* 10/2008 Miyawaki ..... D14/132  
D585,400 S \* 1/2009 Miyawaki ..... D14/132  
D590,363 S \* 4/2009 Yamamoto et al. .... D14/132

**FOREIGN PATENT DOCUMENTS**

JP S-D1075380 6/2000  
JP S-D1099489 2/2001  
JP S-D1116273 7/2001  
JP S-D-1160841 12/2002  
JP S-D1171428 4/2003  
JP S-D1173565 5/2003  
JP S-D1186049 9/2003  
JP S-D1186115 9/2003  
JP S-D1200871 4/2004  
JP S-D1210381 6/2004  
JP S-D1237673 4/2005  
JP S-D1244146 6/2005

JP S-D1280266 9/2006  
JP S-D1281560 9/2006  
JP S-D1290599 1/2007  
JP S-D1294852 2/2007  
JP S-D1306762 7/2007  
JP S-D1308198 8/2007  
JP S-D1309487 9/2007  
JP S-D1309488 9/2007

(Continued)

*Primary Examiner*—Raphael Barkai

(74) *Attorney, Agent, or Firm*—Oliff & Berridge, PLC

(57) **CLAIM**

The ornamental design for a digital audio player, as shown and described.

**DESCRIPTION**

FIG. 1 is a perspective view of a digital audio player in an open position;

FIG. 2 is a front view thereof;

FIG. 3 is a rear view thereof;

FIG. 4 is a left-side view thereof;

FIG. 5 is a right-side view thereof;

FIG. 6 is a top view thereof;

FIG. 7 is a bottom view thereof;

FIG. 8 is a perspective view of the digital audio player in a closed position;

FIG. 9 is a front view thereof;

FIG. 10 is a rear view thereof;

FIG. 11 is a side view thereof, the opposite side view being a mirror image;

FIG. 12 is a top view thereof; and,

FIG. 13 is a bottom view thereof.

The broken lines depict environmental subject matter only and form no part of the claimed design.

**1 Claim, 11 Drawing Sheets**

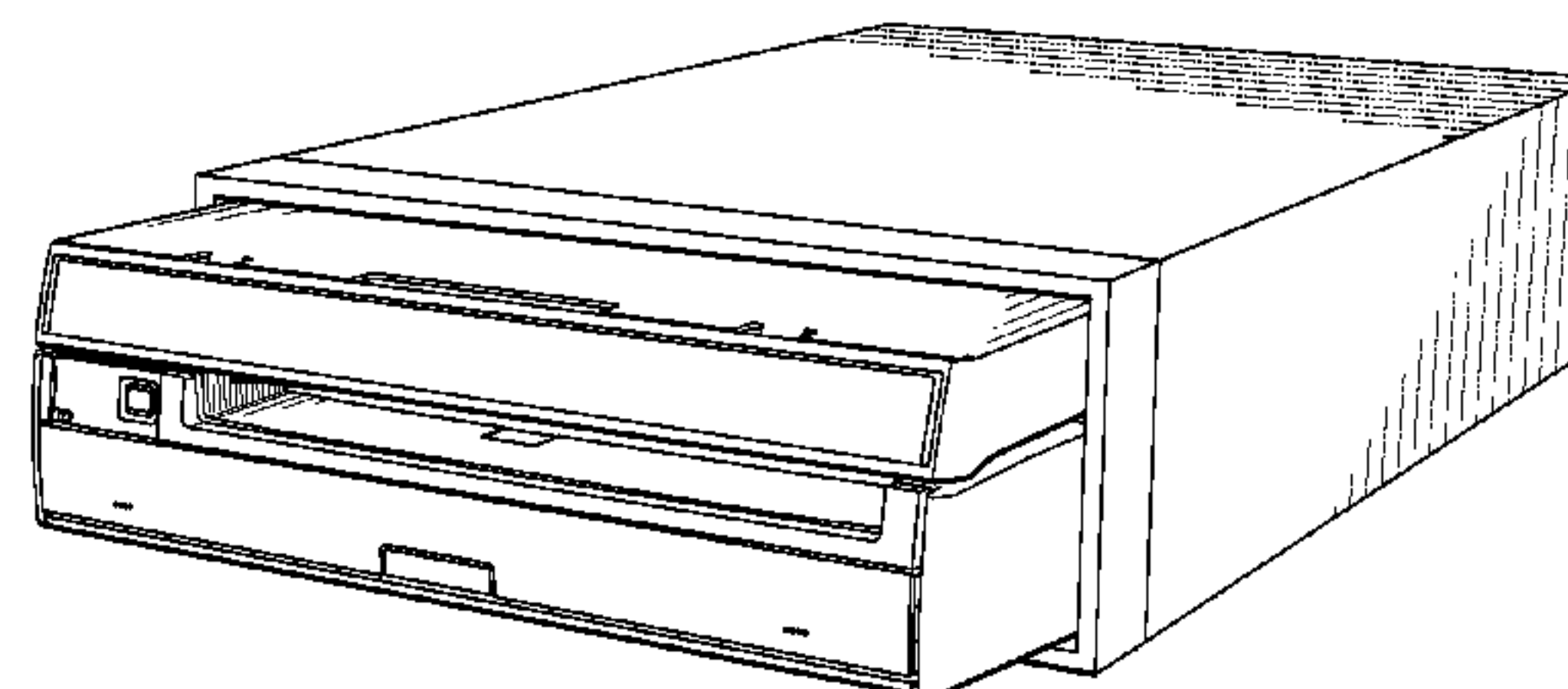
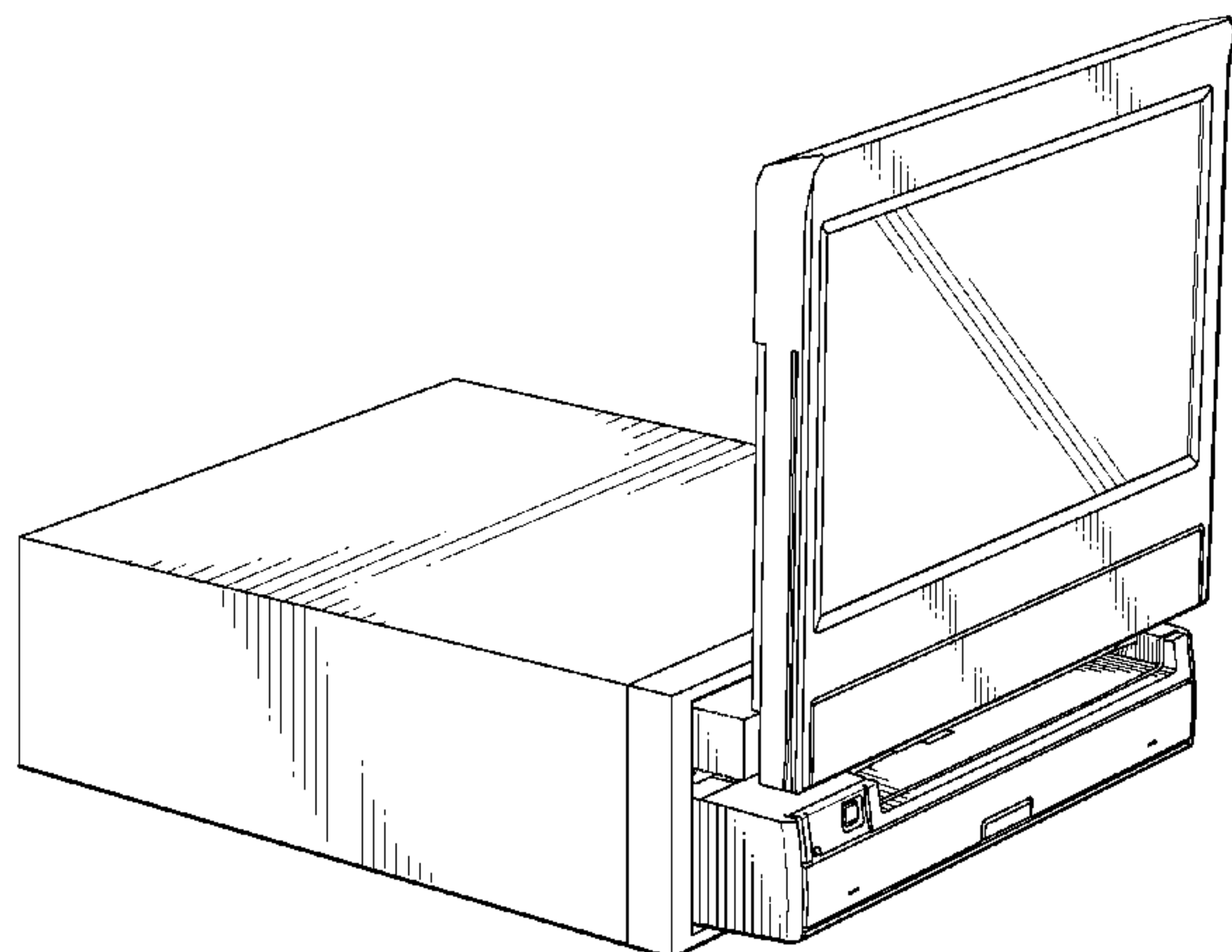

# US D628,544 S

Page 2

---

FOREIGN PATENT DOCUMENTS					
			JP	S-D1324646	3/2008
			JP	S-D1330854	5/2008
JP	S-D1309506	9/2007	JP	S-D1331330	5/2008
JP	S-D1324453	3/2008	JP	S-D1339186	9/2008
JP	S-D1324464	3/2008			
JP	S-D1324465	3/2008			

\* cited by examiner

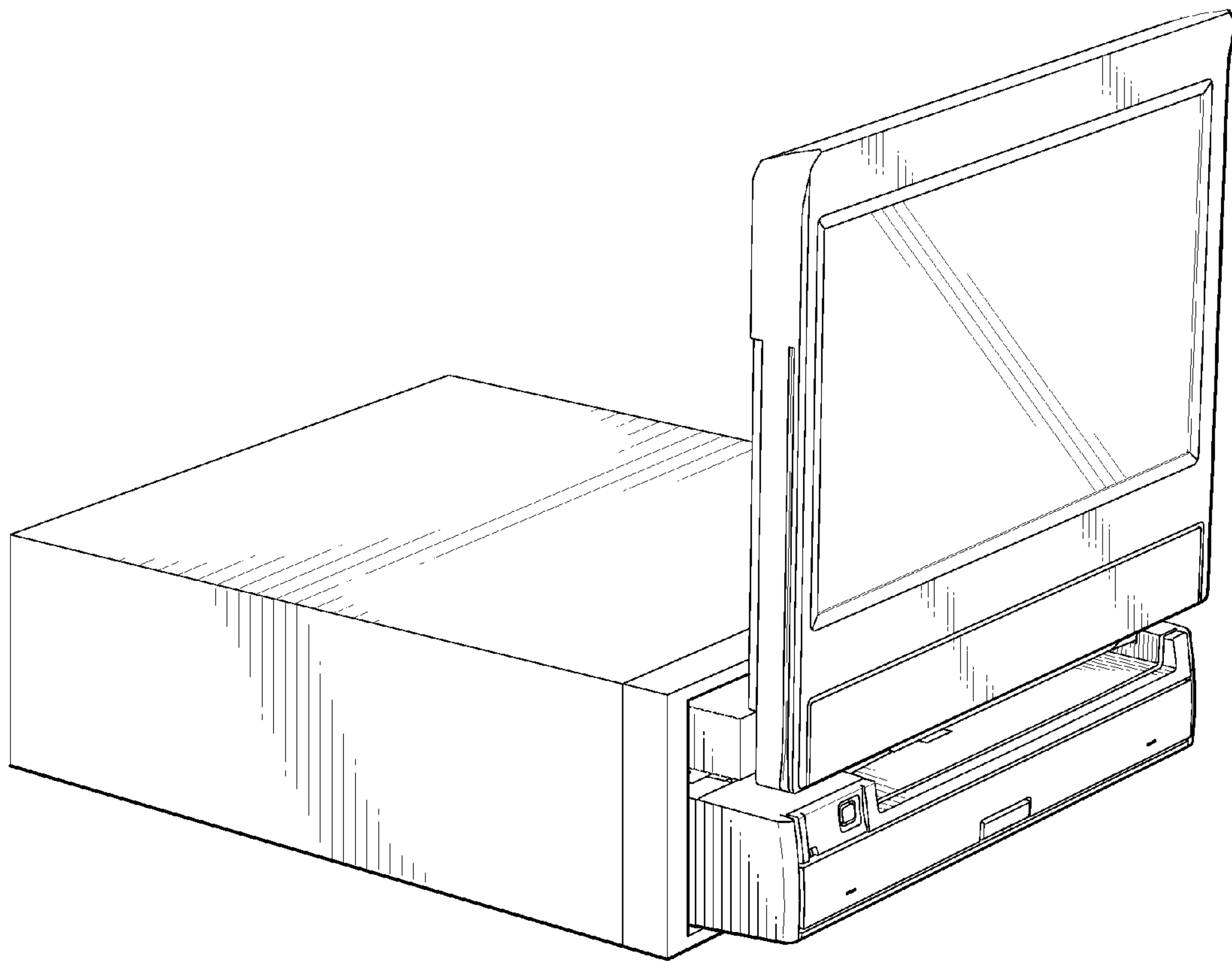

FIG. 1

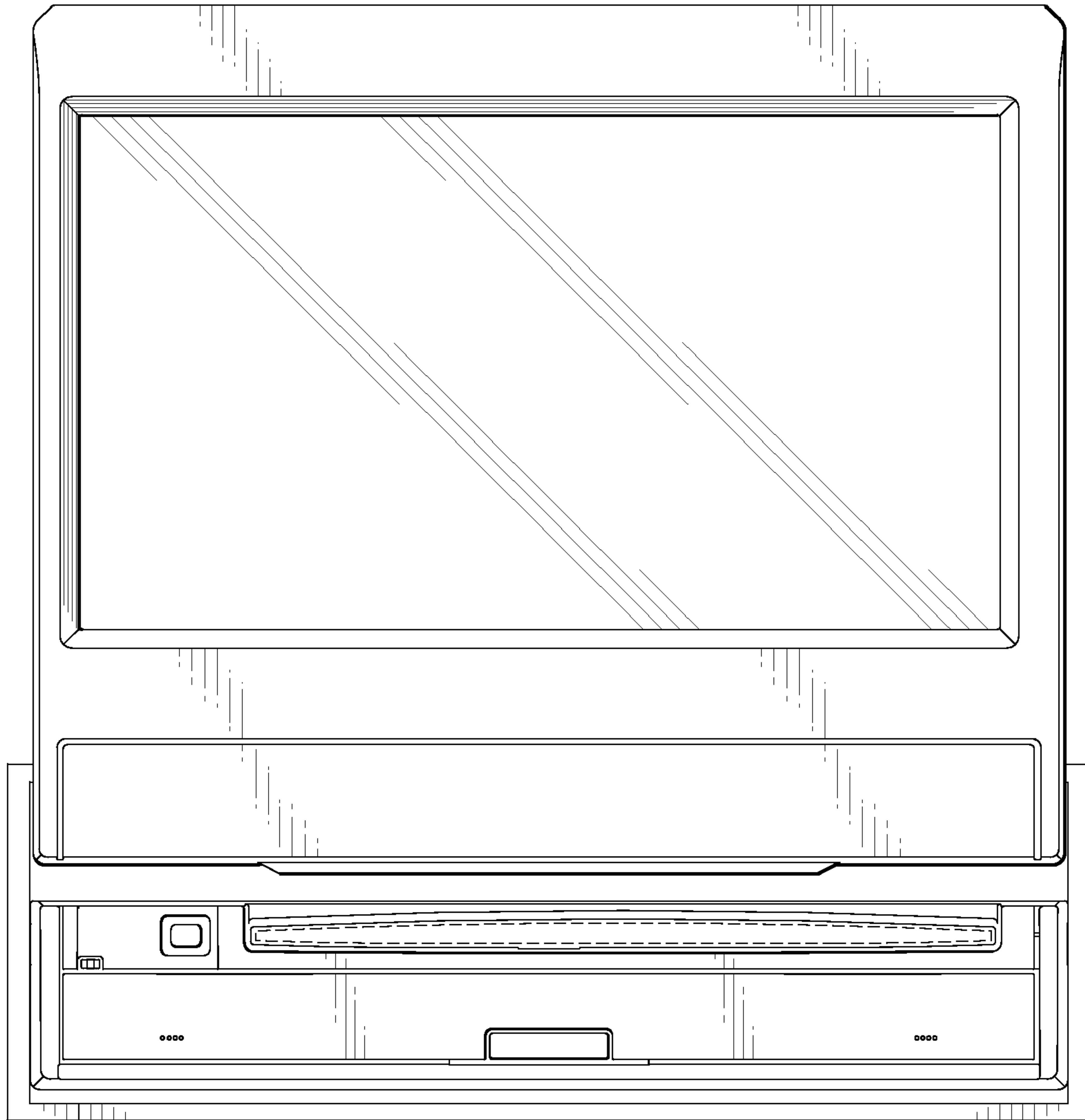

FIG. 2

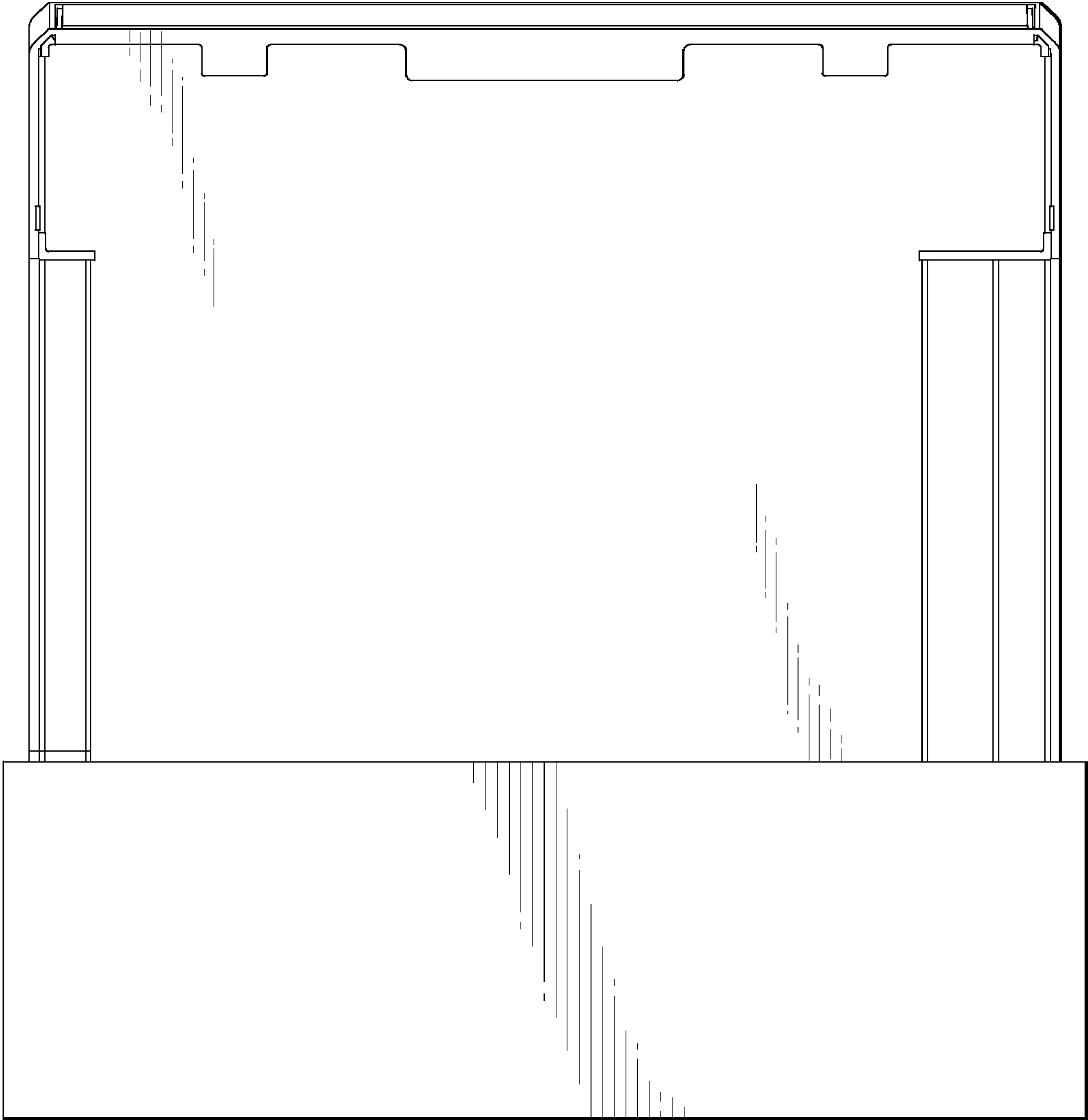

FIG. 3

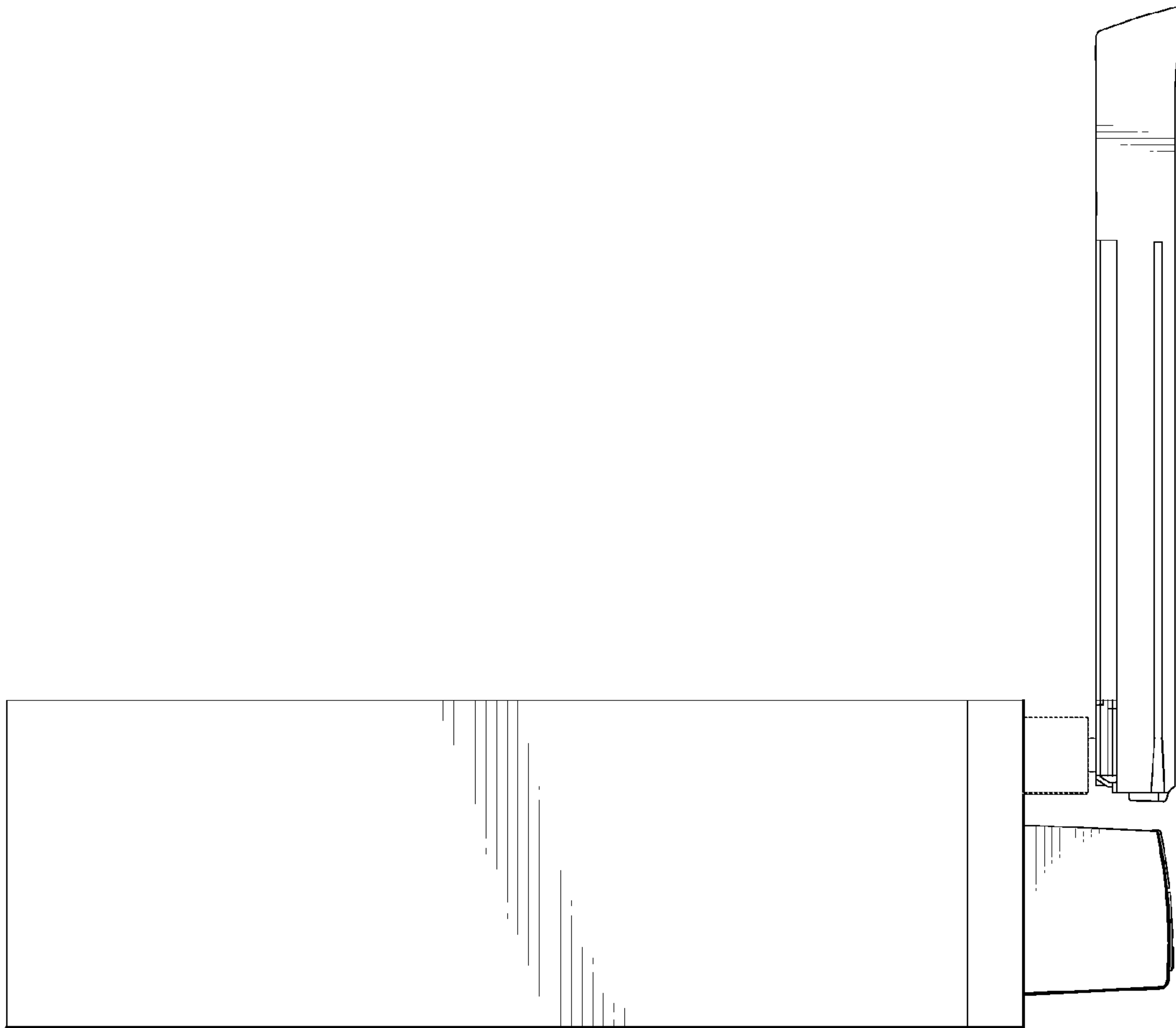

FIG. 4



FIG. 5

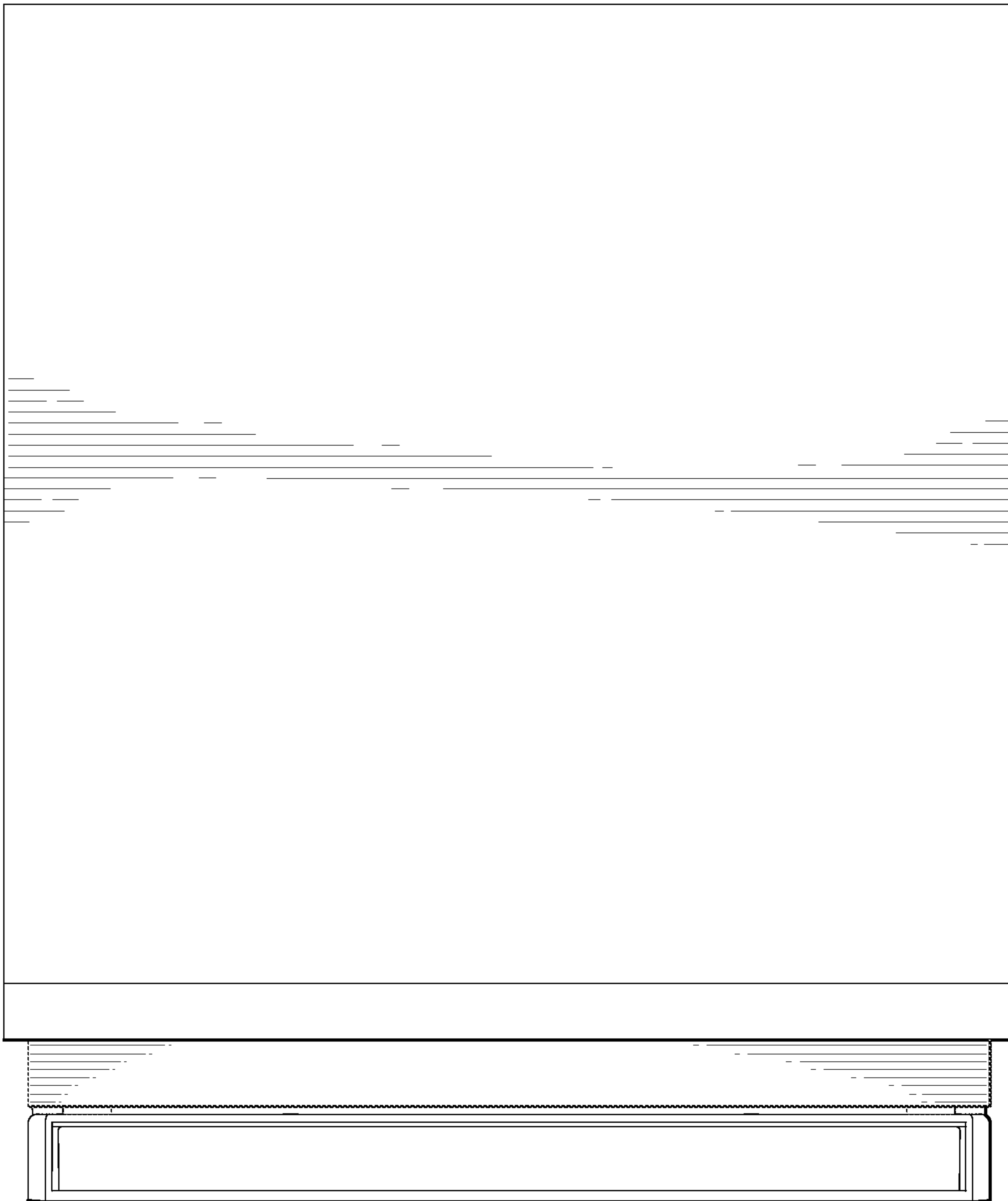

FIG. 6



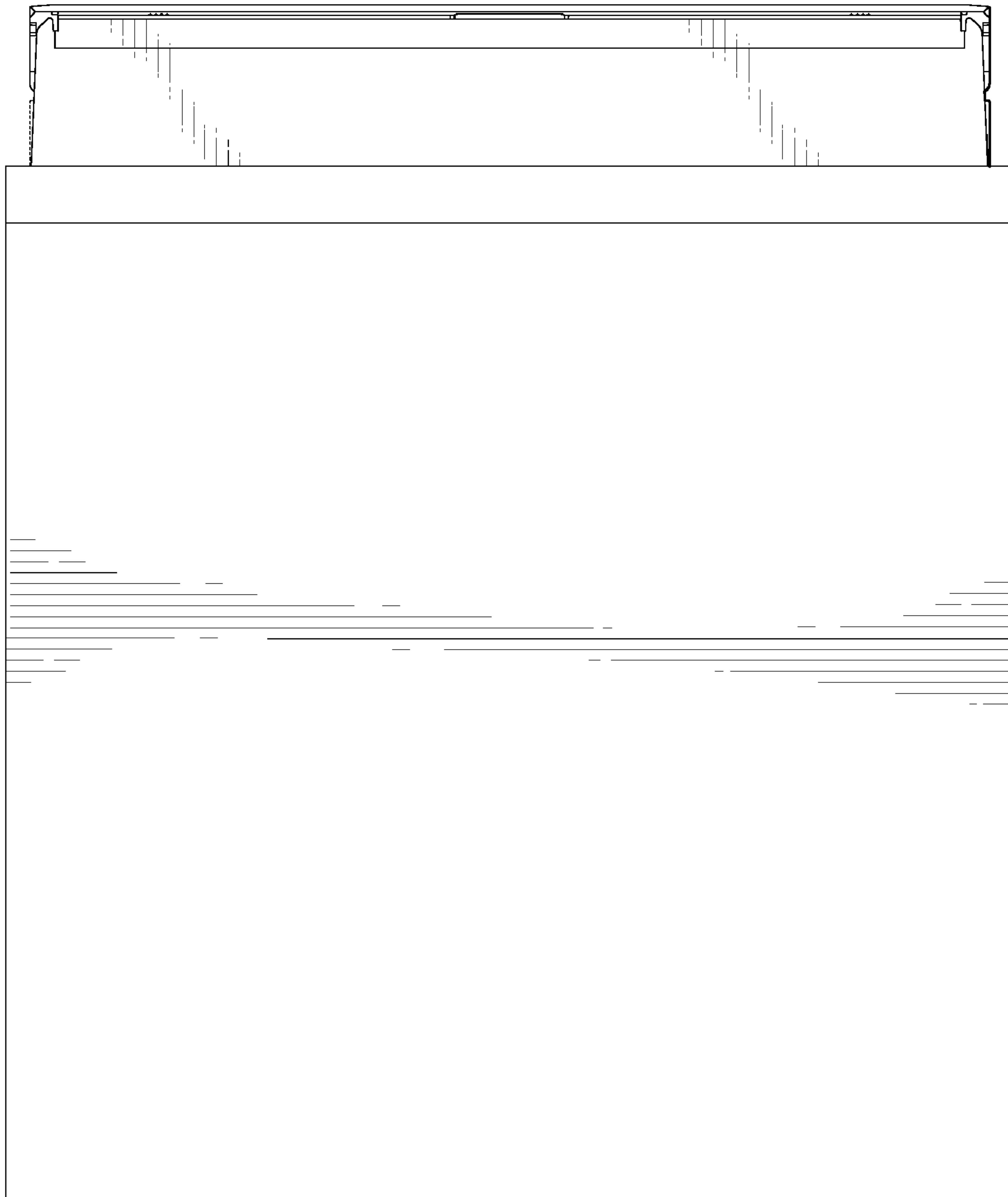

FIG. 7

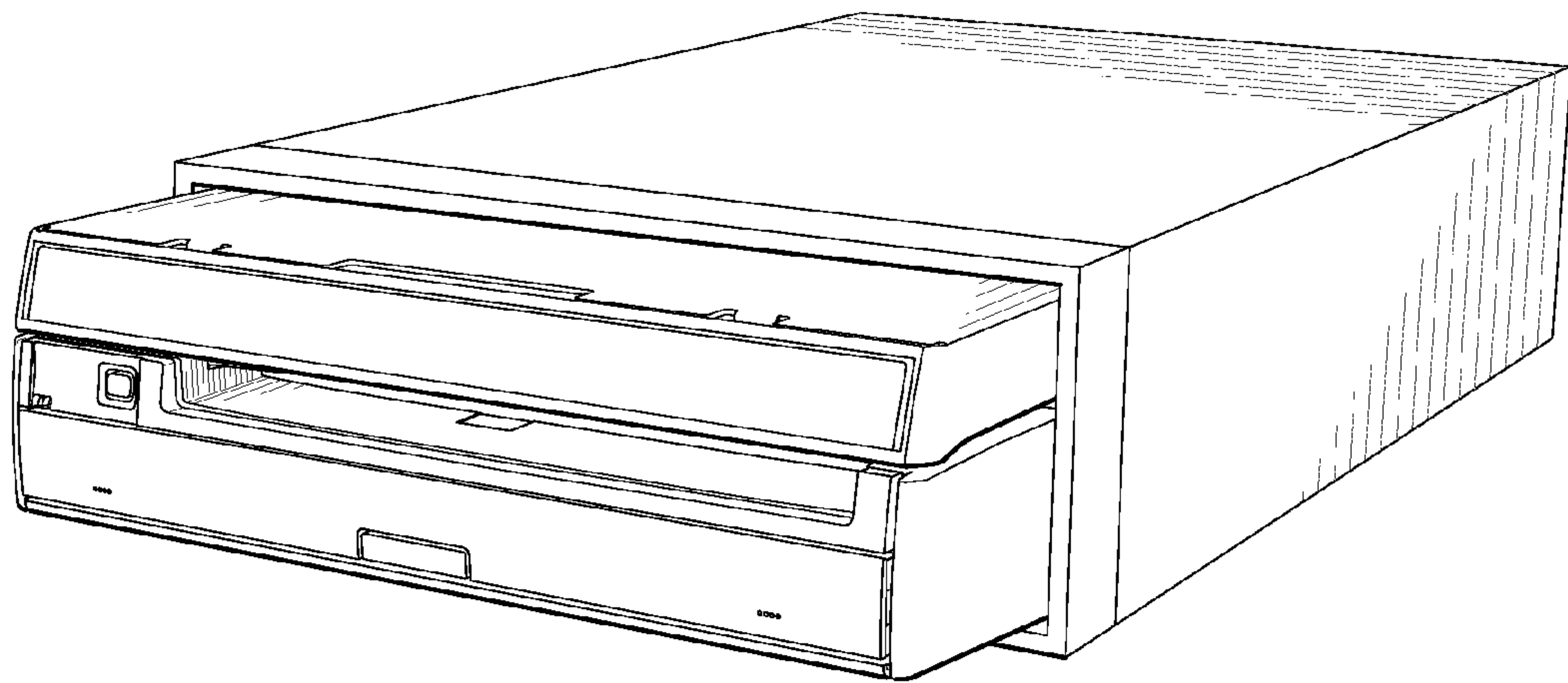

FIG. 8

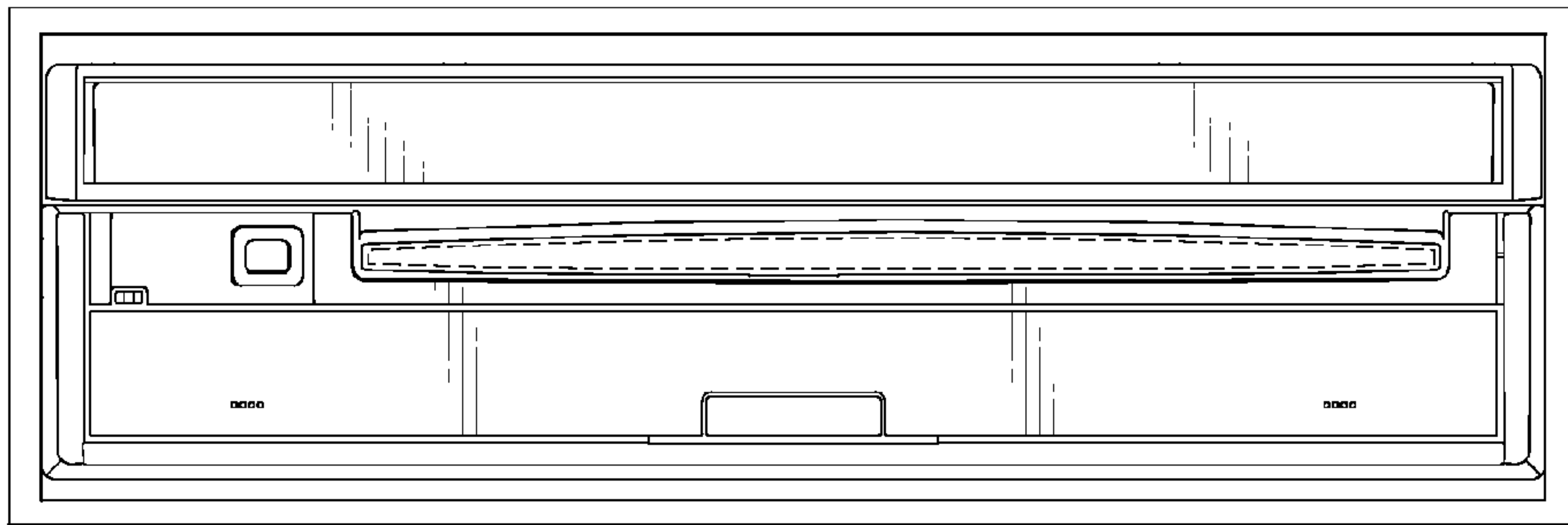

FIG. 9

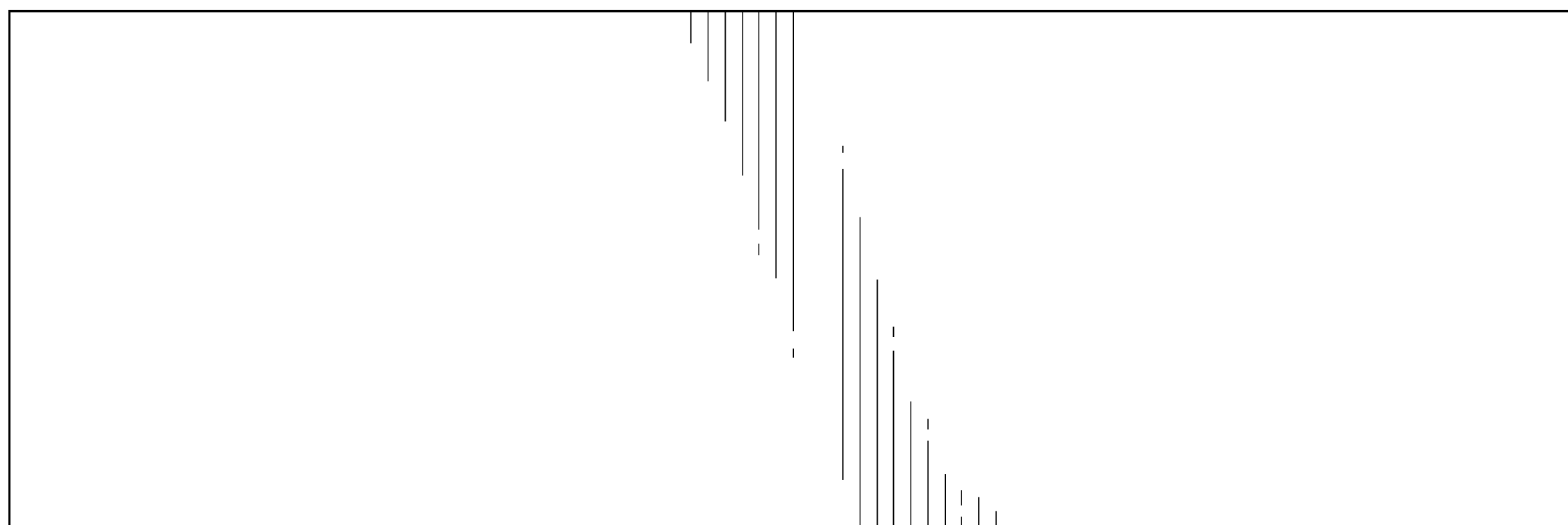

FIG. 10

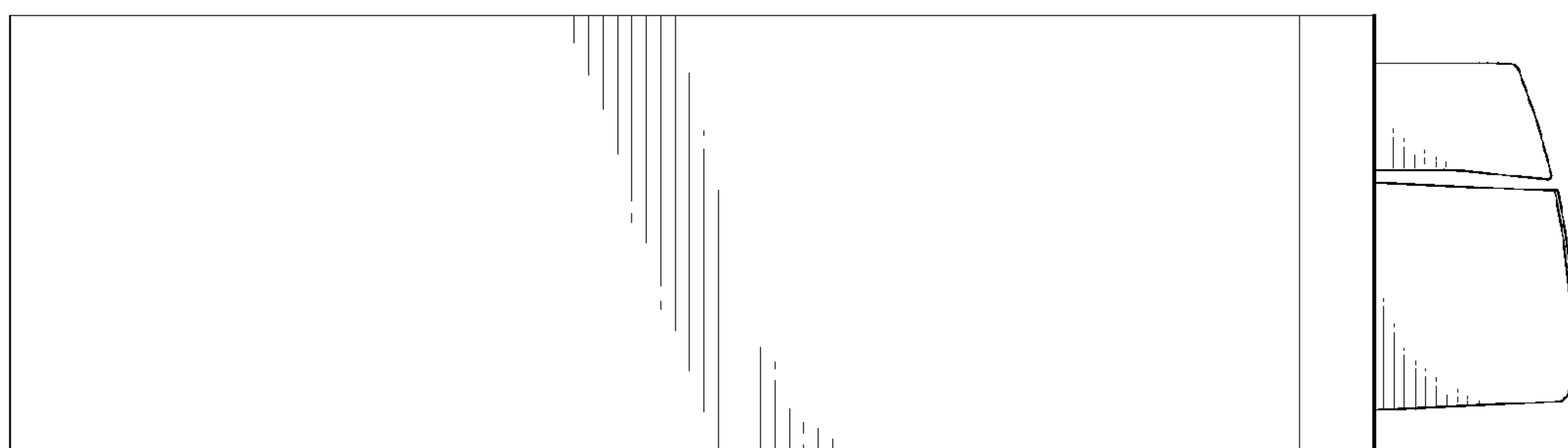

FIG. 11

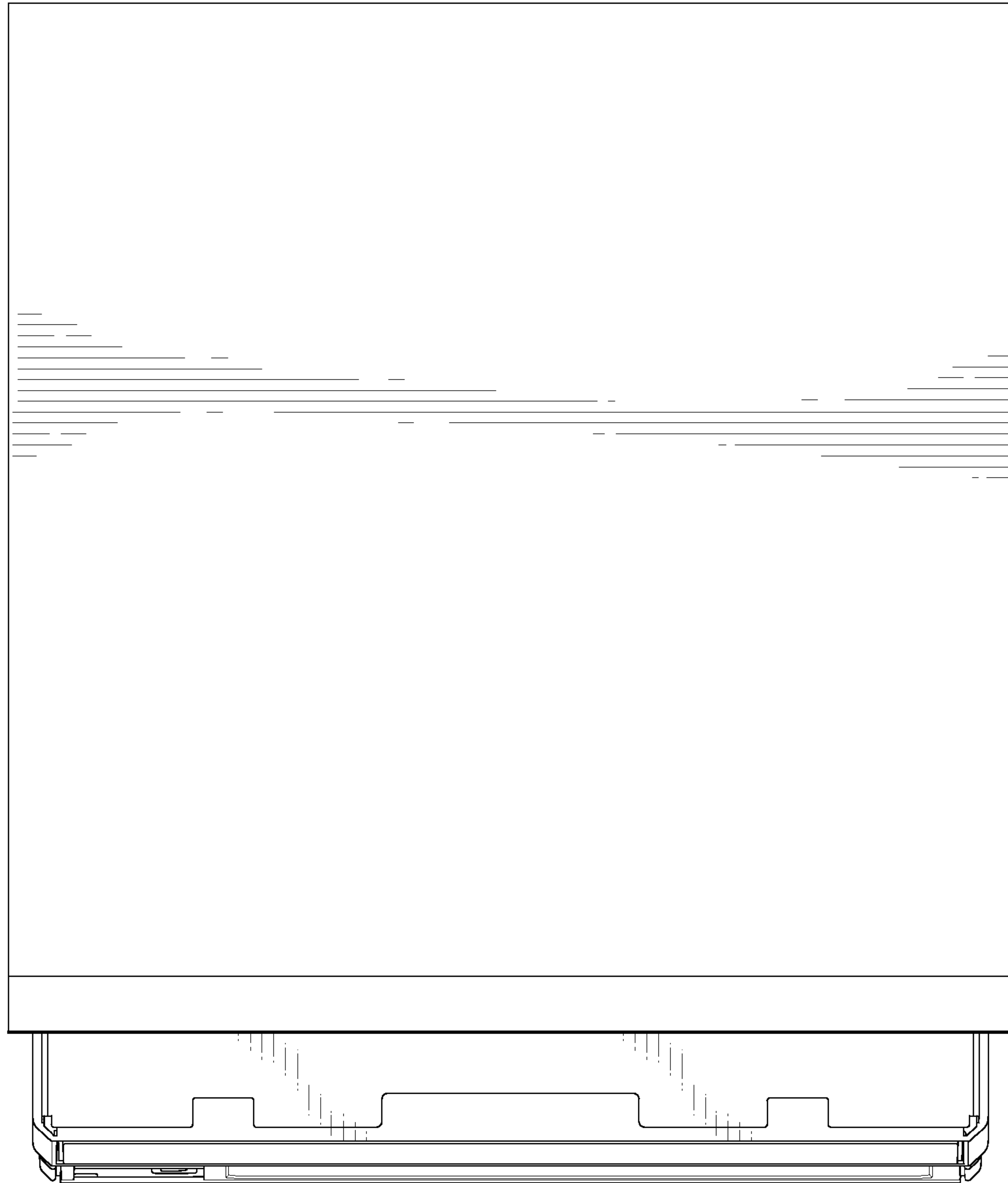

FIG. 12

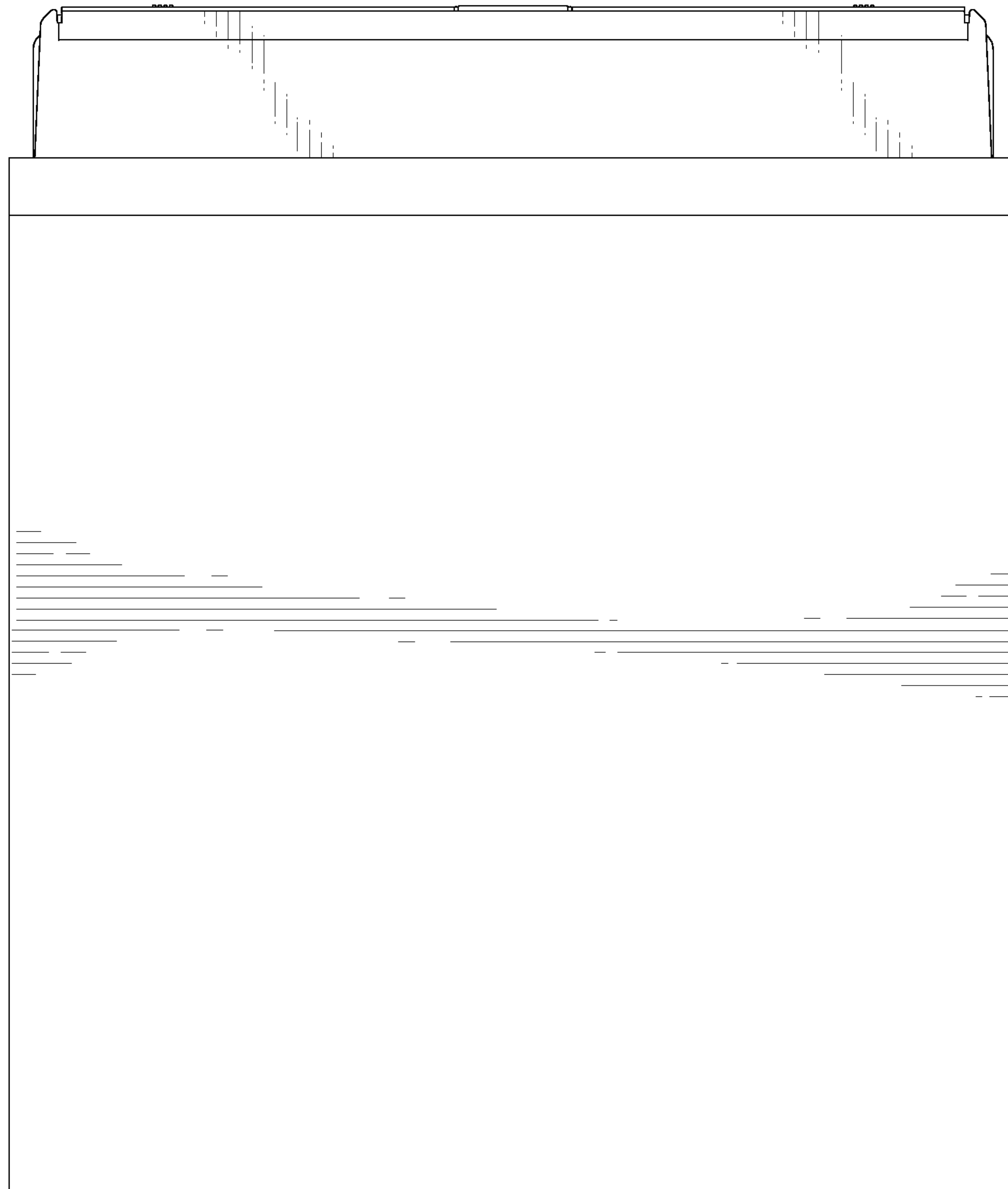

FIG. 13