



US00D628299S

(12) **United States Design Patent**  
**Held**

(10) **Patent No.:** **US D628,299 S**

(45) **Date of Patent:** **\*\* Nov. 30, 2010**

(54) **SHELF FOR A CEILING MOUNTED  
MEDICAL SUPPLY SYSTEM**

(75) Inventor: **Fred Held**, Hamburg (DE)

(73) Assignee: **Trumpf Medizia Systeme GmbH + Co.  
KG**, Puchheim (DE)

(\*\*) Term: **14 Years**

(21) Appl. No.: **29/361,218**

(22) Filed: **May 7, 2010**

(30) **Foreign Application Priority Data**

Mar. 8, 2010 (EM) ..... 1 202 220

(51) **LOC (9) Cl.** ..... **24-02**

(52) **U.S. Cl.** ..... **D24/185**

(58) **Field of Classification Search** ..... D24/183-186,  
D24/234, 128, 176-177, 227, 152, 232; D34/12-27;  
D6/436, 460, 431, 419-420, 480, 396; 280/47.18,  
280/47.26, 47.34, 47.35, 33.991, 33.992,  
280/33.993; 108/7; 211/70.6; 433/77

See application file for complete search history.

(56) **References Cited**

**U.S. PATENT DOCUMENTS**

D211,689 S *	7/1968	Edwards et al.	.....	D24/177
D243,188 S *	1/1977	Meyer	.....	D24/177
D288,122 S *	2/1987	McGaha et al.	.....	D24/177
D304,759 S *	11/1989	McCloskey	.....	D24/184
D313,276 S *	12/1990	McHugh	.....	D24/227
D323,560 S *	1/1992	Boyce et al.	.....	D24/183
D325,482 S *	4/1992	Schwartz	.....	D24/185
D328,791 S *	8/1992	Nordstrom et al.	.....	D24/177
D346,655 S *	5/1994	Harris	.....	D24/128
D354,136 S *	1/1995	Phelps et al.	.....	D24/177
D354,350 S *	1/1995	Pryor et al.	.....	D24/128
D361,620 S *	8/1995	Phleps et al.	.....	D24/177
5,454,797 A *	10/1995	Haswell	.....	604/317
D378,416 S *	3/1997	LaPlante et al.	.....	D24/177

D380,549 S *	7/1997	Pate	.....	D24/152
D458,379 S *	6/2002	Brockway et al.	.....	D24/177
D493,229 S *	7/2004	Coburn et al.	.....	D24/176
D494,280 S *	8/2004	Schmidt et al.	.....	D24/232
D498,847 S *	11/2004	Castellini	.....	D24/177
D544,962 S *	6/2007	Diener et al.	.....	D24/186
D548,918 S *	8/2007	Nussberger et al.	.....	D34/17
D553,324 S *	10/2007	Lieblein et al.	.....	D34/14
D555,247 S *	11/2007	Castellini	.....	D24/177
D572,424 S *	7/2008	Presnell et al.	.....	D34/27
7,490,837 B2 *	2/2009	Pond et al.	.....	433/77
D596,420 S *	7/2009	Yoshida	.....	D6/396
D606,202 S *	12/2009	Banryu	.....	D24/185
D607,566 S *	1/2010	Bukoski	.....	D24/177
D607,567 S *	1/2010	Bukoski	.....	D24/184
D609,349 S *	2/2010	Pelissier et al.	.....	D24/186
D612,561 S *	3/2010	Hunter et al.	.....	D34/14
D613,867 S *	4/2010	Tanaka et al.	.....	D24/185

\* cited by examiner

*Primary Examiner*—T. Chase Nelson

*Assistant Examiner*—Mark Cavanna

(74) *Attorney, Agent, or Firm*—Fish & Richardson P.C.

(57) **CLAIM**

The ornamental design for a shelf for a ceiling mounted medical supply system, substantially as shown and described.

**DESCRIPTION**

FIG. 1 shows a perspective view of the design;

FIG. 2 shows a front view of the design;

FIG. 3 shows a rear view of the design;

FIG. 4 shows a right side view of the design;

FIG. 5 shows a left side view of the design;

FIG. 6 shows a top plan view of the design; and,

FIG. 7 shows a bottom plan view of the design.

The features shown in broken lines are environmental structure and form no part of the claimed design.

**1 Claim, 4 Drawing Sheets**

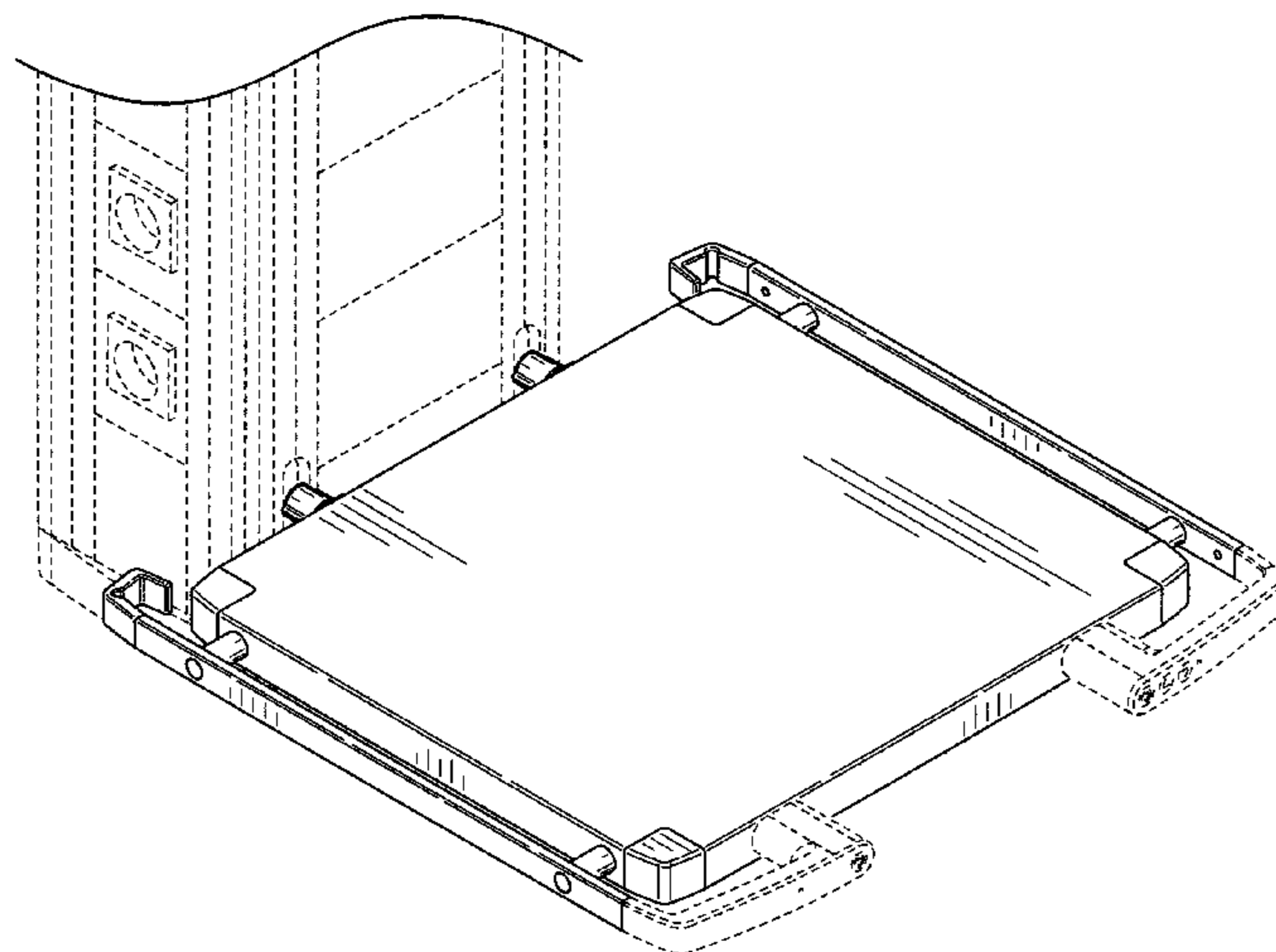

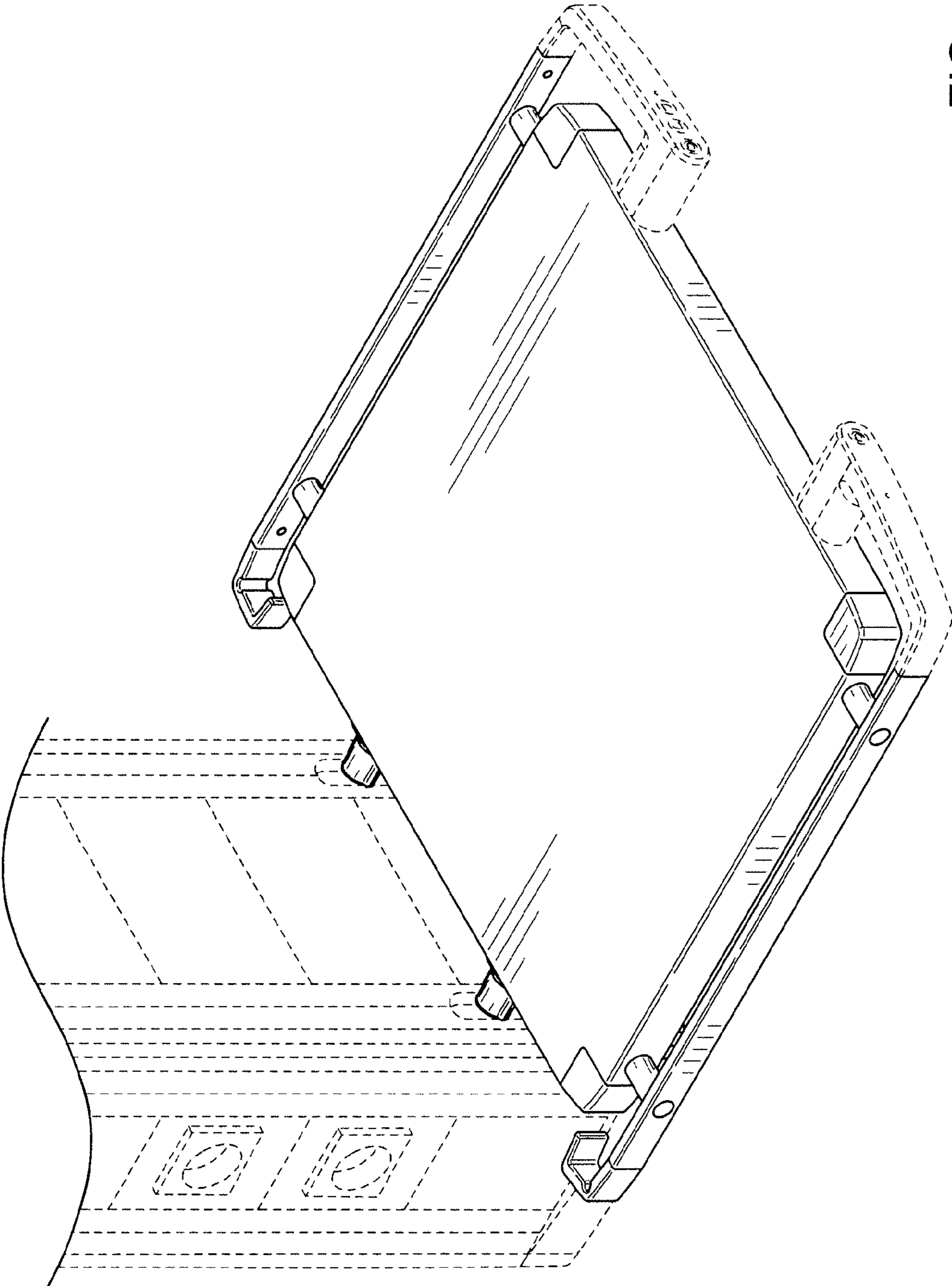

FIG. 1



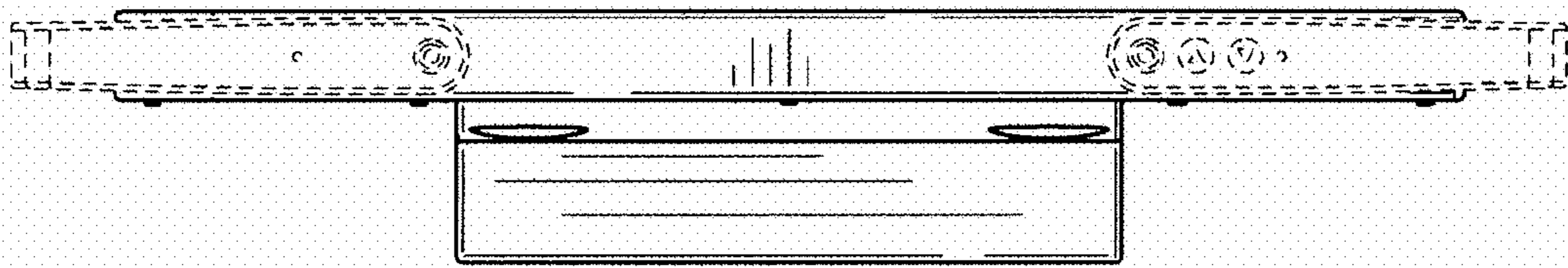

FIG. 2

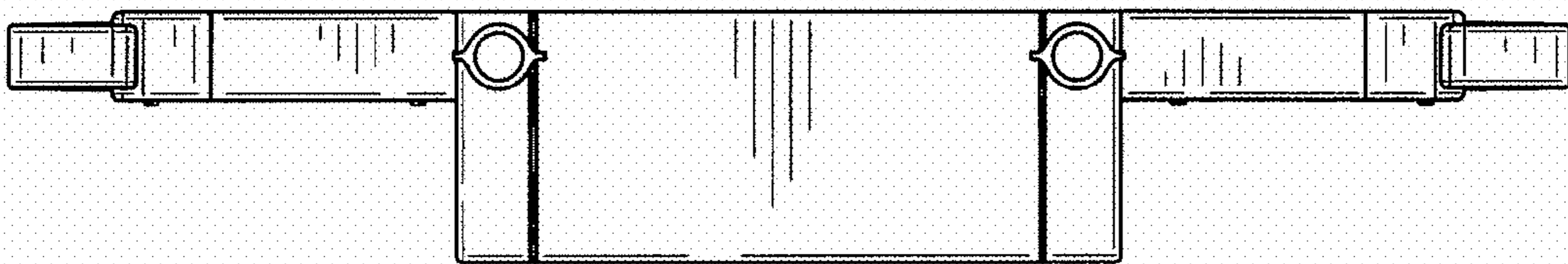

FIG. 3

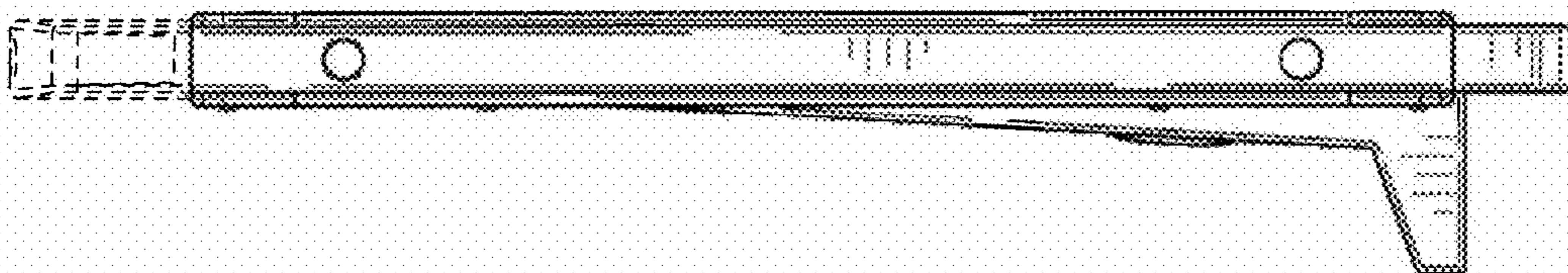

FIG. 4

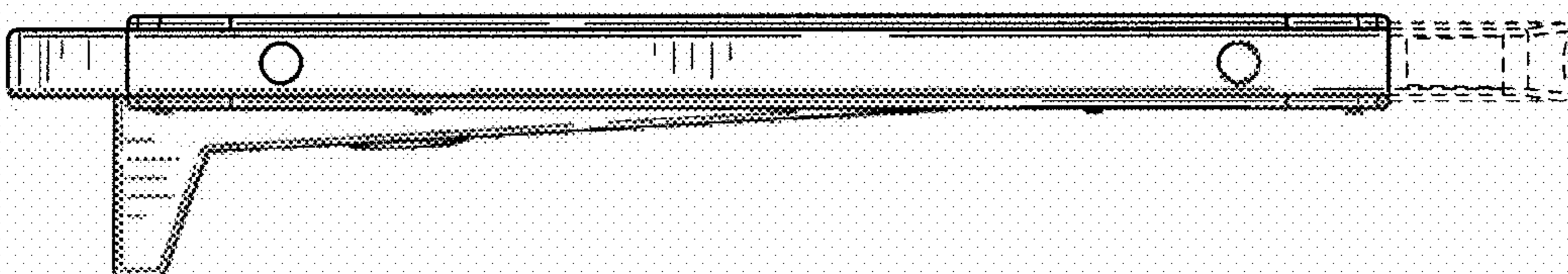

FIG. 5

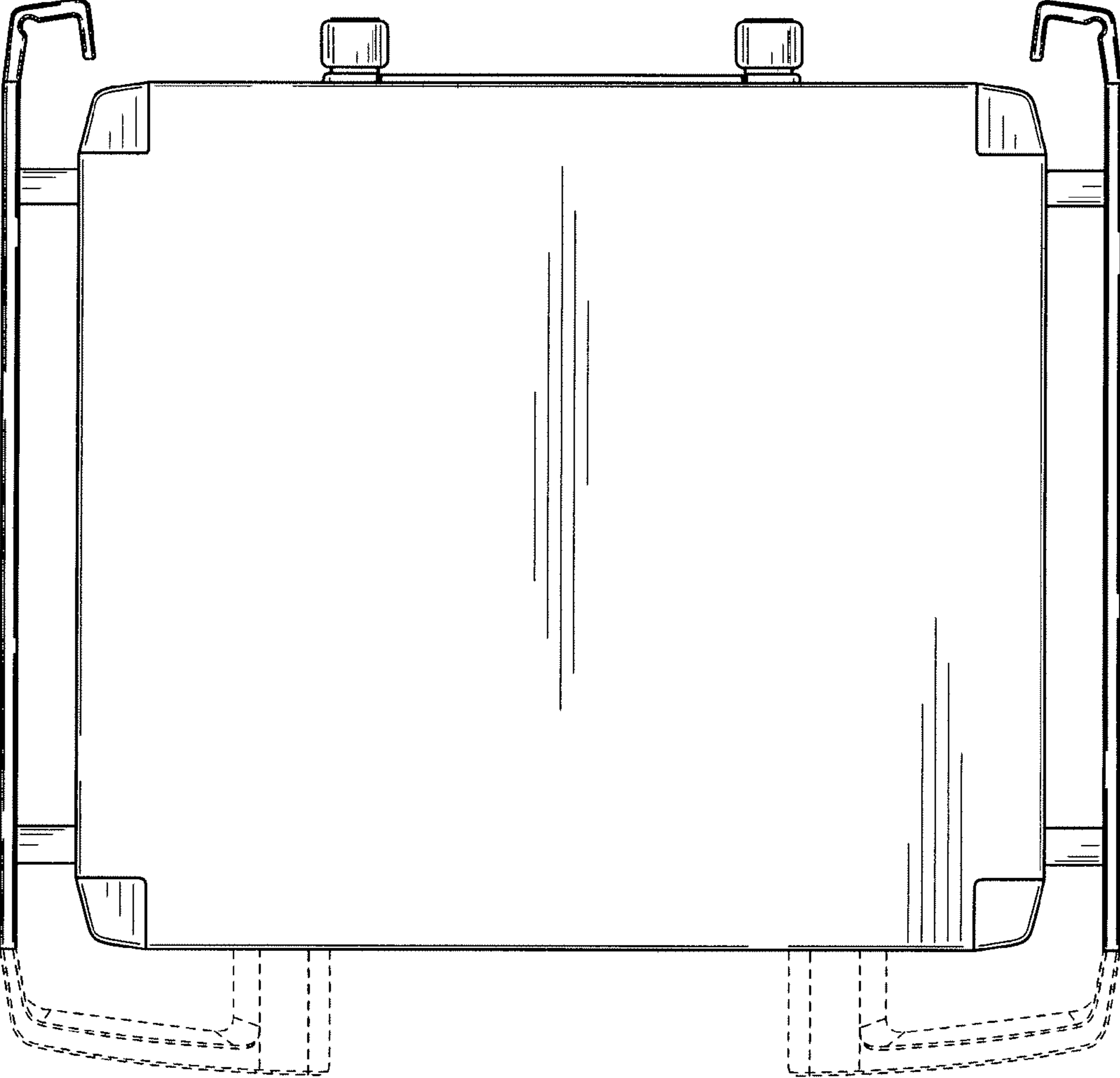

FIG. 6

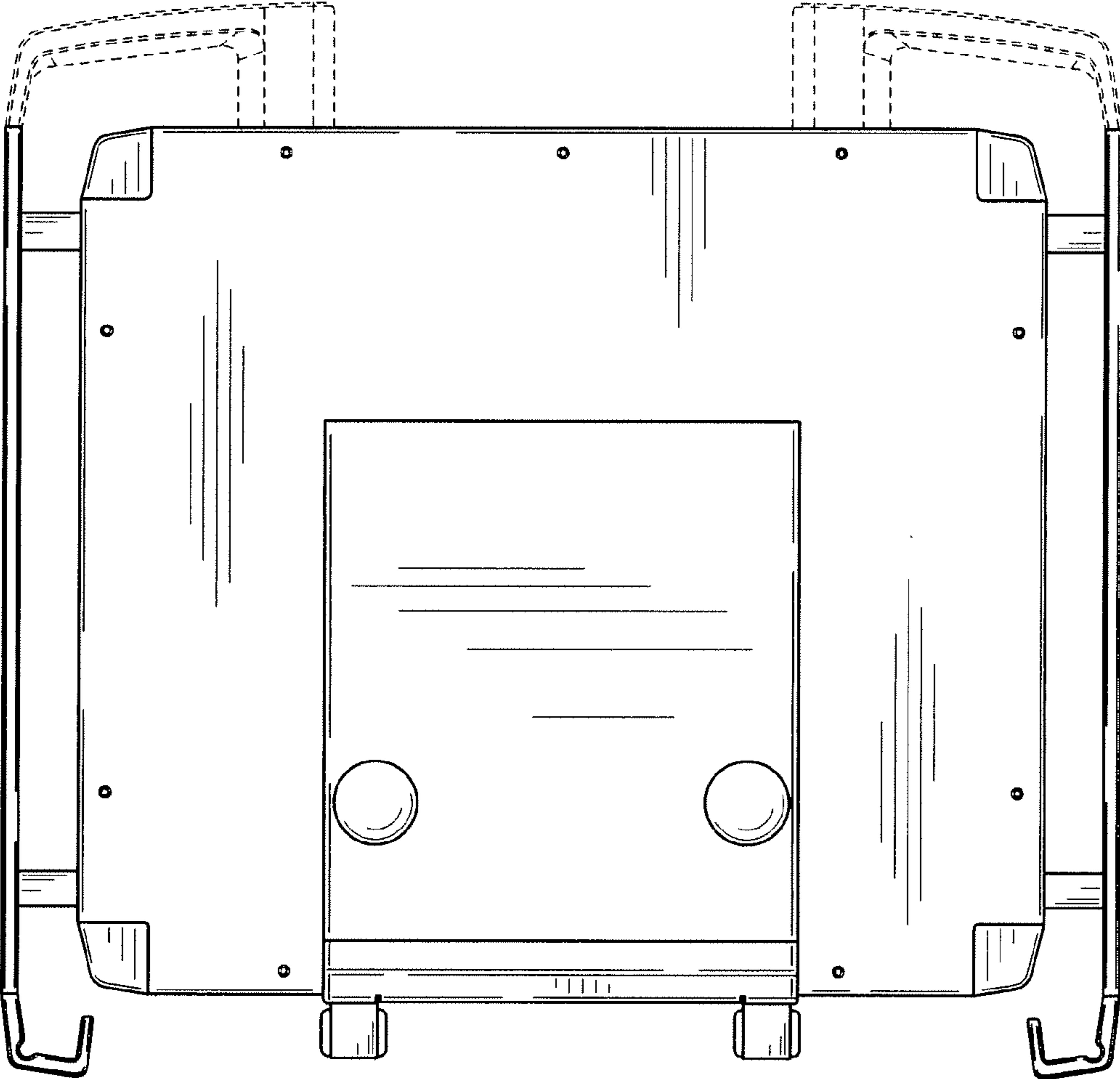

FIG. 7

UNITED STATES PATENT AND TRADEMARK OFFICE  
**CERTIFICATE OF CORRECTION**

PATENT NO. : D628,299 S  
APPLICATION NO. : 29/361218  
DATED : November 30, 2010  
INVENTOR(S) : Fred Held

Page 1 of 1

It is certified that error appears in the above-identified patent and that said Letters Patent is hereby corrected as shown below:

On the first page, after "Assignee:" please delete "Trumpf Medizia Systeme GmbH + Co. KG" and insert --**Trumpf Medizin Systeme GmbH + Co. KG**--.

Signed and Sealed this  
Eighth Day of March, 2011

A handwritten signature in black ink that reads "David J. Kappos". The signature is written in a cursive, slightly slanted style.

David J. Kappos  
*Director of the United States Patent and Trademark Office*