



US00D628289S

(12) **United States Design Patent**  
**Romero**

(10) **Patent No.:** **US D628,289 S**  
(45) **Date of Patent:** **\*\* Nov. 30, 2010**

(54) **SURGICAL INSTRUMENT HANDLE**

(75) Inventor: **Paul R. Romero**, Loveland, CO (US)

(73) Assignee: **TYCO Healthcare Group LP**, Boulder, CO (US)

(\*\*) Term: **14 Years**

(21) Appl. No.: **29/351,082**

(22) Filed: **Nov. 30, 2009**

(51) **LOC (9) Cl.** ..... **24-02**

(52) **U.S. Cl.** ..... **D24/133; D24/146**

(58) **Field of Classification Search** ..... D24/133,  
D24/143-147, 170; D8/80, 83, 94, 107,  
D8/68; 606/1, 139, 144, 148, 39, 170, 48,  
606/42, 32, 45-50, 184-185, 167, 208; 600/201-203,  
600/210, 213, 215, 221, 223, 225-227  
See application file for complete search history.

(56) **References Cited**

U.S. PATENT DOCUMENTS

1,908,201	A *	5/1933	Welch et al.	.....	D24/143
3,572,325	A	3/1971	Bazell et al.		
D249,549	S *	9/1978	Pike	.....	D24/144
D298,353	S *	11/1988	Manno	.....	D24/133
5,250,063	A	10/1993	Abidin et al.		
5,273,026	A	12/1993	Wilk		
D343,453	S *	1/1994	Noda	.....	D24/133
5,275,608	A	1/1994	Forman et al.		
5,405,344	A	4/1995	Williamson et al.		
D358,887	S *	5/1995	Feinberg	.....	D24/143
5,520,678	A	5/1996	Heckele et al.		
5,626,609	A	5/1997	Zvenyatsky et al.		
5,695,522	A	12/1997	LeMaire, III et al.		
5,792,165	A	8/1998	Klieman et al.		
5,800,449	A *	9/1998	Wales	.....	606/170
5,817,119	A	10/1998	Klieman et al.		
5,827,323	A	10/1998	Klieman et al.		
6,443,973	B1	9/2002	Whitman		

6,569,105	B1	5/2003	Kortenbach et al.		
6,666,854	B1	12/2003	Lange		
D496,997	S *	10/2004	Dycus et al.	.....	D24/144

(Continued)

FOREIGN PATENT DOCUMENTS

JP 2001-276091 9/2001

(Continued)

*Primary Examiner*—Ian Simmons  
*Assistant Examiner*—Wan Laymon

(57) **CLAIM**

The ornamental design for a surgical instrument handle, as shown and described.

**DESCRIPTION**

FIG. 1 is a front and left side perspective view of a surgical instrument handle in accordance with the present design;

FIG. 2 is a top and left-side perspective view of the surgical instrument handle of FIG. 1;

FIG. 3 is a top plan view of the surgical instrument handle of FIG. 1;

FIG. 4 is a bottom plan view of the surgical instrument handle of FIG. 1;

FIG. 5 is a front elevation view of the surgical instrument handle of FIG. 1;

FIG. 6 is a rear elevation view of the surgical instrument handle of FIG. 1; and,

FIG. 7 is a right-side elevation view of the surgical instrument handle of FIG. 1, a left-side elevation view being a mirror image of FIG. 7.

The broken lines showing portions of the surgical instrument handle are included for the purpose of illustrating environmental structure and form no part of the claimed design.

**1 Claim, 5 Drawing Sheets**

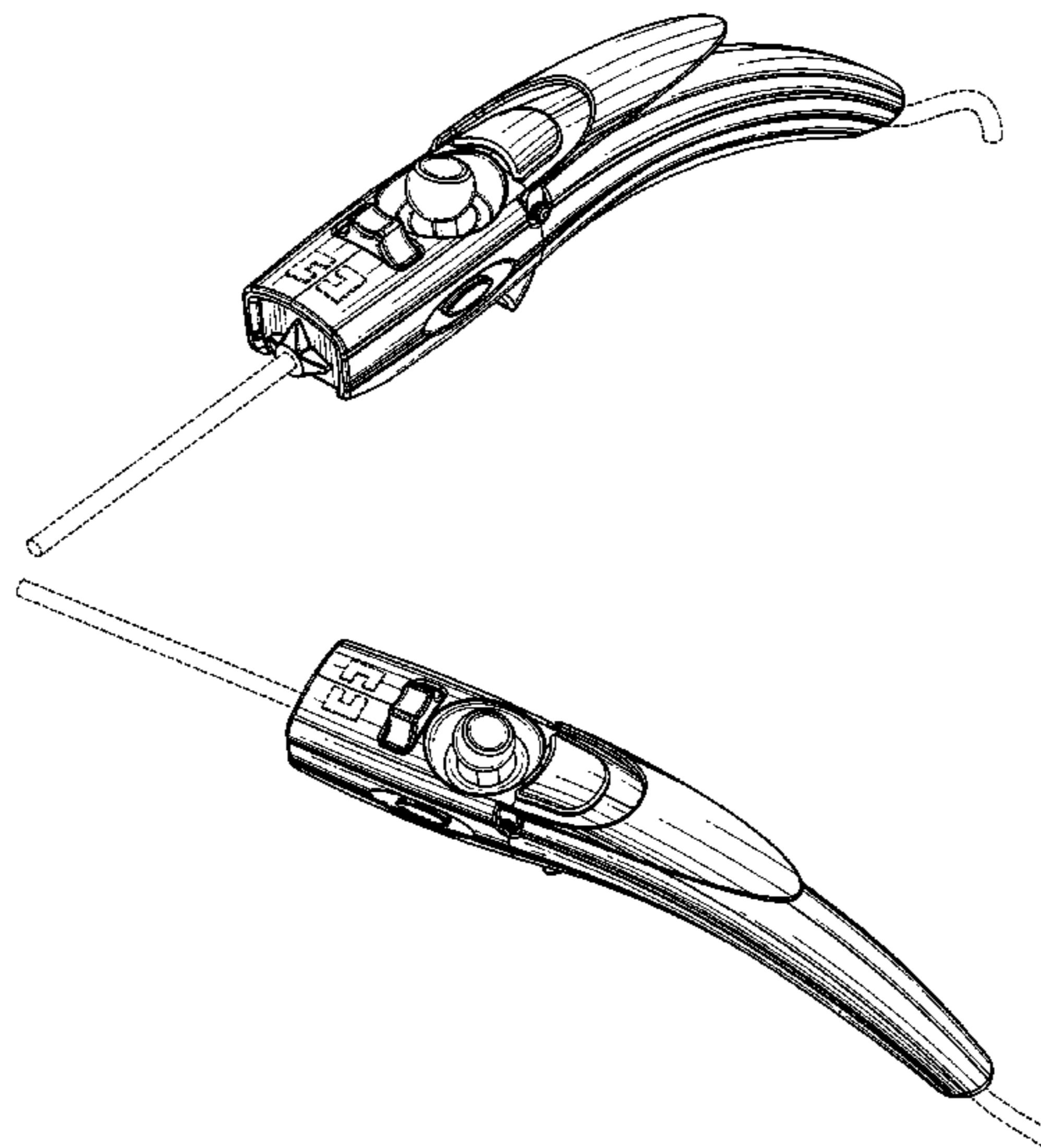

# US D628,289 S

Page 2

---

## U.S. PATENT DOCUMENTS

6,858,005 B2 2/2005 Ohline et al.  
7,083,620 B2 8/2006 Jahns et al.  
D533,274 S \* 12/2006 Visconti et al. .... D24/133  
D541,611 S \* 5/2007 Aglassinger ..... D8/68  
D547,154 S \* 7/2007 Lee ..... D8/68  
D575,401 S \* 8/2008 Hixson et al. .... D24/144  
D582,038 S \* 12/2008 Swoyer et al. .... D24/144  
7,615,067 B2 11/2009 Lee et al.

2005/0187575 A1 8/2005 Hallbeck et al.  
2007/0095355 A1 5/2007 Oomori et al.  
2008/0046000 A1 2/2008 Lee et al.  
2009/0054734 A1 2/2009 DeSantis et al.  
2009/0105750 A1\* 4/2009 Price et al. .... 606/1

## FOREIGN PATENT DOCUMENTS

WO 95/07662 3/1995

\* cited by examiner

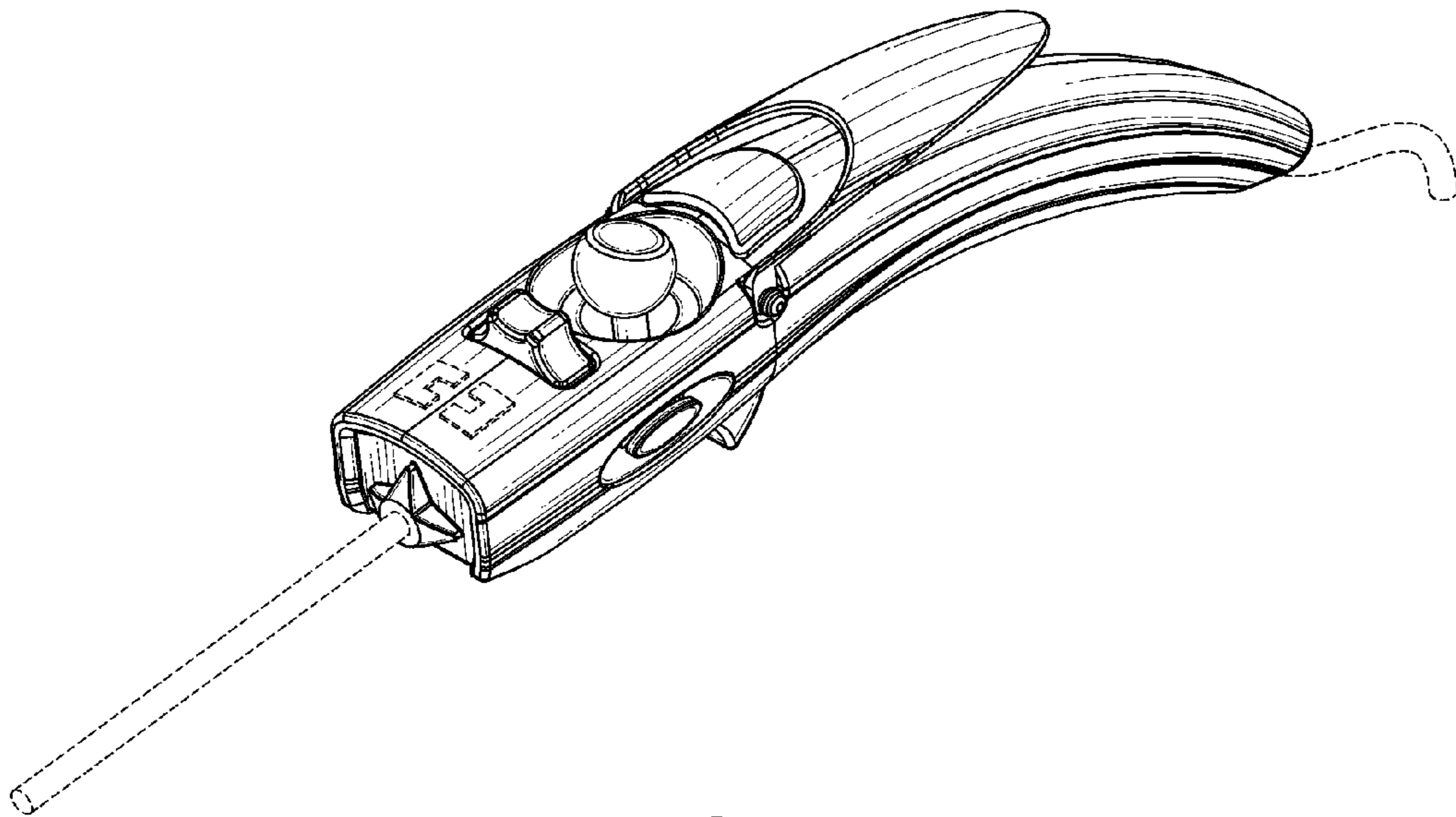

FIG. 1

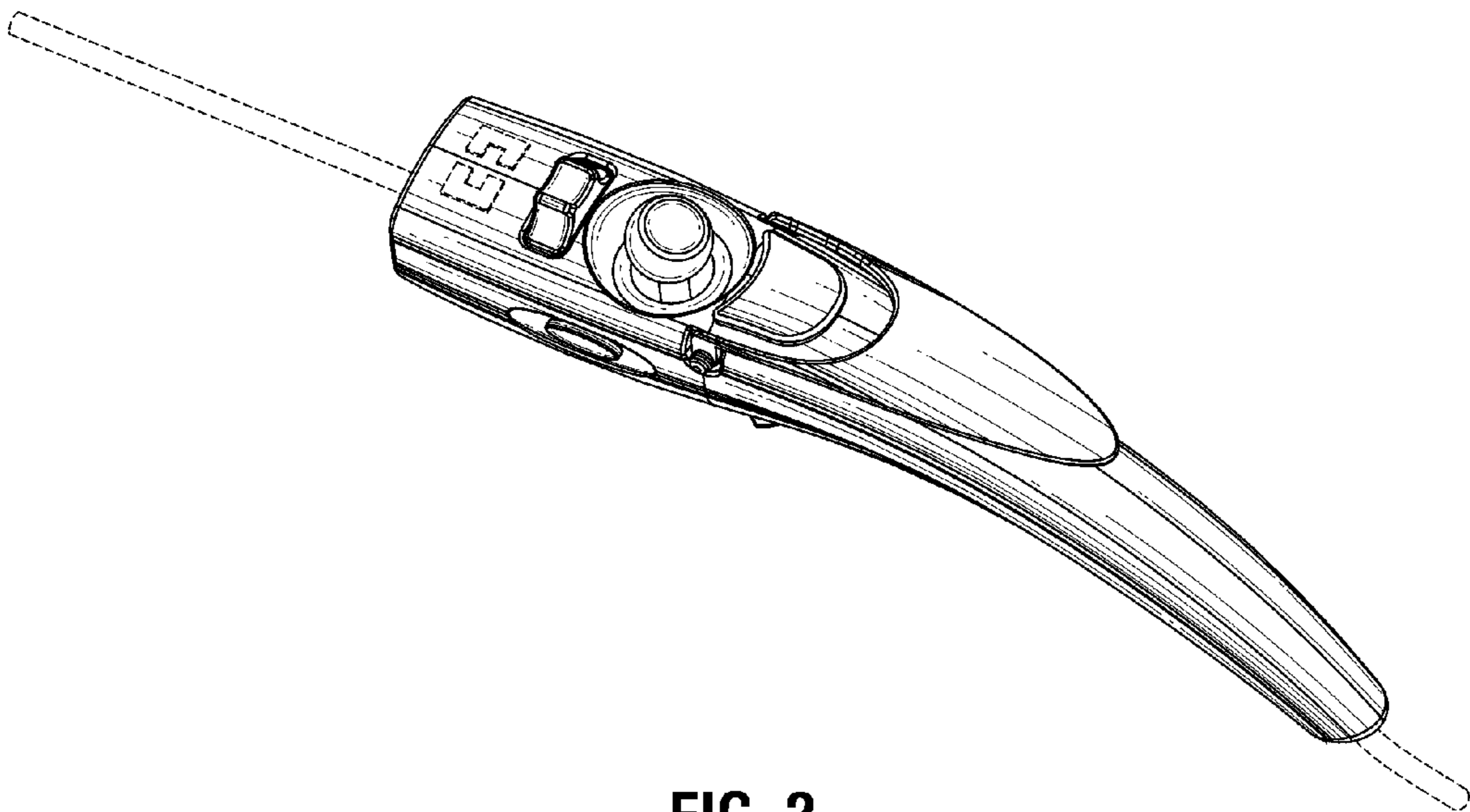

FIG. 2

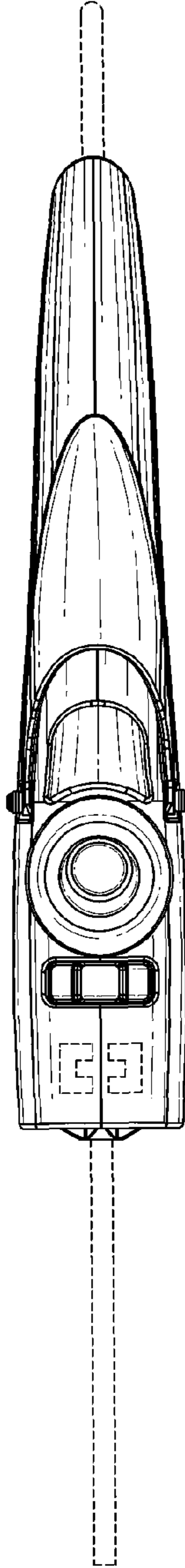

FIG. 3

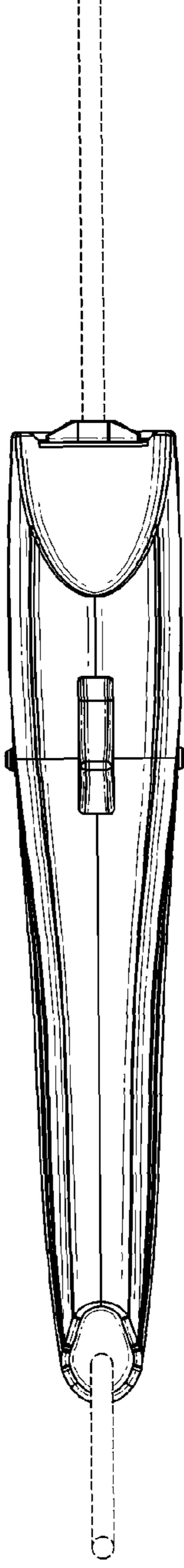

FIG. 4

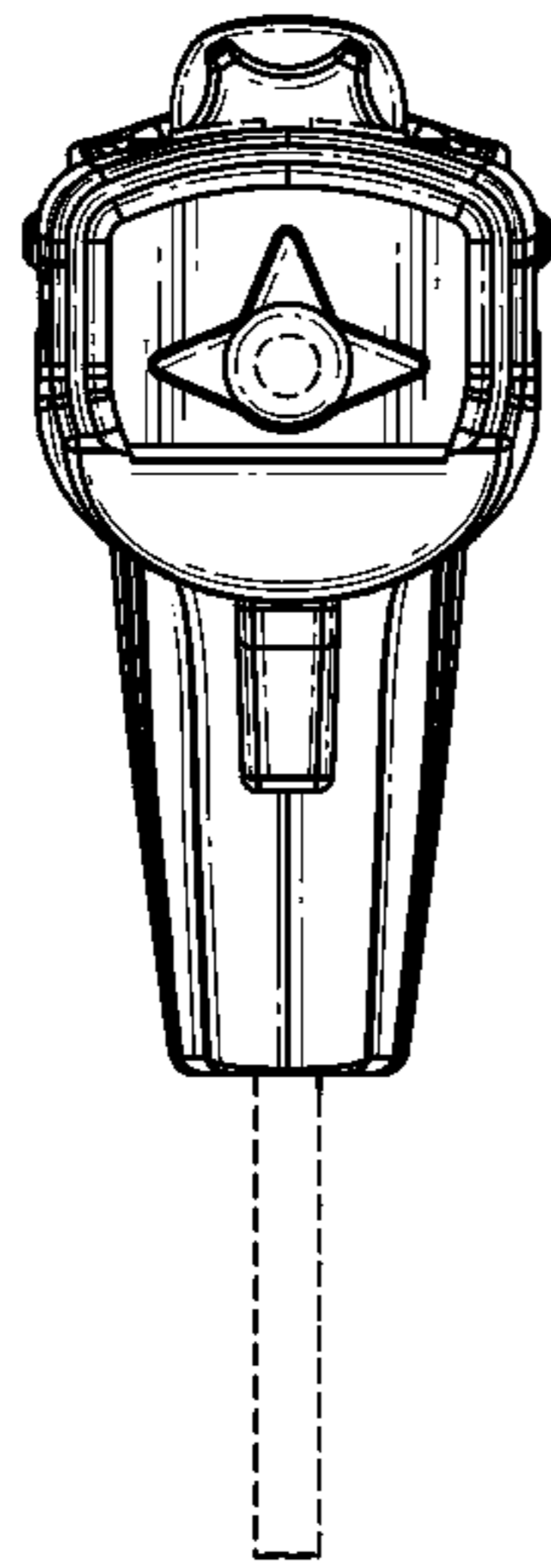

FIG. 5

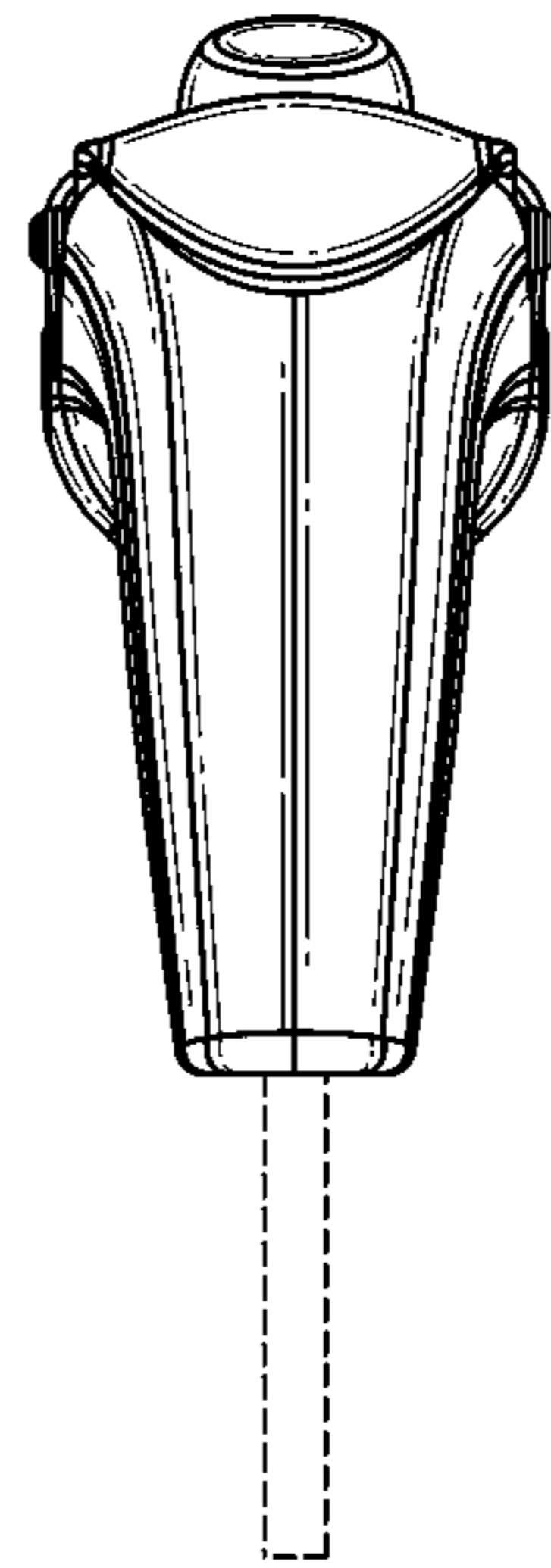

FIG. 6



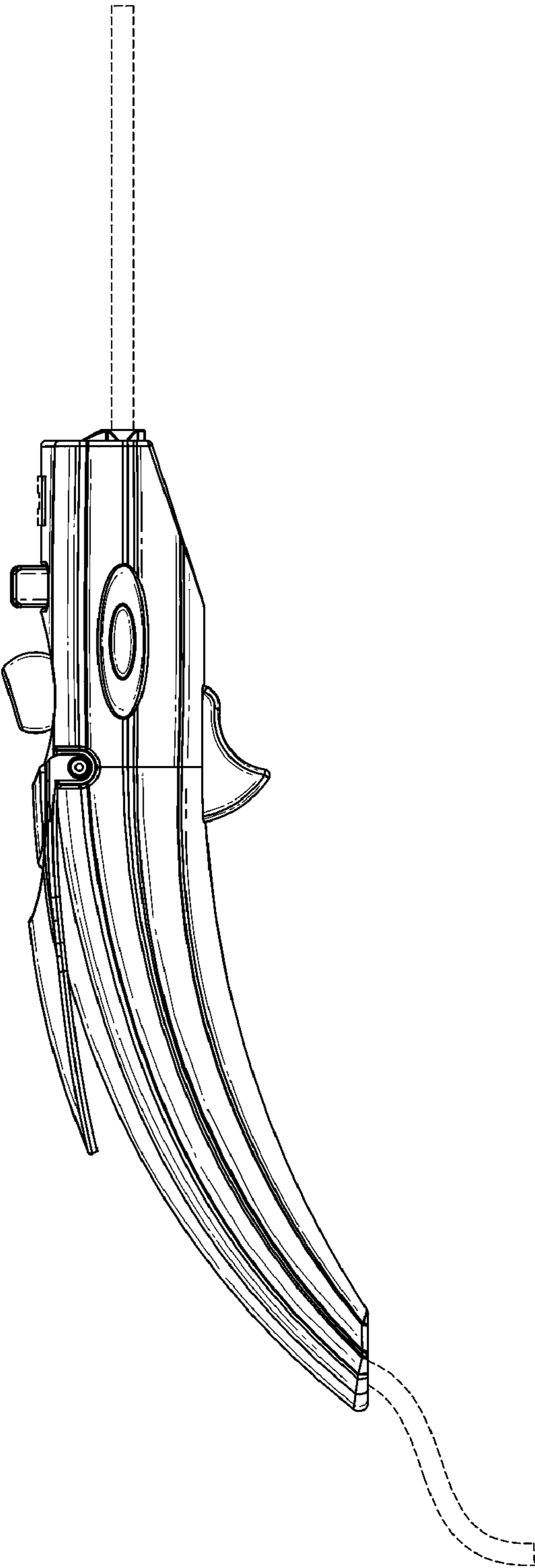

FIG. 7