



US00D628201S

(12) **United States Design Patent**
Tian et al.

(10) **Patent No.:** **US D628,201 S**

(45) **Date of Patent:** **** Nov. 30, 2010**

(54) **BASE OF PERSONAL FINANCIAL DEVICE**

(76) Inventors: **WeiCheng Tian**, Room 704, No. I, 519 Lane, ChanDe road, JingAn district, ShangHai (CN); **Yi Dong**, 666# East Beijing Road, section-C No., 9th floor, Shanghai (CN)

(**) Term: **14 Years**

(21) Appl. No.: **29/316,640**

(22) Filed: **Oct. 19, 2009**

(51) **LOC (9) Cl.** **14-02**

(52) **U.S. Cl.** **D14/434; D18/4.4; D18/4.5**

(58) **Field of Classification Search** D14/432-434, D14/314, 204, 420, 421, 447, 217; D13/108, D13/146; D23/314, 328; 248/346.03; 361/679.41, 361/679.31, 679.32, 679.4, 679.43, 679.01; 70/58; D21/333; 320/112, 109; 348/375; 381/333; D18/4.4, 4.5

See application file for complete search history.

(56) **References Cited**

U.S. PATENT DOCUMENTS

5,627,727 A * 5/1997 Aguilera et al. 361/679.43
D422,622 S * 4/2000 Ono D18/12.2
D427,231 S * 6/2000 Ono D18/4.6
6,290,534 B1 * 9/2001 Sadler 439/534

D462,347 S * 9/2002 Baldauf D14/314
6,947,280 B2 * 9/2005 Li 361/679.46
D528,146 S * 9/2006 Fitch D18/4.4
D584,731 S * 1/2009 Montgomery et al. D14/434
D589,964 S * 4/2009 Heggland et al. D14/434
D596,175 S * 7/2009 Viertola et al. D14/314
2006/0067043 A1 * 3/2006 Kotani et al. 361/685

* cited by examiner

Primary Examiner—Freda S Nunn

(74) *Attorney, Agent, or Firm*—Raymond Y. Chan; David and Raymond Patent Firm

(57) **CLAIM**

The ornamental design for a base of personal financial device, as shown and described.

DESCRIPTION

FIG. 1 is a perspective view of base of personal financial device showing my new design.

FIG. 2 is a front view thereof.

FIG. 3 is a rear view thereof.

FIG. 4 is a right end view thereof.

FIG. 5 is a left end view thereof.

FIG. 6 is a top view thereof; and,

FIG. 7 is a bottom view thereof.

1 Claim, 7 Drawing Sheets

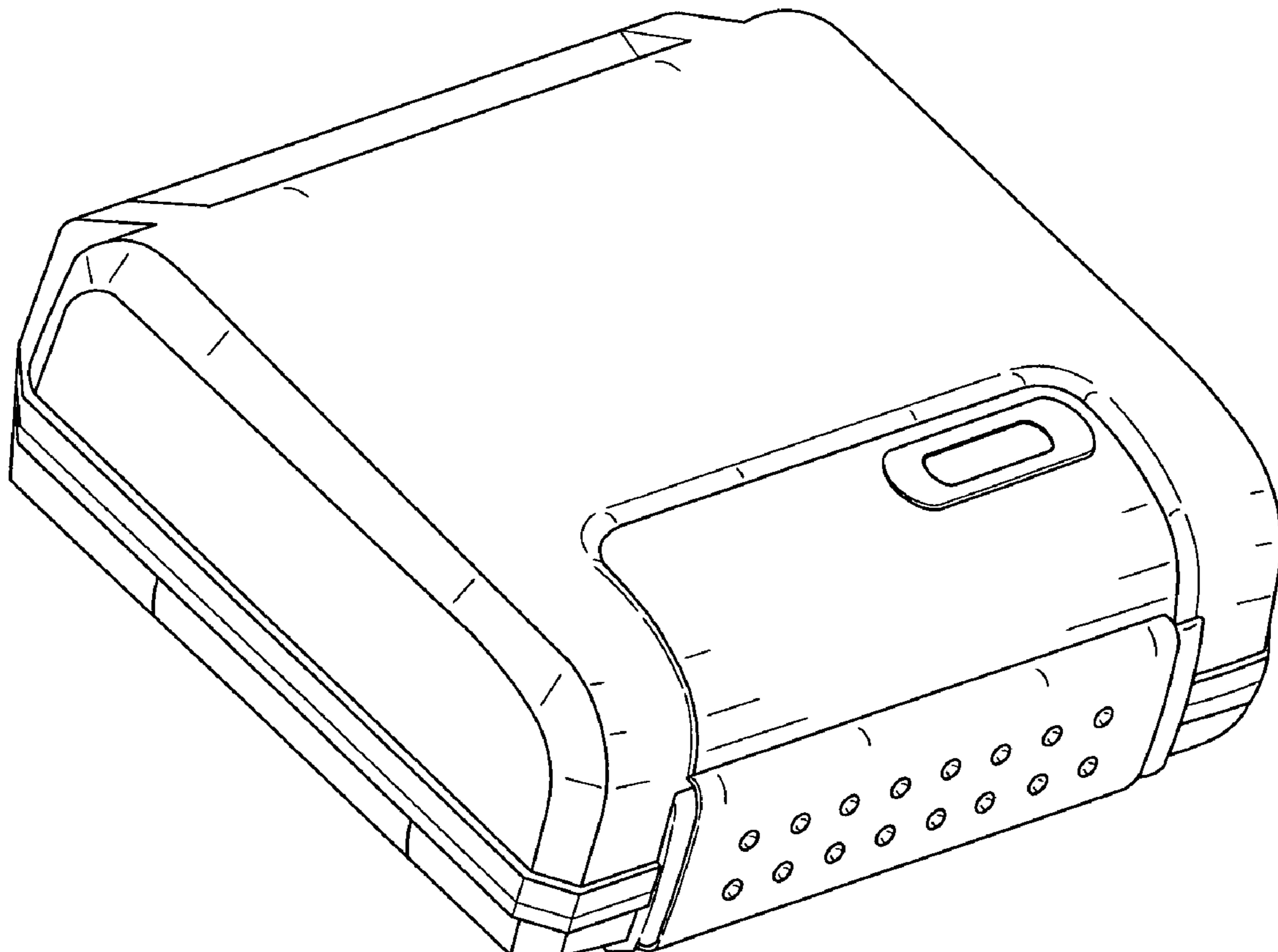

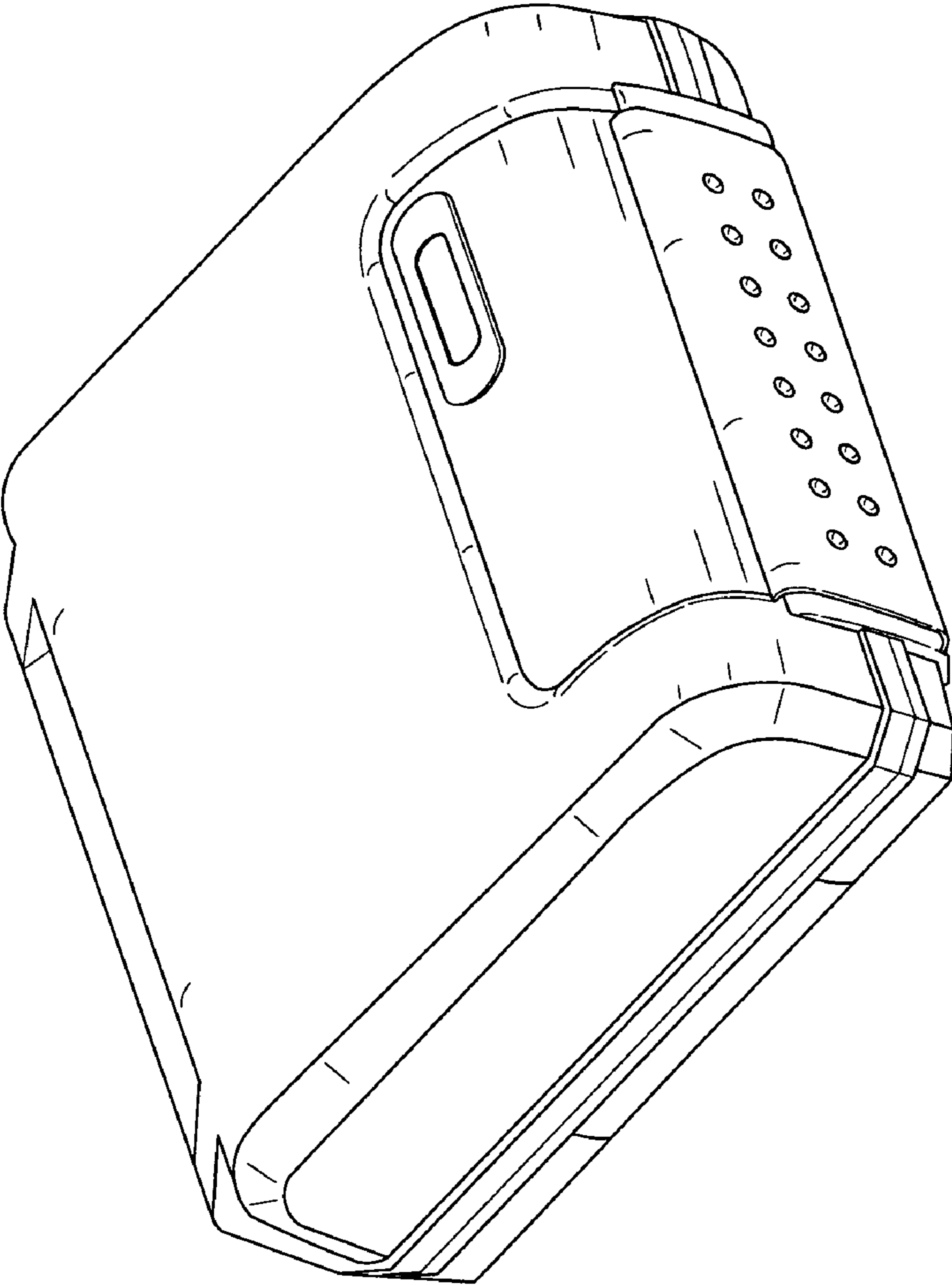

FIG.1

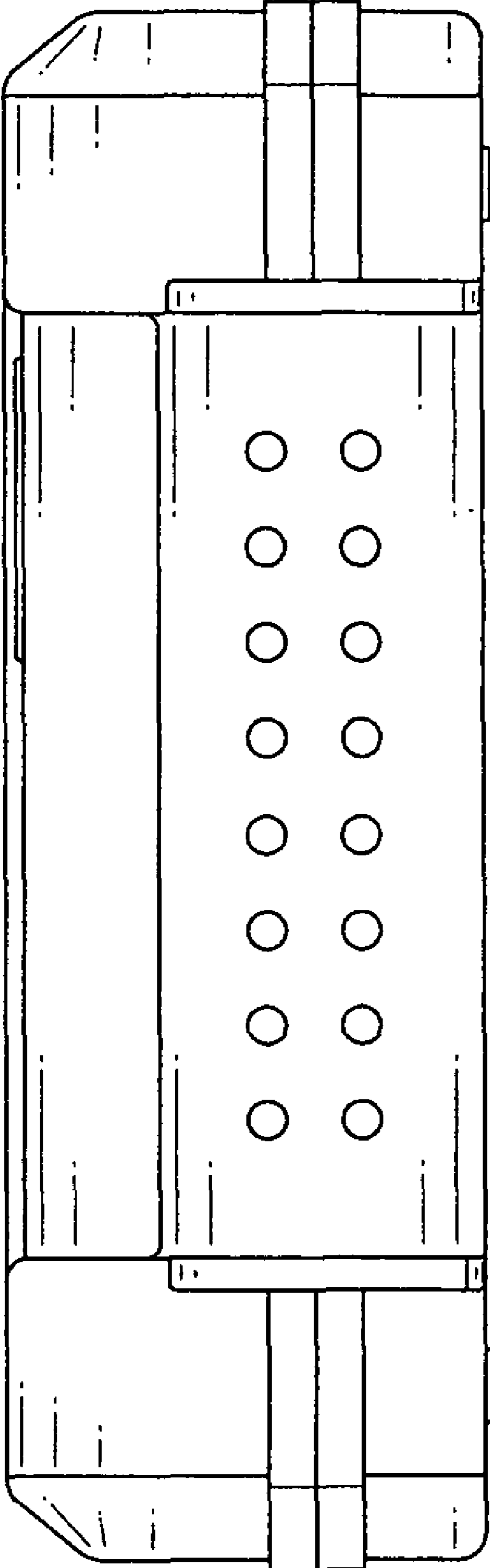

FIG. 2

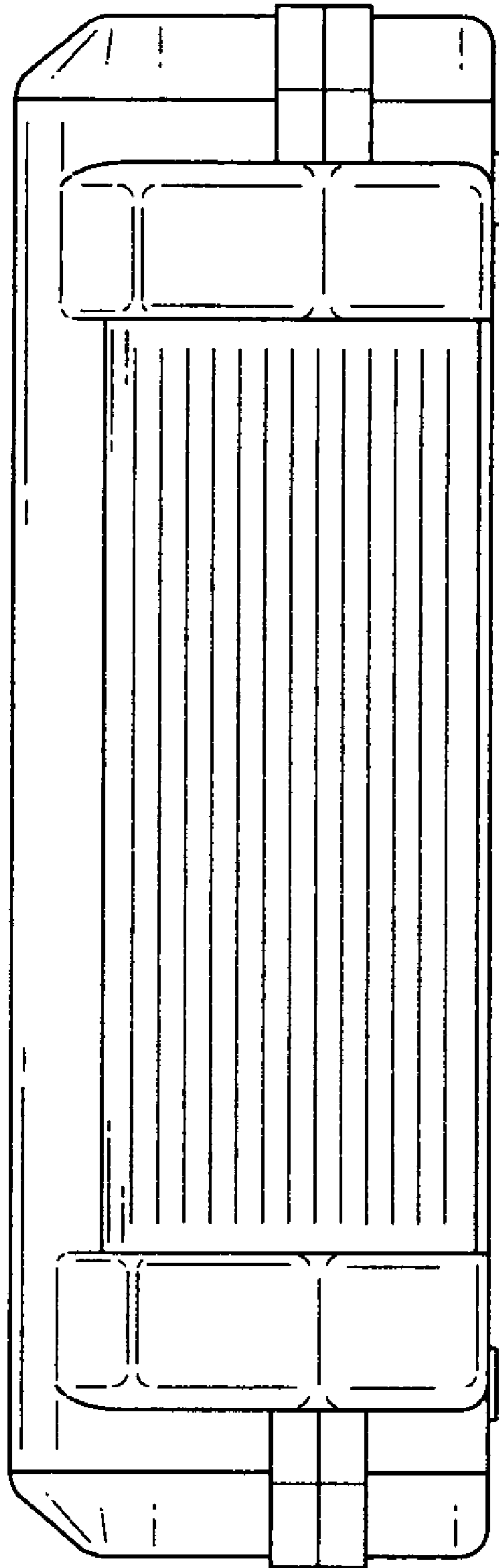

FIG. 3

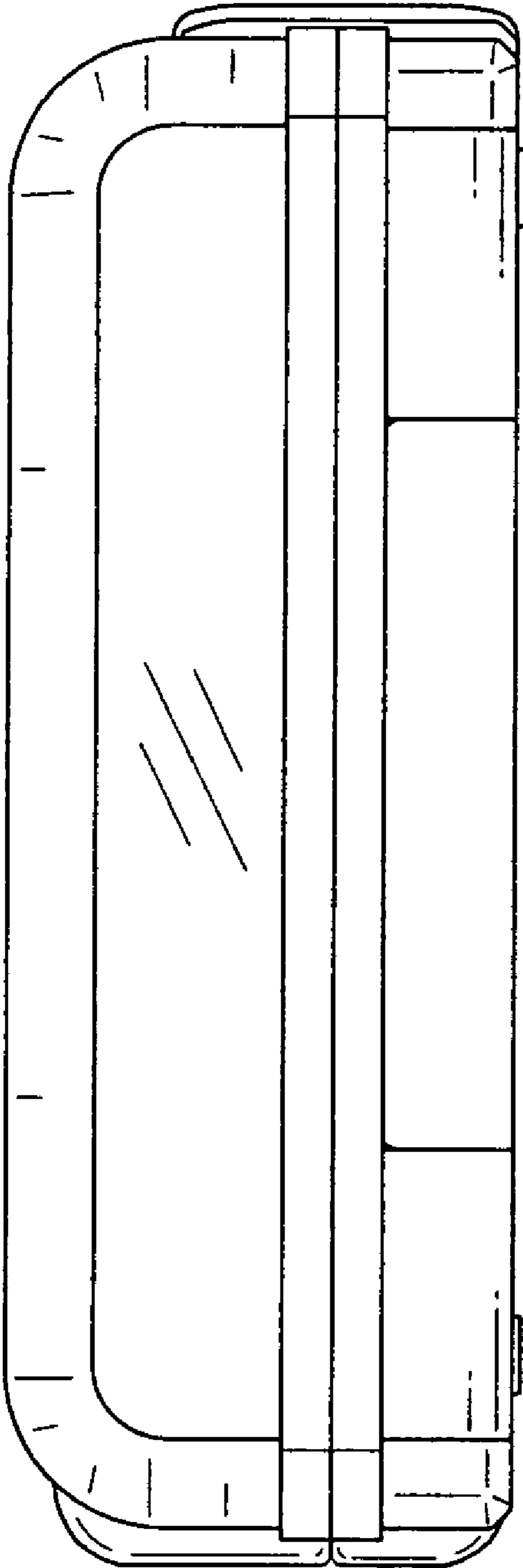

FIG.4

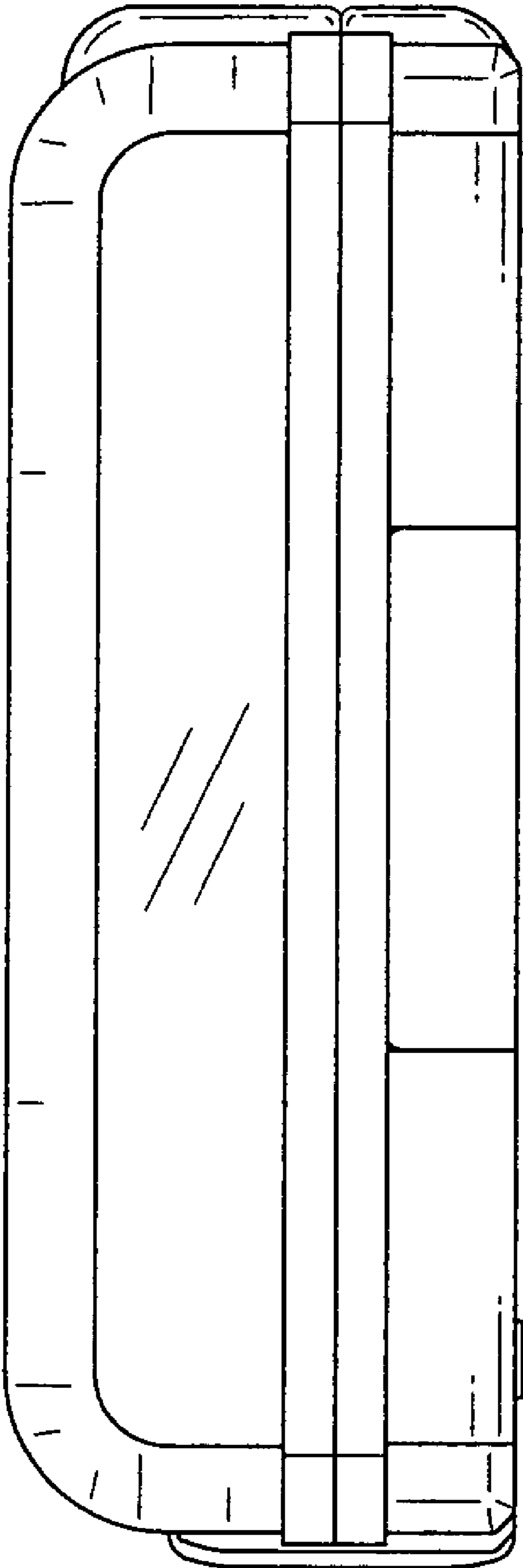

FIG. 5

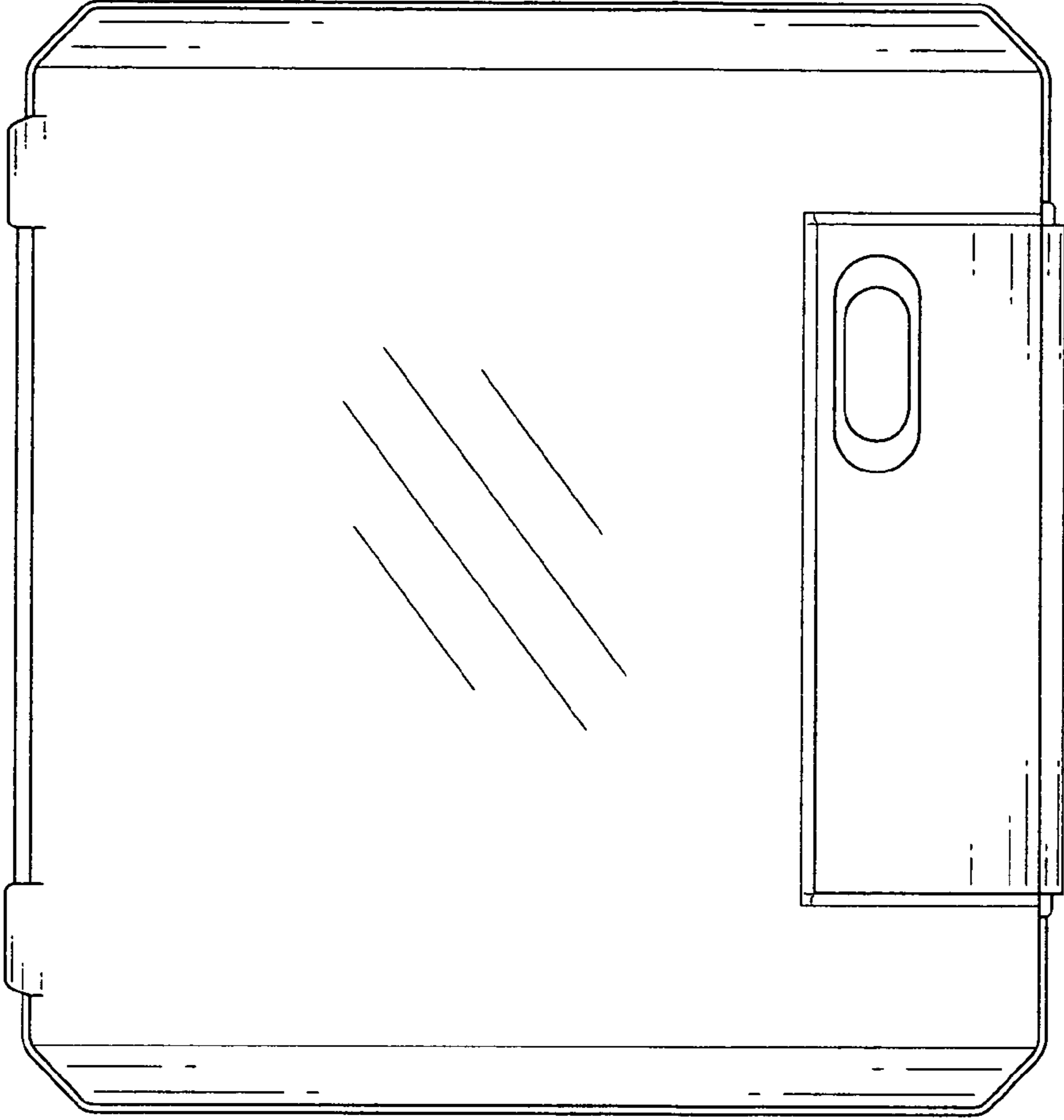

FIG.6

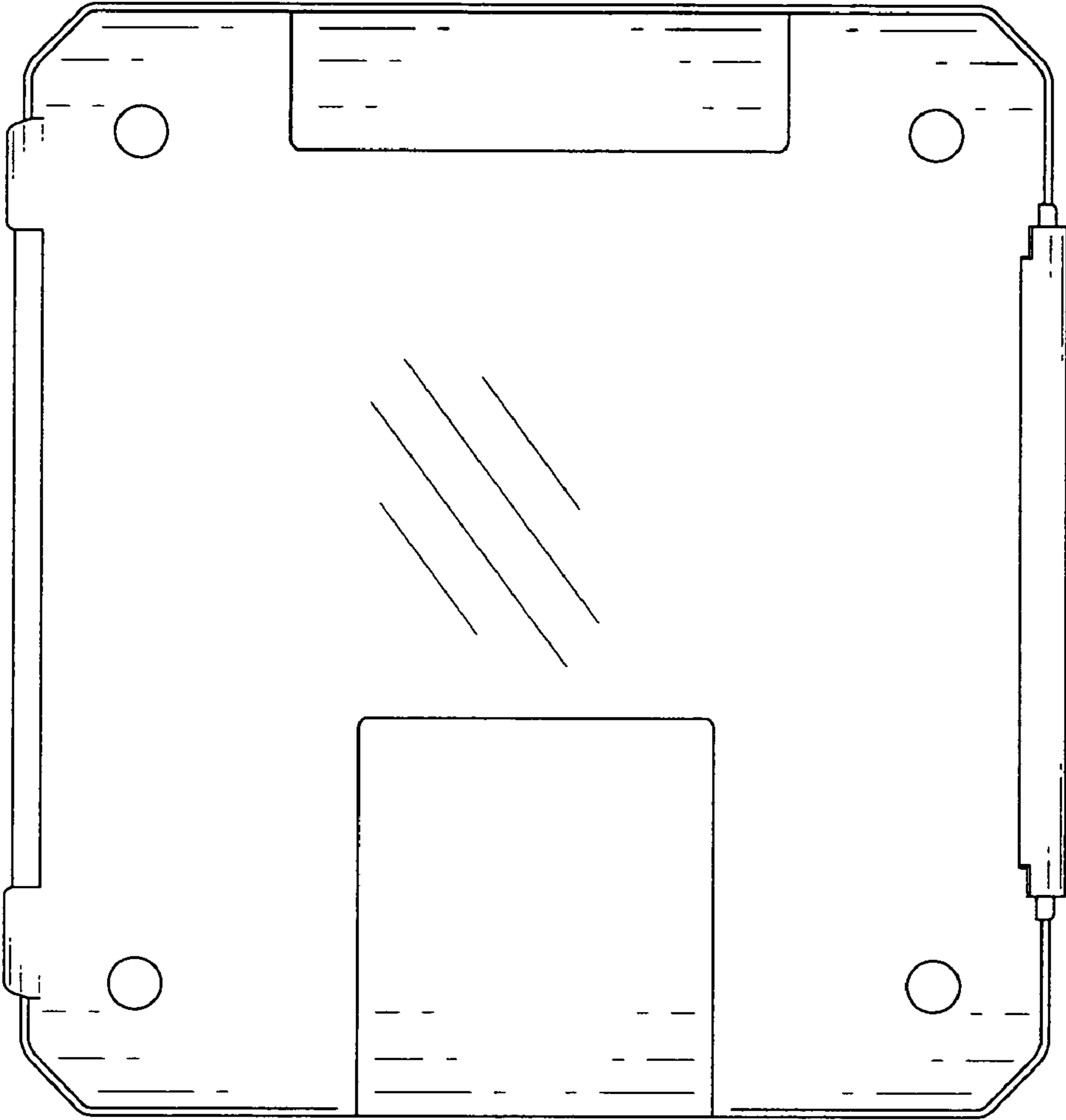

FIG.7