



US00D628074S

(12) **United States Design Patent**
Mero et al.

(10) **Patent No.:** **US D628,074 S**

(45) **Date of Patent:** **** Nov. 30, 2010**

(54) **BOTTLE**

(75) Inventors: **Christopher J. Mero**, New Milford, CT (US); **Damien Bourne**, Honfleur (FR); **Laurent Lepoitevin**, Montivilliers (FR); **Shriram Venkataraman**, Danbury, CT (US); **Robert N. Le Bras-Brown**, New York, NY (US)

(73) Assignee: **PepsiCo, Inc.**, Purchase, NY (US)

(**) Term: **14 Years**

(21) Appl. No.: **29/363,240**

(22) Filed: **Jun. 7, 2010**

Related U.S. Application Data

(62) Division of application No. 29/330,738, filed on Jan. 13, 2009, now Pat. No. Des. 619,899.

(51) **LOC (9) Cl.** **09-01**

(52) **U.S. Cl.** **D9/520; D9/552; D9/538; D9/556; D9/557**

(58) **Field of Classification Search** **D9/516-575, D9/434-436; 215/379-384; 220/669-675**
See application file for complete search history.

(56) **References Cited**

U.S. PATENT DOCUMENTS

D212,460 S	10/1968	Pettengill
D387,284 S	12/1997	Briggs et al.
D391,493 S	3/1998	Panella et al.
D406,065 S	2/1999	Cheng
D412,441 S	8/1999	Cheng et al.
D414,112 S	9/1999	Waggaman et al.
D425,424 S	5/2000	Cheng et al.

(Continued)

FOREIGN PATENT DOCUMENTS

EM 000936547-0001 3/2008

(Continued)

OTHER PUBLICATIONS

U.S. Appl. No. 29/297,831, filed Nov. 19, 2007, Gnann et al.

Primary Examiner—Catherine Tuttle

(74) *Attorney, Agent, or Firm*—Banner & Witcoff, Ltd.

(57) **CLAIM**

The ornamental design for a bottle, as shown and described.

DESCRIPTION

FIG. 1 is a front perspective view of a bottle showing a first embodiment of our new design;

FIG. 2 is a front view thereof;

FIG. 3 is a right view thereof;

FIG. 4 is a rear side view thereof;

FIG. 5 is a left side view thereof;

FIG. 6 is a top view thereof;

FIG. 7 is a bottom view thereof;

FIG. 8 is a front perspective view of a bottle showing a second embodiment of our new design;

FIG. 9 is a front view thereof;

FIG. 10 is a right view thereof;

FIG. 11 is a rear side view thereof;

FIG. 12 is a left side view thereof;

FIG. 13 is a top view thereof; and,

FIG. 14 is a bottom view thereof.

The circles formed by uneven length dashes represent unclaimed boundaries of the claimed design. The evenly dashed lines remaining are included for the purpose of illustrating portions of the bottle that form no part of the claimed design.

1 Claim, 12 Drawing Sheets

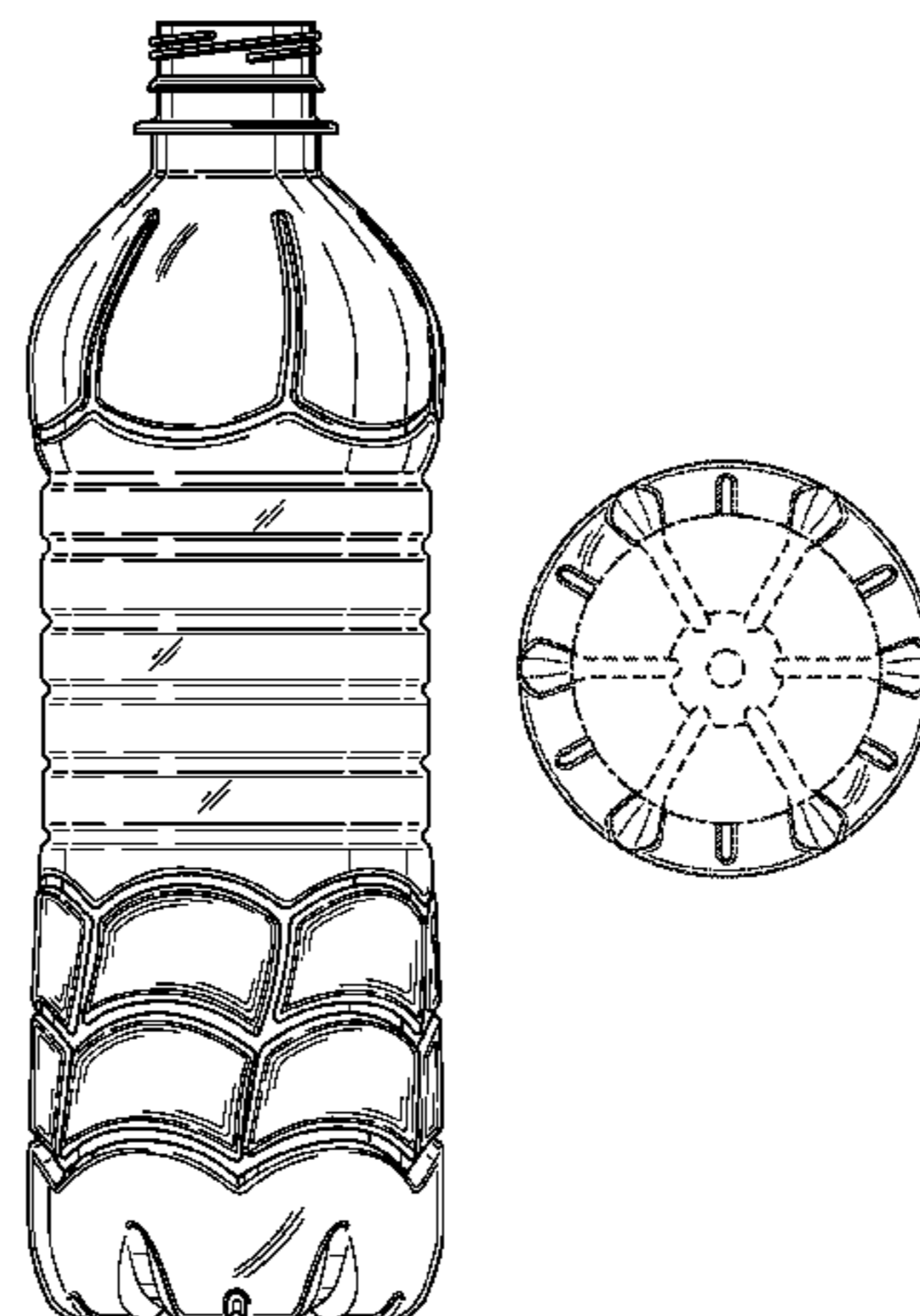

US D628,074 S

Page 2

U.S. PATENT DOCUMENTS

D429,156 S 8/2000 Williams et al.
D435,219 S 12/2000 Williams et al.
D443,519 S 6/2001 Warner et al.
D449,526 S 10/2001 Lichtman et al.
D449,533 S 10/2001 Helps et al.
D461,417 S 8/2002 Jerome
D463,292 S 9/2002 Del Bianco
D507,971 S 8/2005 Harris et al.
6,929,139 B2* 8/2005 Darr 215/382
6,938,788 B2 9/2005 White
D522,874 S 6/2006 Livingston et al.
D523,341 S 6/2006 Livingston et al.
D528,422 S 9/2006 Darr et al.
D556,044 S 11/2007 Hirata
D556,581 S 12/2007 Yamada
D557,609 S 12/2007 Ungrady et al.

D558,581 S 1/2008 Lockman et al.
D560,502 S 1/2008 Darr et al.
D560,506 S 1/2008 Lepoitevin
D574,718 S 8/2008 Lepoitevin
D576,497 S 9/2008 Ozer
D582,775 S 12/2008 Pedmo et al.
D586,224 S 2/2009 Darr et al.
D587,588 S 3/2009 Fraser et al.
D601,030 S 9/2009 Lepoitevin
D601,902 S 10/2009 Bourne
D602,367 S 10/2009 Lepoitevin

FOREIGN PATENT DOCUMENTS

FR DM053514 9/2000
FR 0008806950004 2/2008

* cited by examiner

Fig. 1

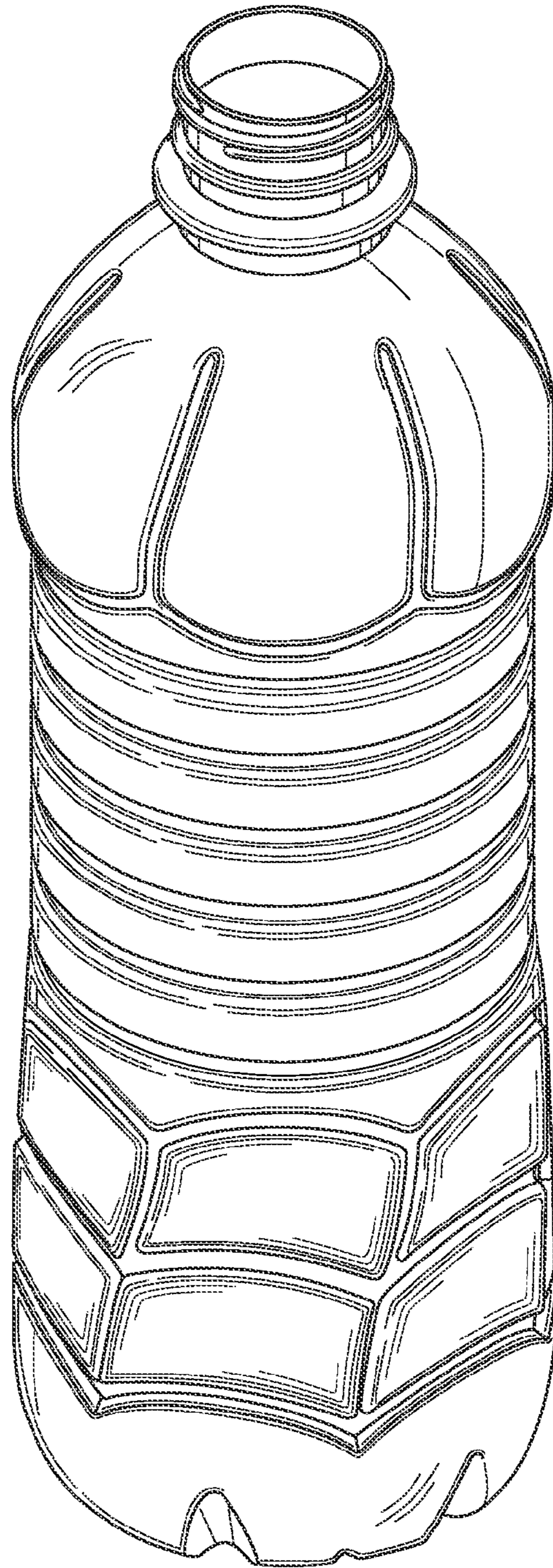

Fig. 2

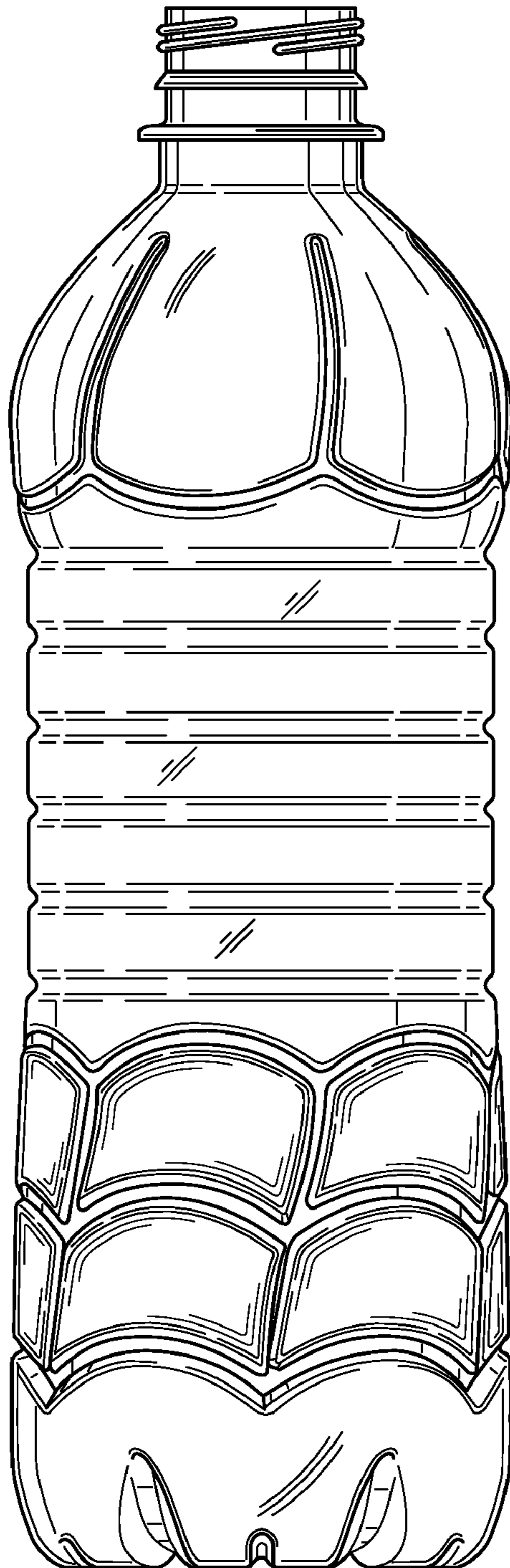

Fig. 3

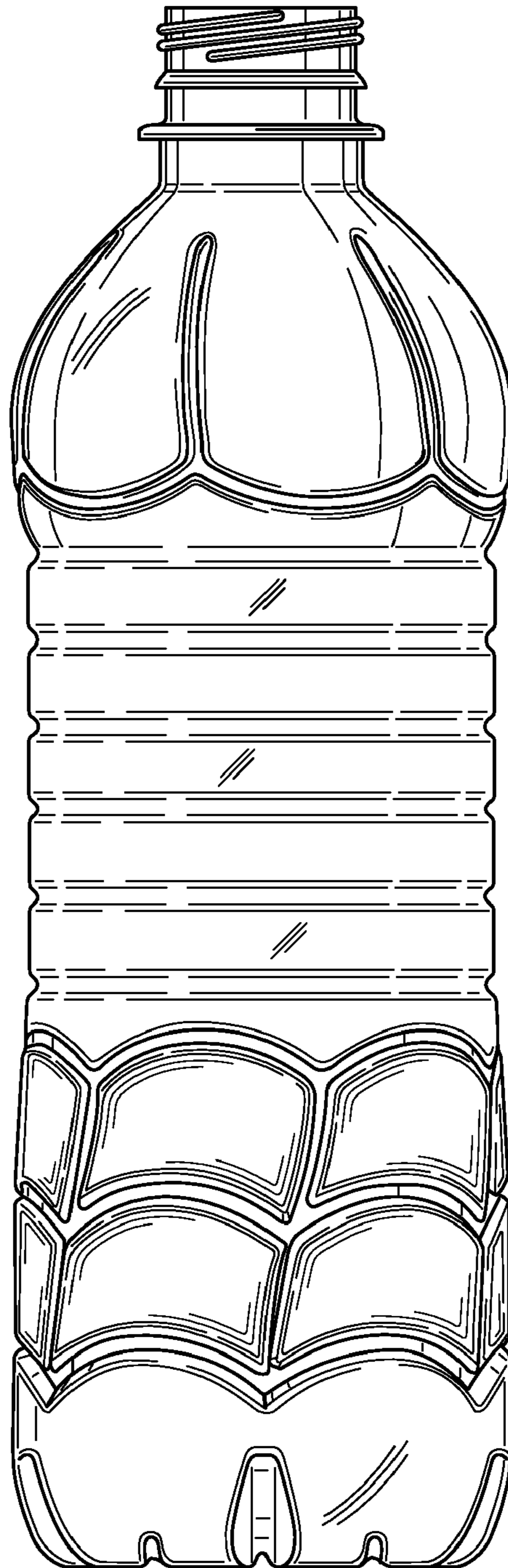

Fig. 4

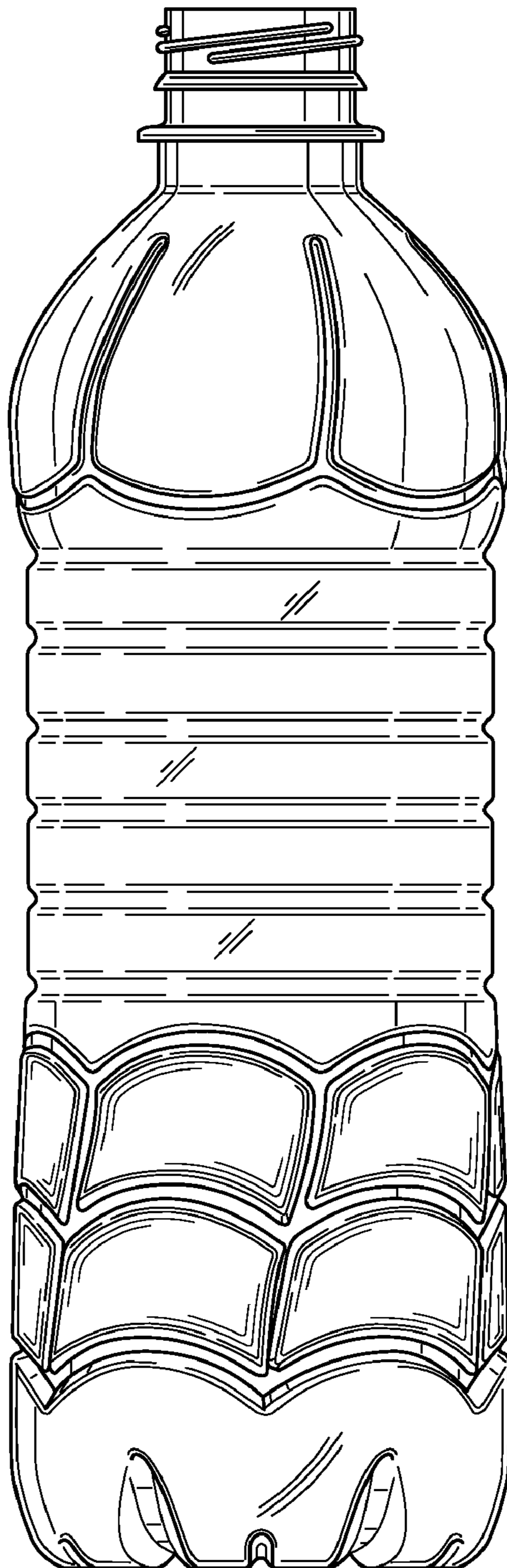

Fig. 5

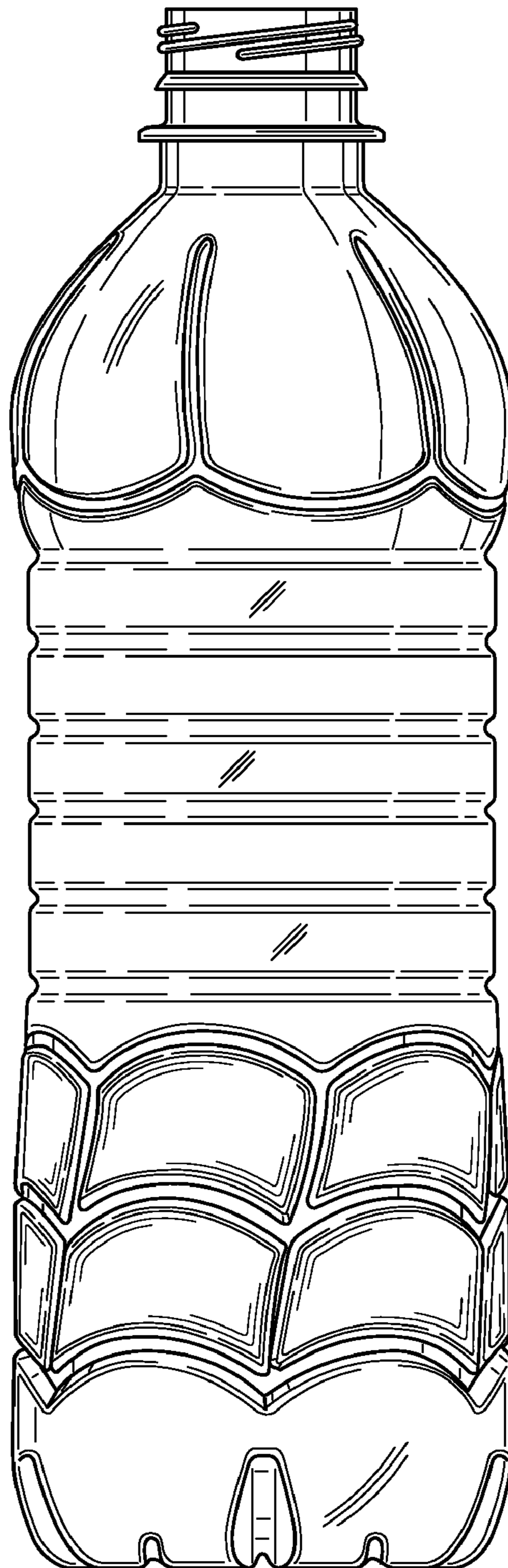

Fig. 6

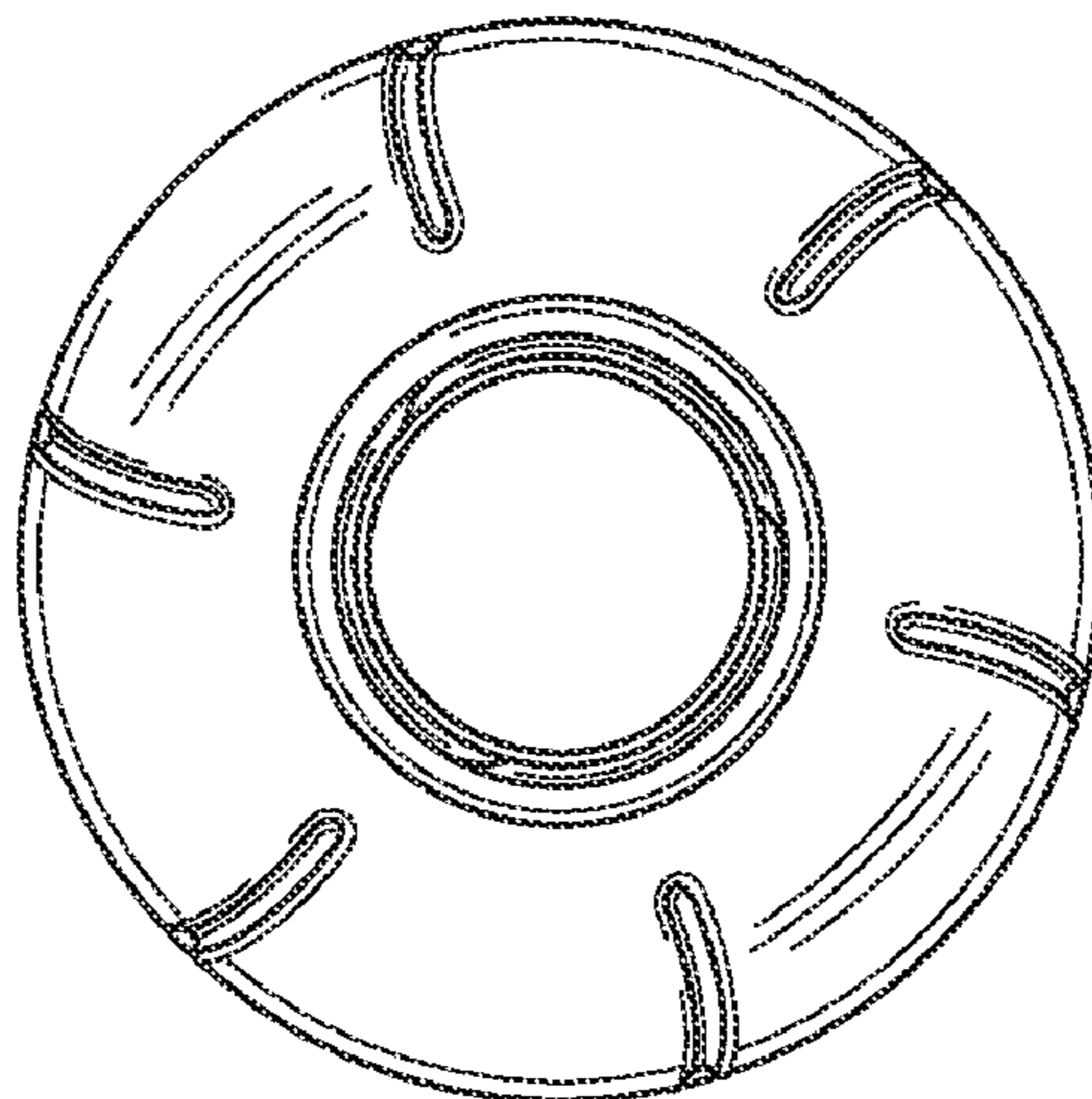

Fig. 7

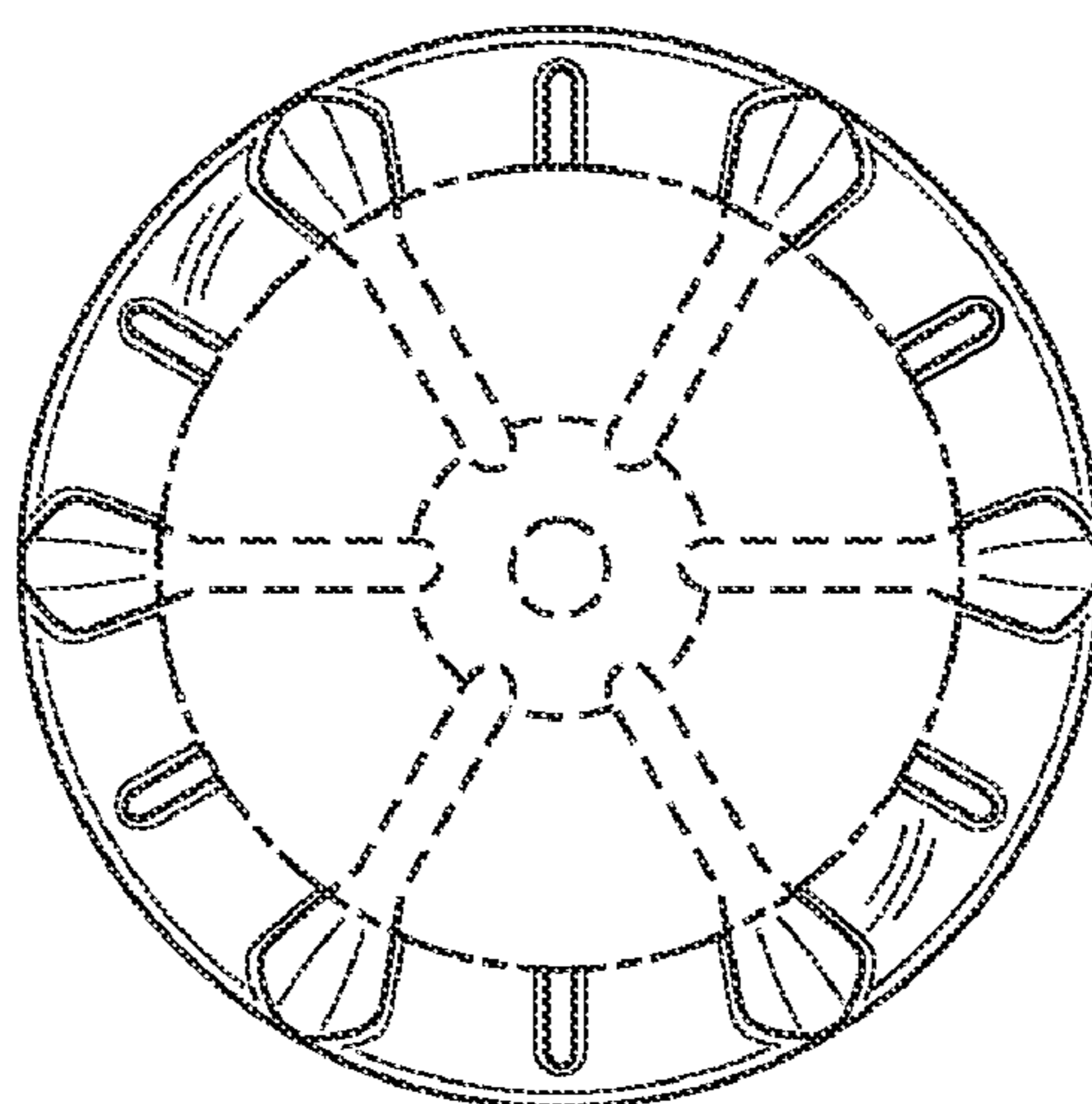

Fig. 8

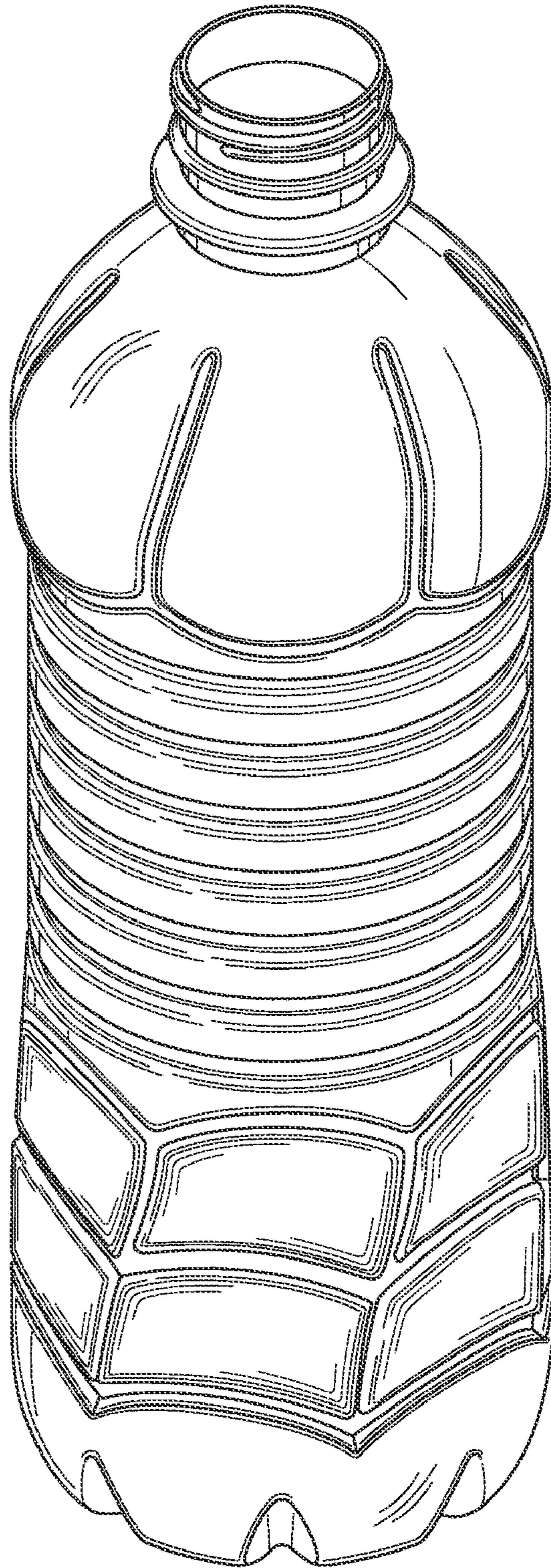

Fig. 9

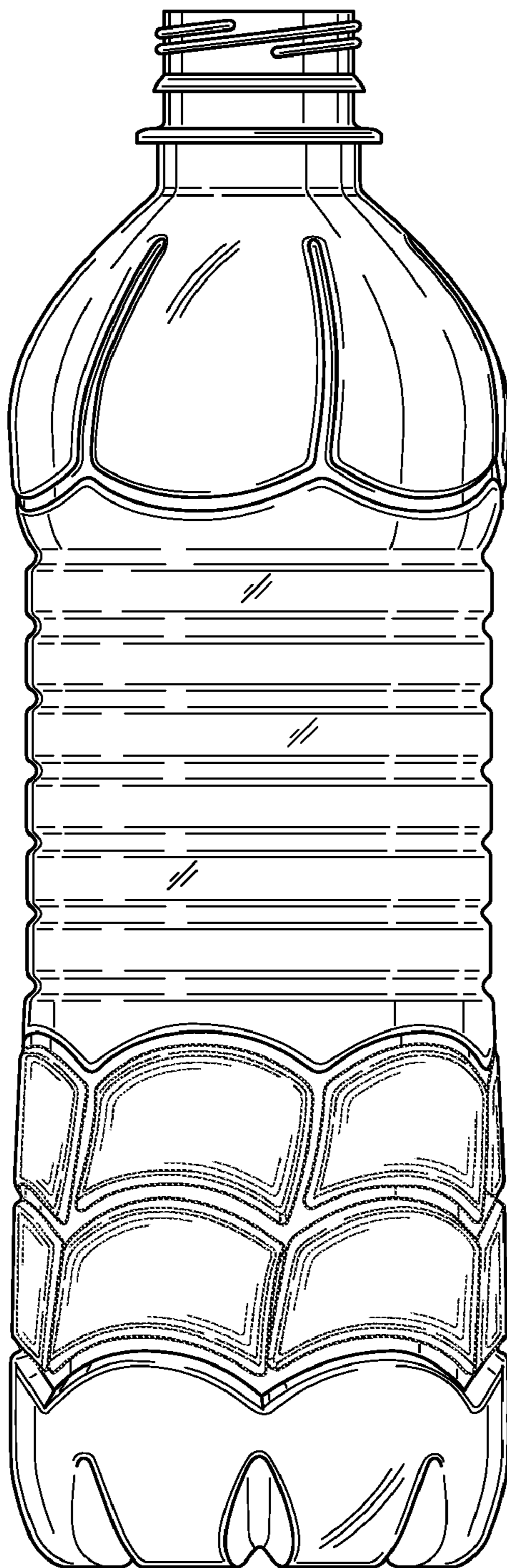

Fig. 10

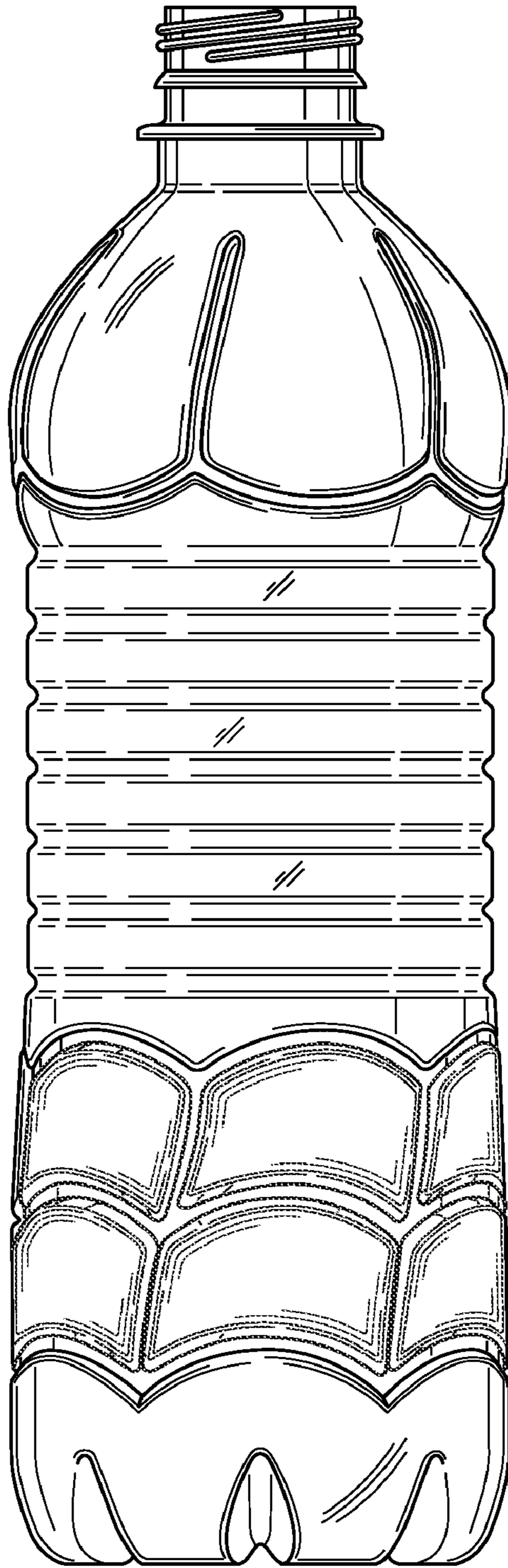

Fig. 11

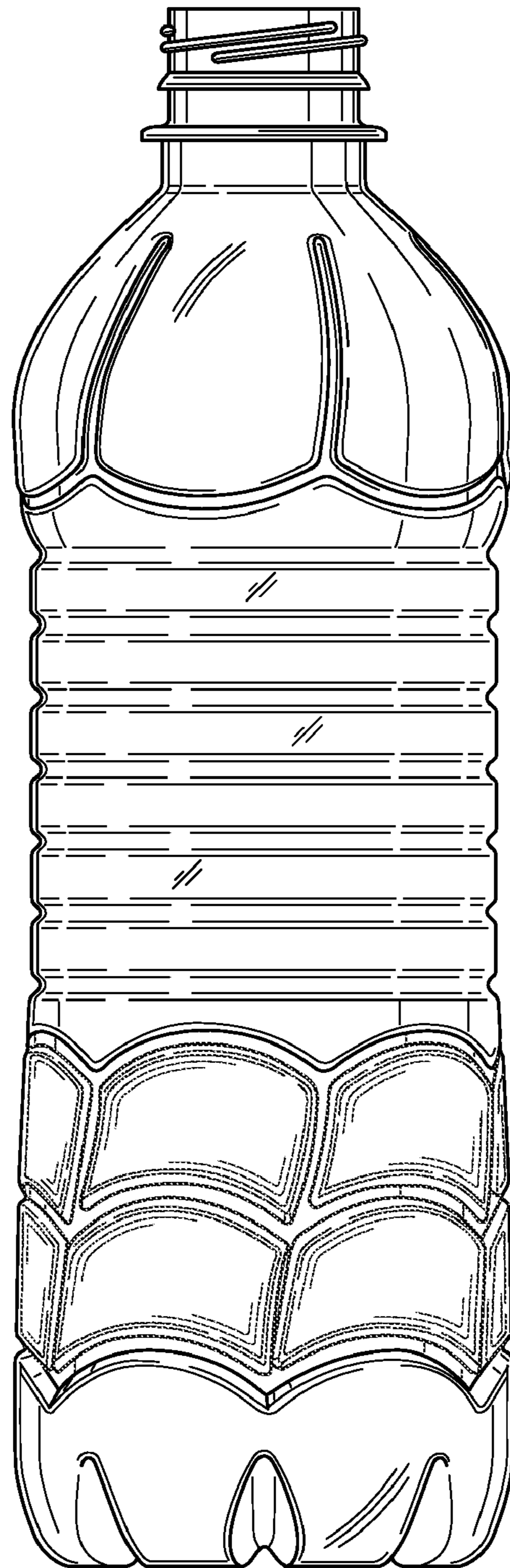

Fig. 12

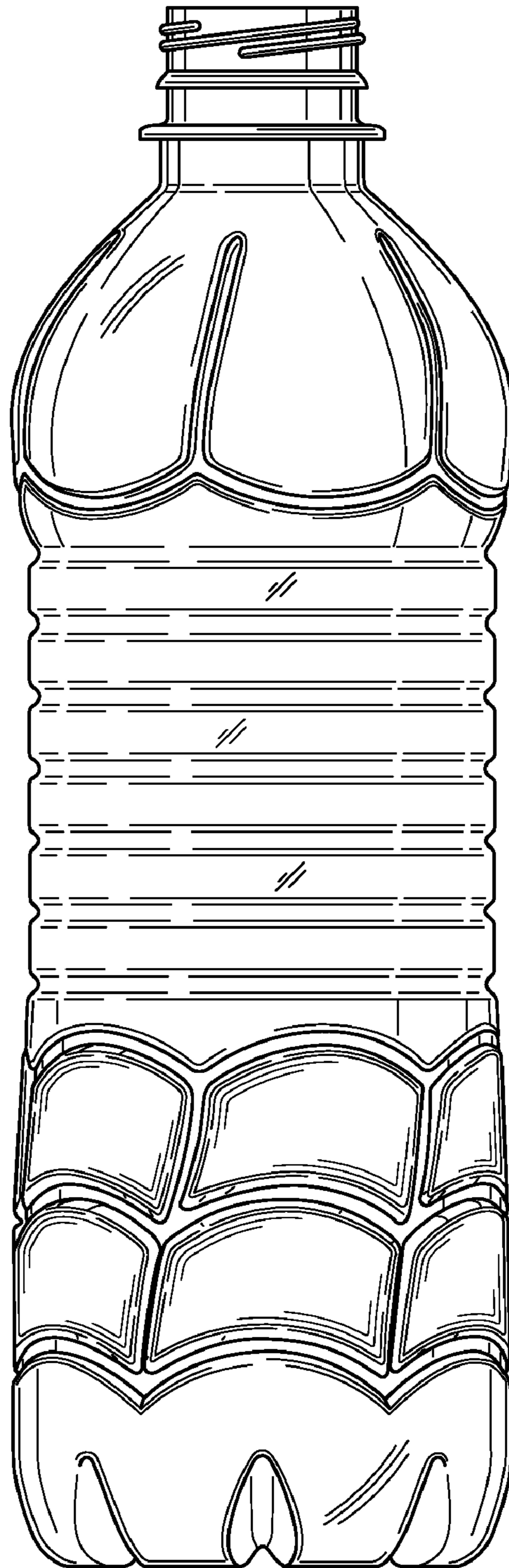

Fig. 13

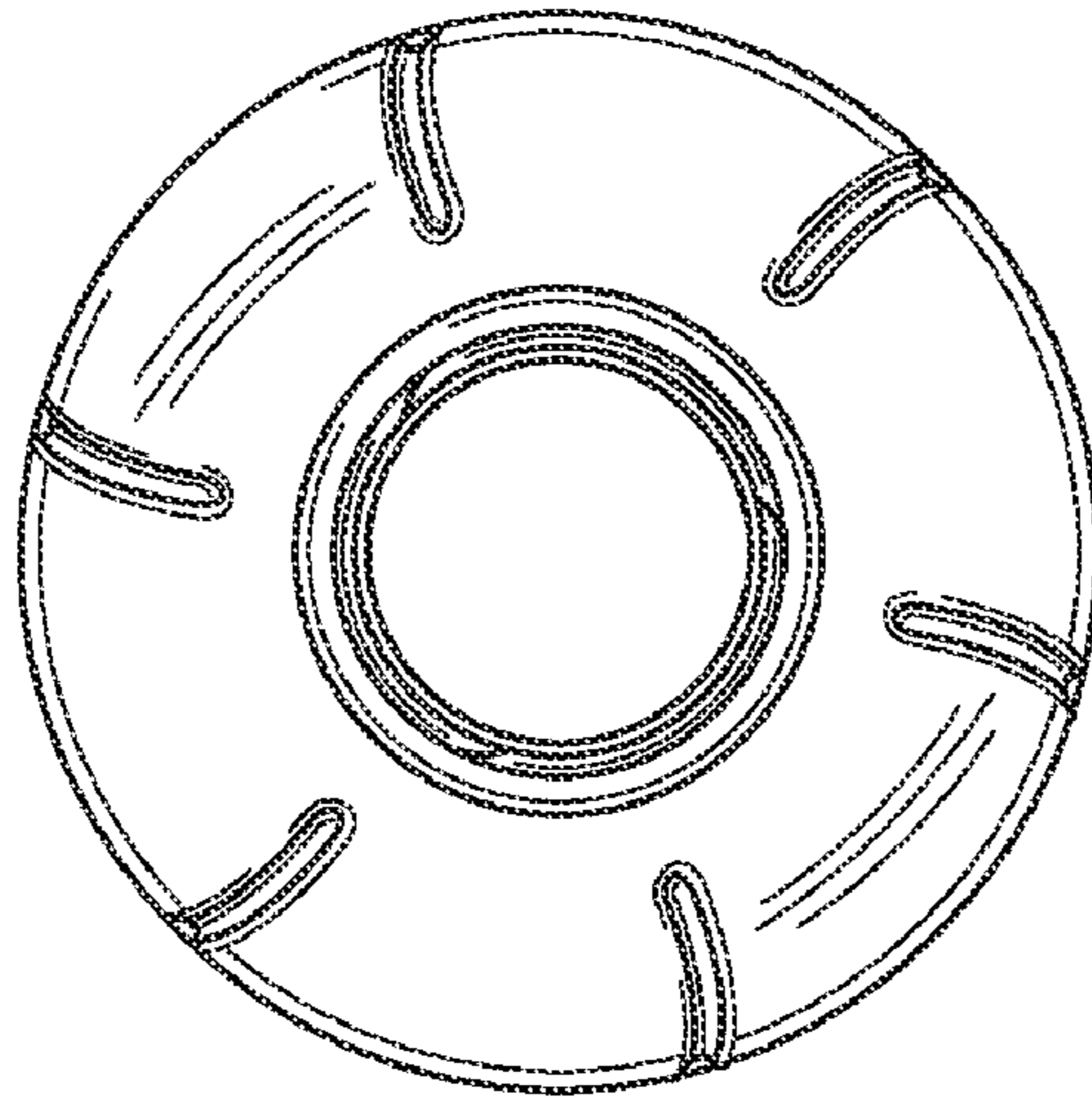

Fig. 14

