



US00D628037S

(12) **United States Design Patent**  
**Klingbeil**

(10) **Patent No.:** **US D628,037 S**

(45) **Date of Patent:** **\*\* Nov. 30, 2010**

(54) **BATTERY-POWERED SCREW GUN**

(75) Inventor: **Thomas Klingbeil**, Bottrop (DE)

(73) Assignee: **Ergobionik GmbH**, Bottrop (DE)

(\*\*) Term: **14 Years**

(21) Appl. No.: **29/293,461**

(22) Filed: **Nov. 26, 2007**

(30) **Foreign Application Priority Data**

May 24, 2007 (EM) ..... 000738687

(51) **LOC (9) Cl.** ..... **08-04**

(52) **U.S. Cl.** ..... **D8/68**

(58) **Field of Classification Search** ..... D8/14.1,  
D8/61, 62, 63, 64, 65, 66, 67, 68, 69, 70;  
81/57.11, 429, 454, 455, 456, 469, 489; 173/13,  
173/104, 114, 168, 169, 170, 171, 178, 201,  
173/211, 213, 217; 408/20, 124, 125, 234,  
408/241 R; 451/358; 310/50; 227/8, 113,  
227/114, 120, 130, 136, 142

See application file for complete search history.

(56) **References Cited**

**U.S. PATENT DOCUMENTS**

- D302,646 S \* 8/1989 Sasaki et al. .... D8/68
- D396,789 S \* 8/1998 Murray ..... D8/68
- D419,413 S \* 1/2000 Heun ..... D8/68
- D420,877 S \* 2/2000 Schultz ..... D8/68
- D485,738 S \* 1/2004 Pretzell ..... D8/69
- 7,111,364 B2 \* 9/2006 Bader et al. .... 173/170
- D530,581 S \* 10/2006 Ino et al. .... D8/69
- D533,421 S \* 12/2006 Aglassinger ..... D8/68
- D546,154 S \* 7/2007 Fong et al. .... D8/68
- D551,527 S \* 9/2007 Aglassinger ..... D8/68

- D558,551 S \* 1/2008 Okuda et al. .... D8/69
- D565,374 S \* 4/2008 Zhang ..... D8/68
- 2003/0094294 A1 \* 5/2003 Fritz ..... 173/171
- 2003/0183049 A1 \* 10/2003 Bader et al. .... 81/489
- 2005/0279197 A1 \* 12/2005 Wottreng et al. .... 81/469
- 2006/0243469 A1 \* 11/2006 Webster ..... 173/217
- 2008/0035361 A1 \* 2/2008 Zhang ..... 173/217
- 2008/0211327 A1 \* 9/2008 Schlegel et al. .... 310/50

**FOREIGN PATENT DOCUMENTS**

GB 3006730 S \* 9/2002

\* cited by examiner

*Primary Examiner*—Robert M Spear

*Assistant Examiner*—Karen Acker

(74) *Attorney, Agent, or Firm*—Berenato & White, LLC

(57) **CLAIM**

The ornamental design for a battery-powered screw gun, as shown and described.

**DESCRIPTION**

FIG. 1 is a perspective view of the left front of the battery-powered screw gun according to the invention;

FIG. 2 is a left-hand side view of the invention, the right-hand side view being a mirror image thereof;

FIG. 3 is a perspective view from above, behind, and to the right of the invention;

FIG. 4 is a front elevational view of the invention;

FIG. 5 is a rear elevational view of the invention;

FIG. 6 is a top view of the invention; and,

FIG. 7 is a bottom view of the invention.

The broken lines in the drawings represent unclaimed environmental subject matter.

**1 Claim, 7 Drawing Sheets**

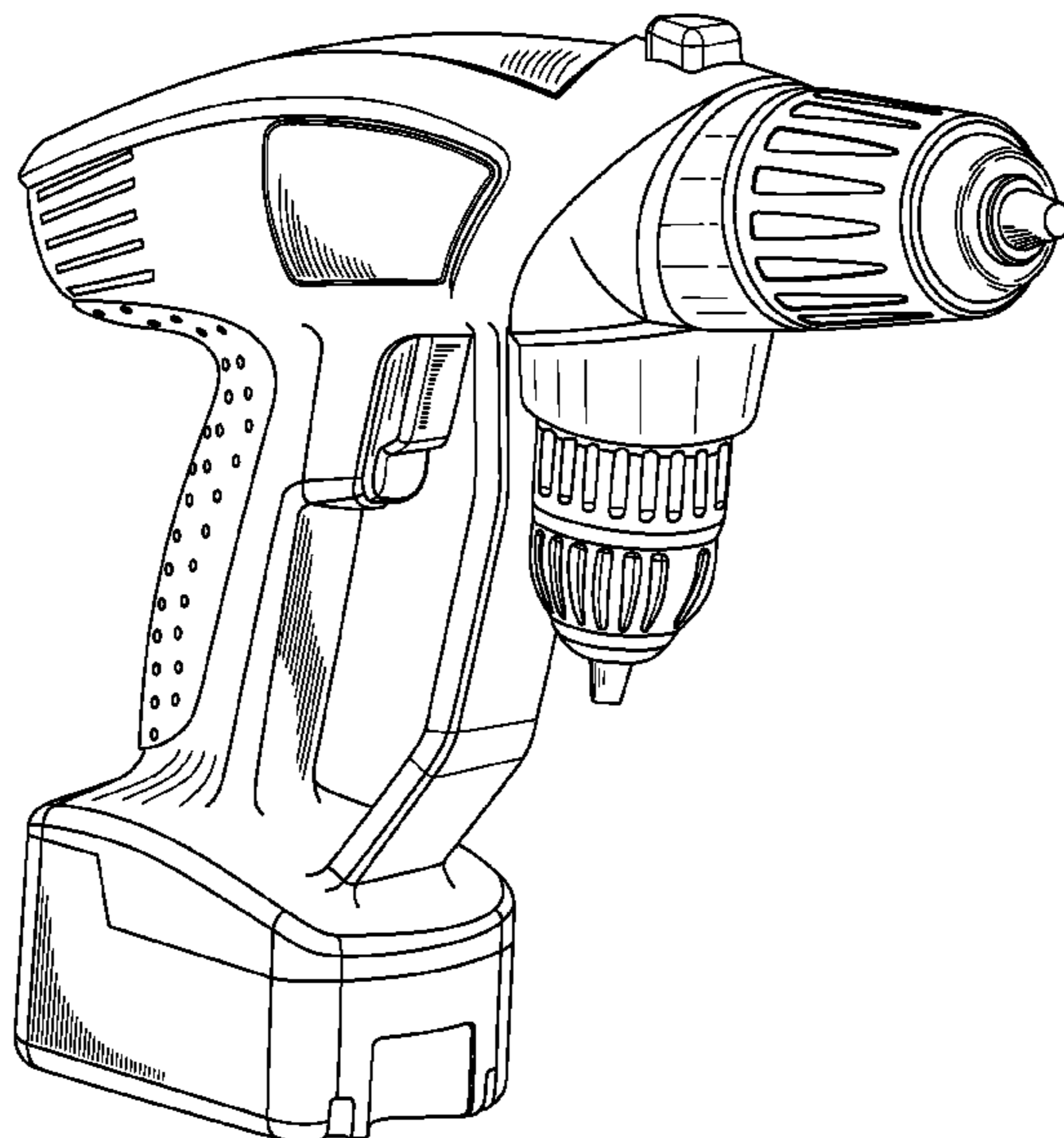

Fig. 1

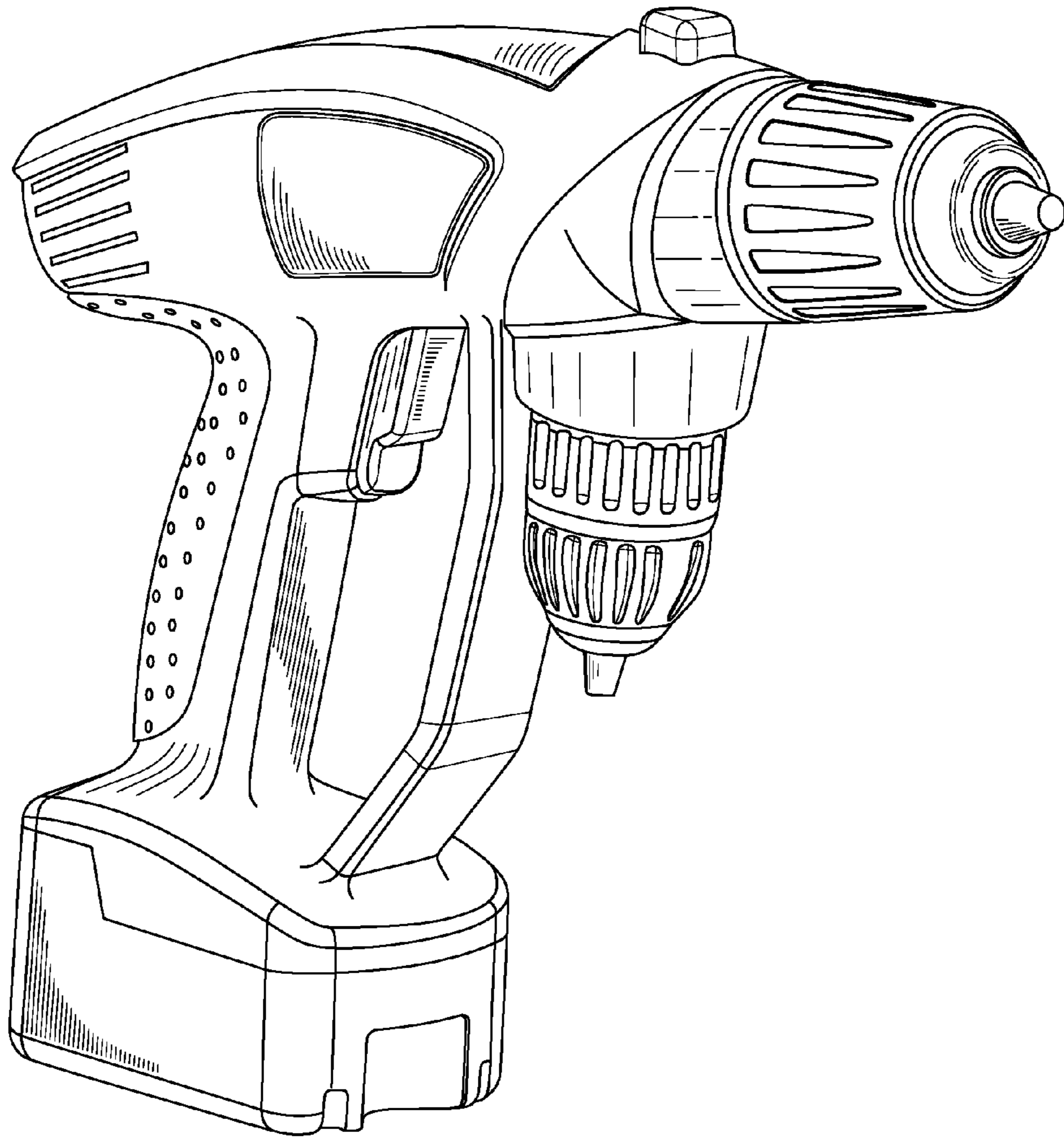

Fig. 2

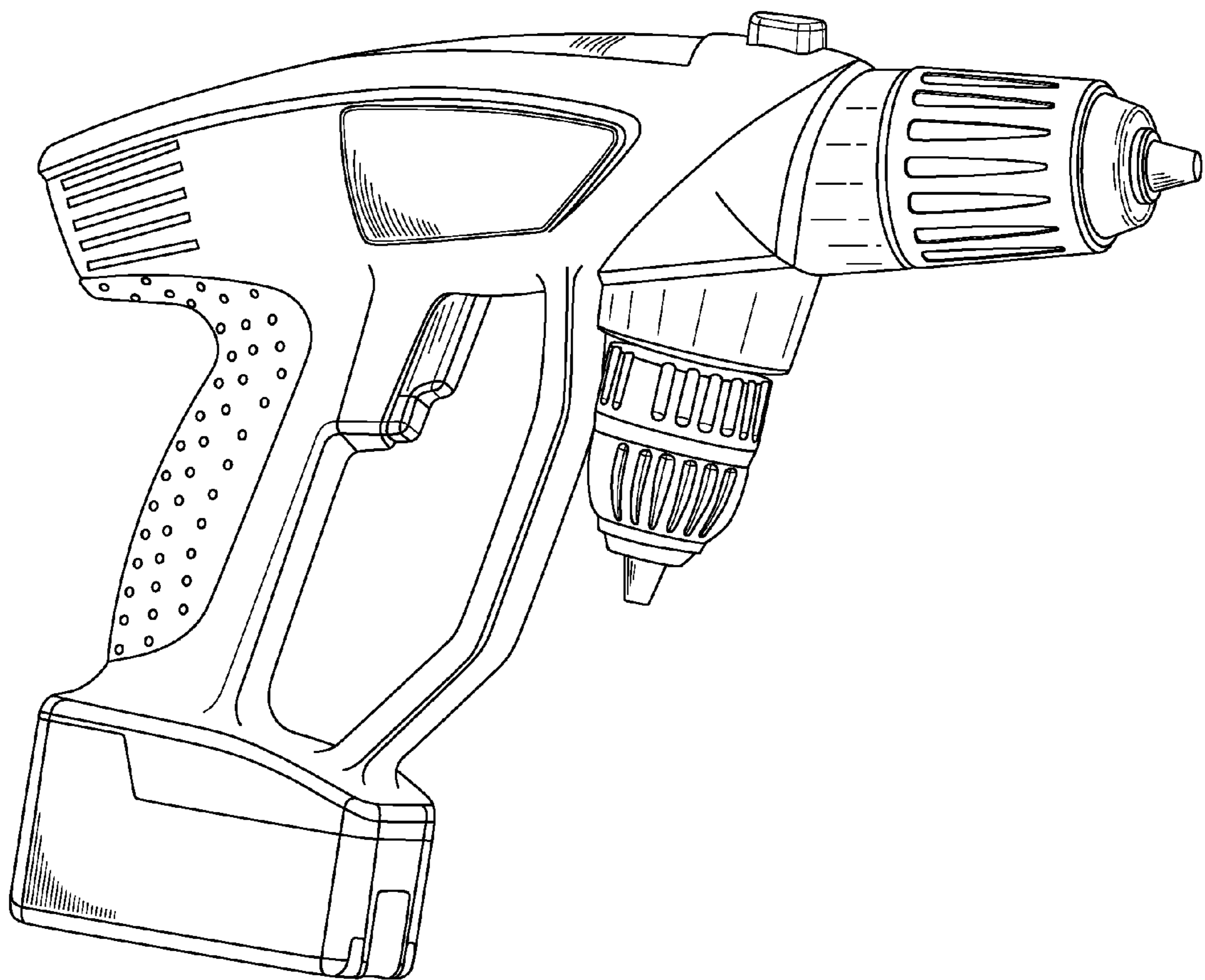

Fig. 3

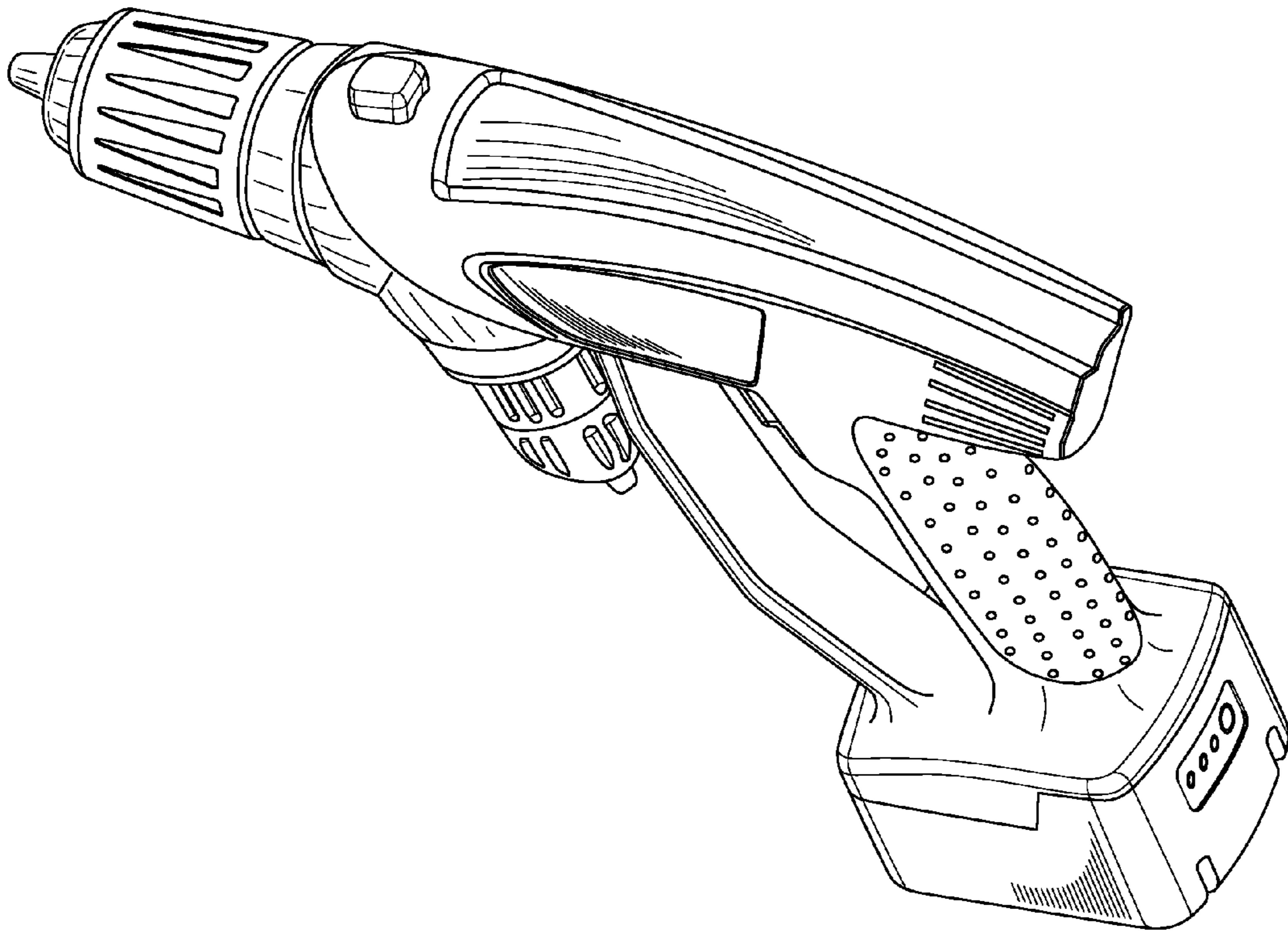

Fig. 4

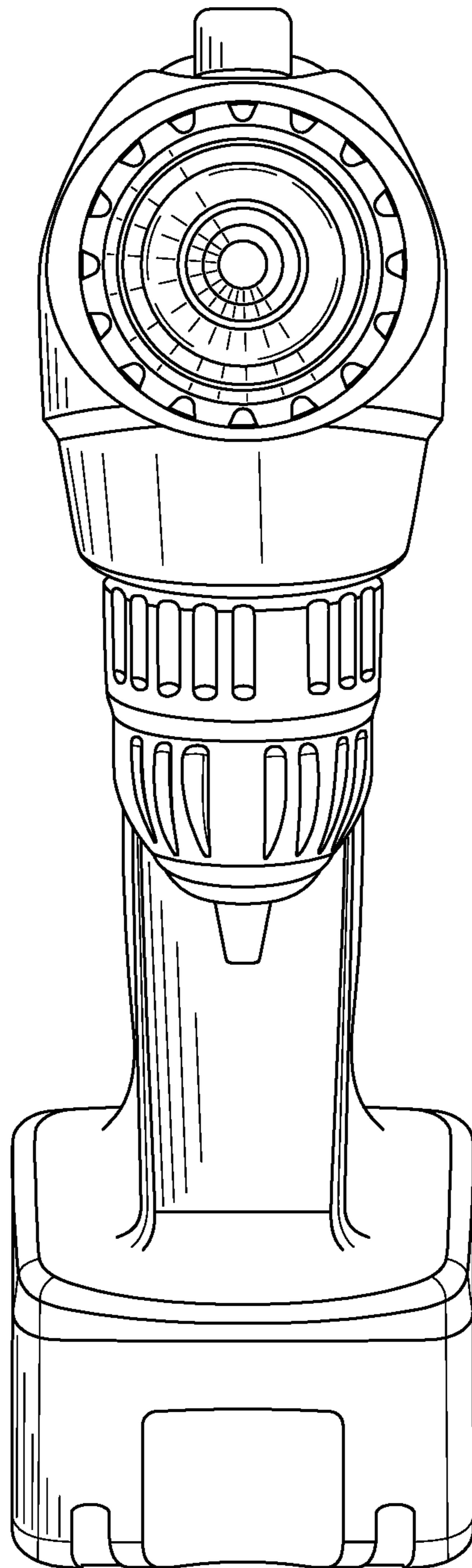

Fig. 5

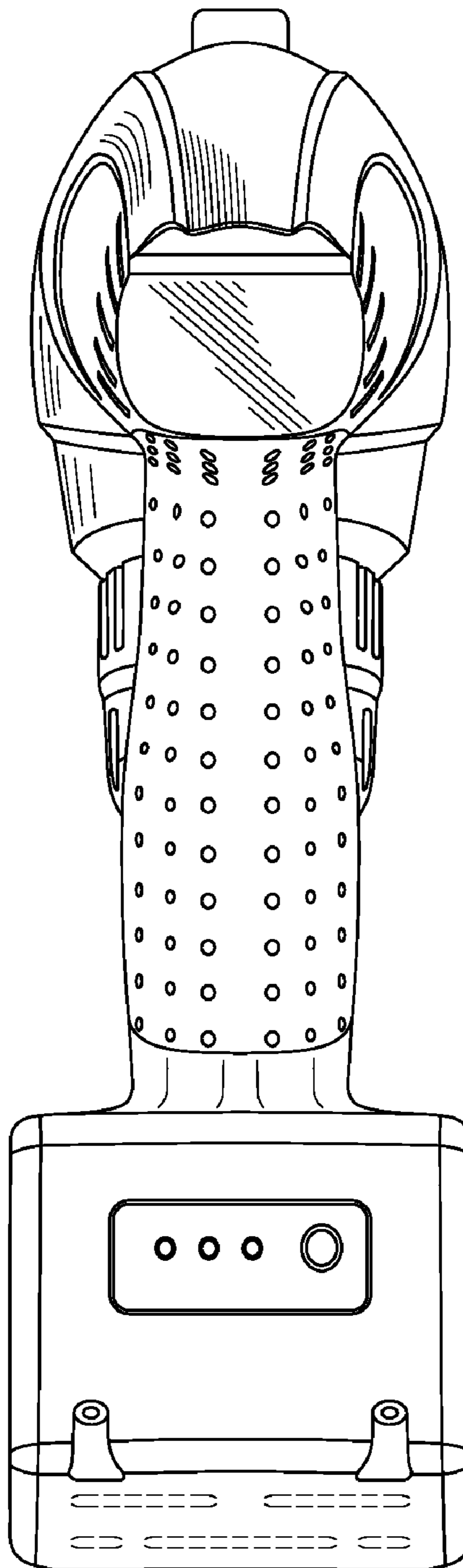

Fig. 6

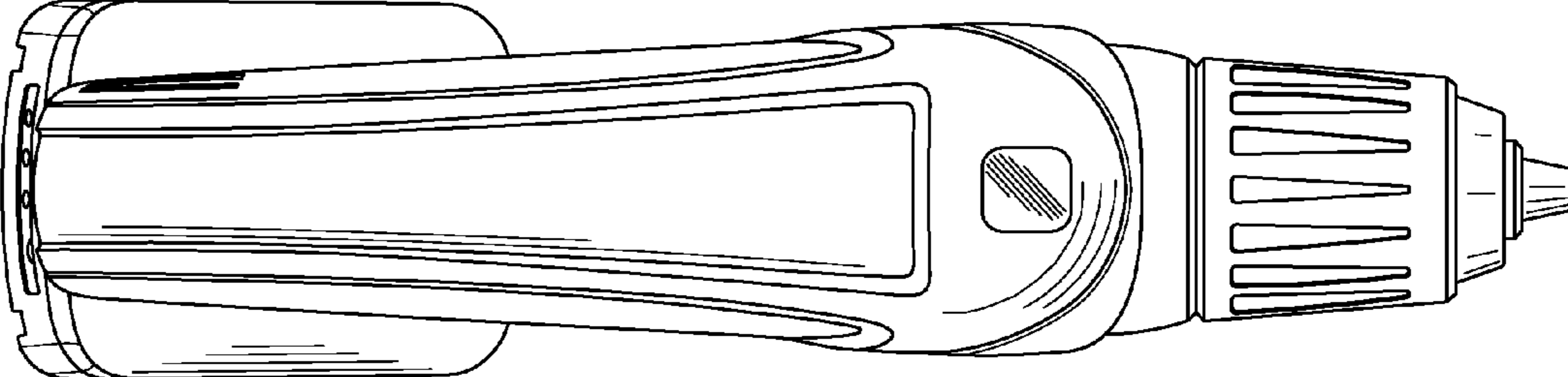

Fig. 7

