



US00D628012S

(12) **United States Design Patent**
Bodum

(10) **Patent No.:** **US D628,012 S**

(45) **Date of Patent:** **** Nov. 30, 2010**

(54) **ELECTRIC MIXER**

D588,865 S * 3/2009 Ferraby D7/380
2005/0007867 A1 * 1/2005 Wanat 366/129

(75) Inventor: **Jorgen Bodum**, Meggen (CH)

* cited by examiner

(73) Assignee: **PI-Design AG**, Triengen (CH)

Primary Examiner—Caron Veynar

(**) Term: **14 Years**

Assistant Examiner—Ricky Pham

(21) Appl. No.: **29/356,441**

(74) *Attorney, Agent, or Firm*—Sughrue Mion, PLLC

(22) Filed: **Feb. 25, 2010**

(57) **CLAIM**

(30) **Foreign Application Priority Data**

The ornamental design for a electric mixer, as shown and described.

Aug. 27, 2009 (WO) DM/072 219

DESCRIPTION

(51) **LOC (9) Cl.** **31-00**

FIG. 1 is a perspective view of a electric mixer showing my new design;

(52) **U.S. Cl.** **D7/379; D7/376**

FIG. 2 is a right side elevation view thereof;

(58) **Field of Classification Search** D7/317–318,
D7/356, 376–386, 412–415, 665; 99/348,
99/509–511; 241/30–37.5, 101.01–101.2,
241/166–169.1, 274–278.2, 285.1–285.3,
241/291, 292.1; 366/64–67, 98, 129, 142,
366/192, 197–211, 203–207, 241–254, 279–292,
366/341–347

FIG. 3 is a left side elevation view thereof;

FIG. 4 is a front elevation view thereof

FIG. 5 is a rear side elevation view thereof;

FIG. 6 is a top view thereof;

FIG. 7 is a bottom view thereof.

FIG. 8 is a close configuration view thereof; and,

FIG. 9 is an open configuration view thereof.

See application file for complete search history.

The broken lines depict environmental subject matter only and form no part of the claimed design.

(56) **References Cited**

U.S. PATENT DOCUMENTS

D204,408 S * 4/1966 Fischer D7/386
D336,405 S * 6/1993 Maass D7/379
D337,667 S * 7/1993 Lovett D7/379

1 Claim, 9 Drawing Sheets

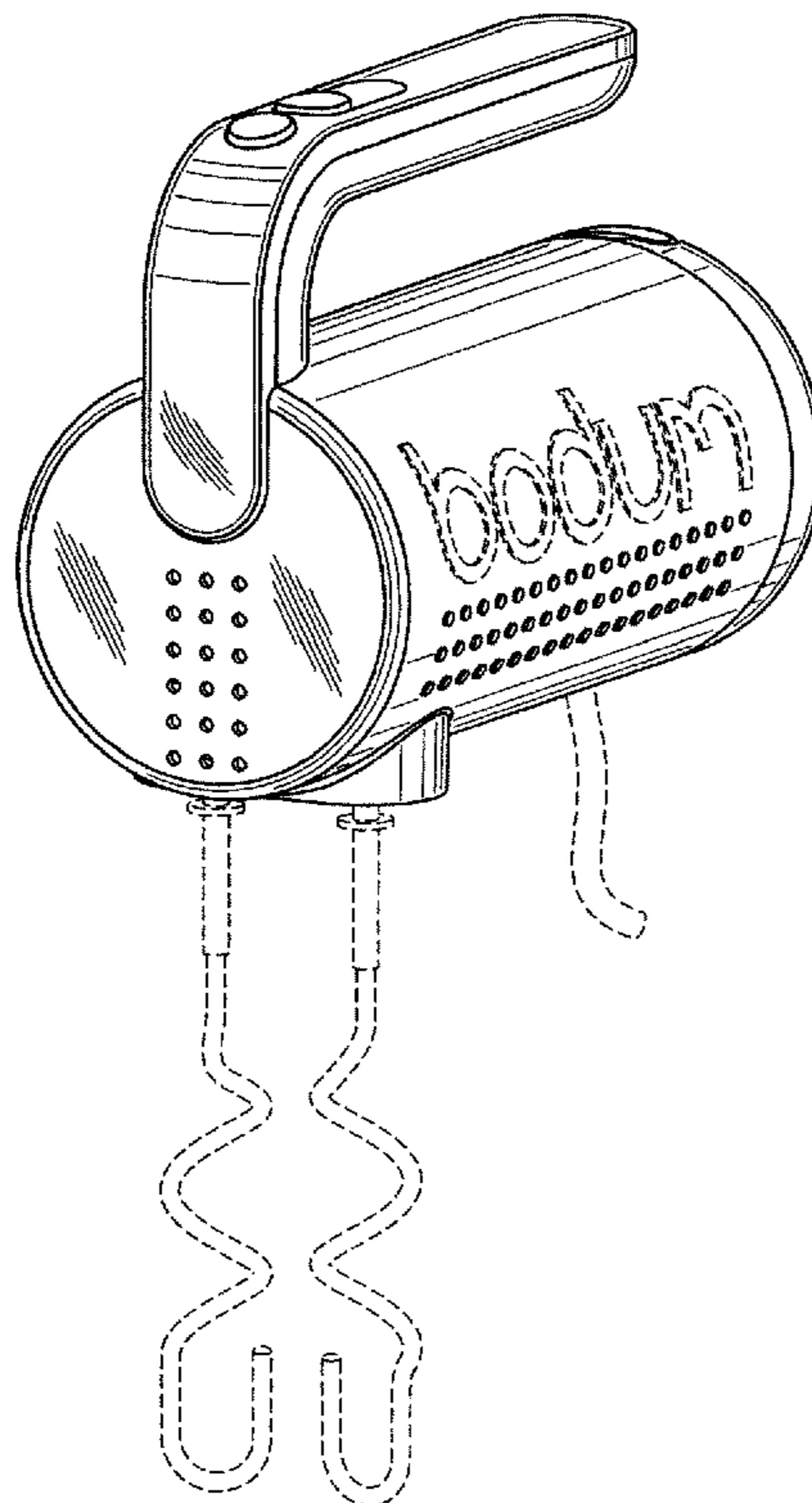

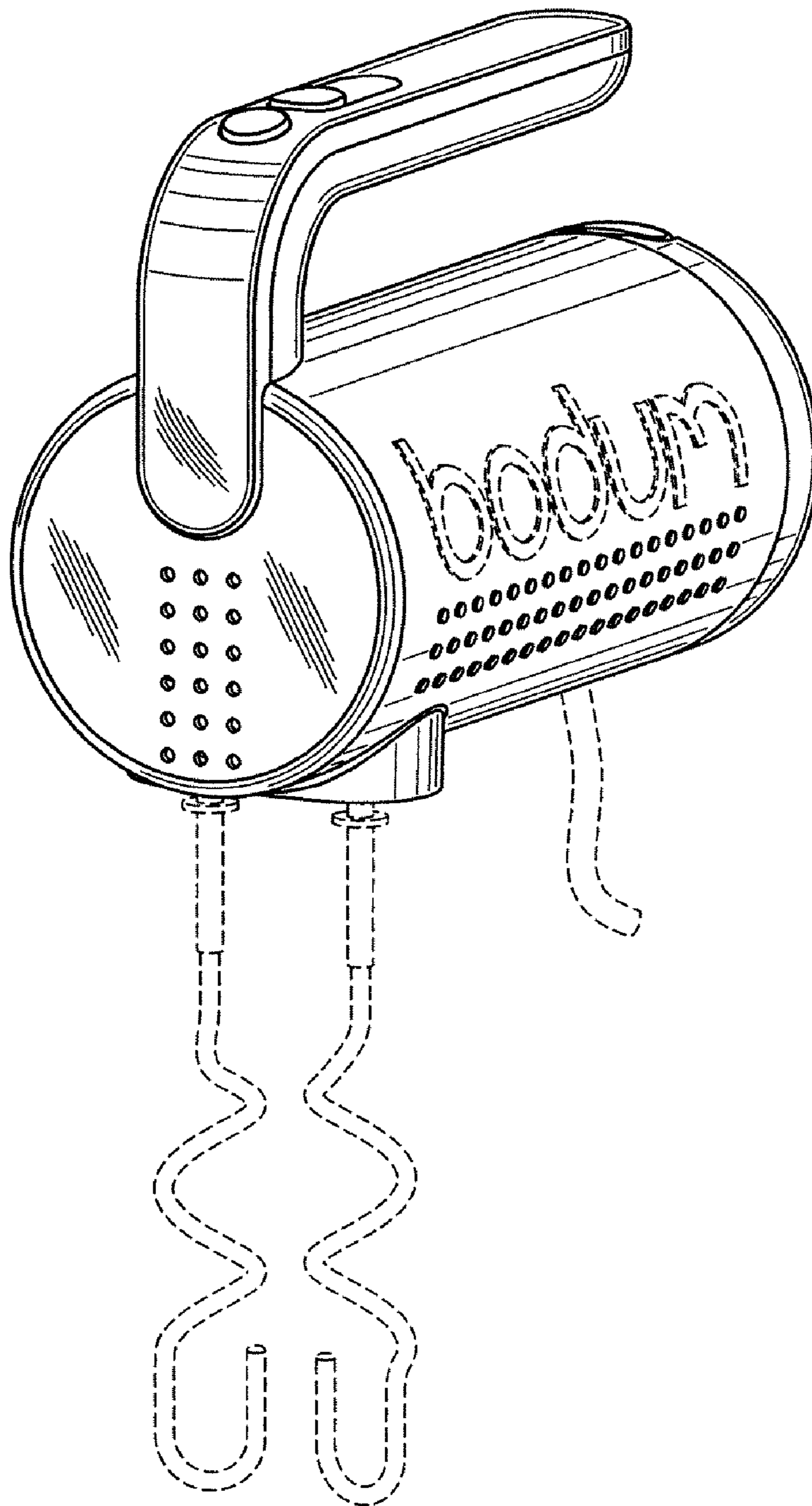

FIG. 1

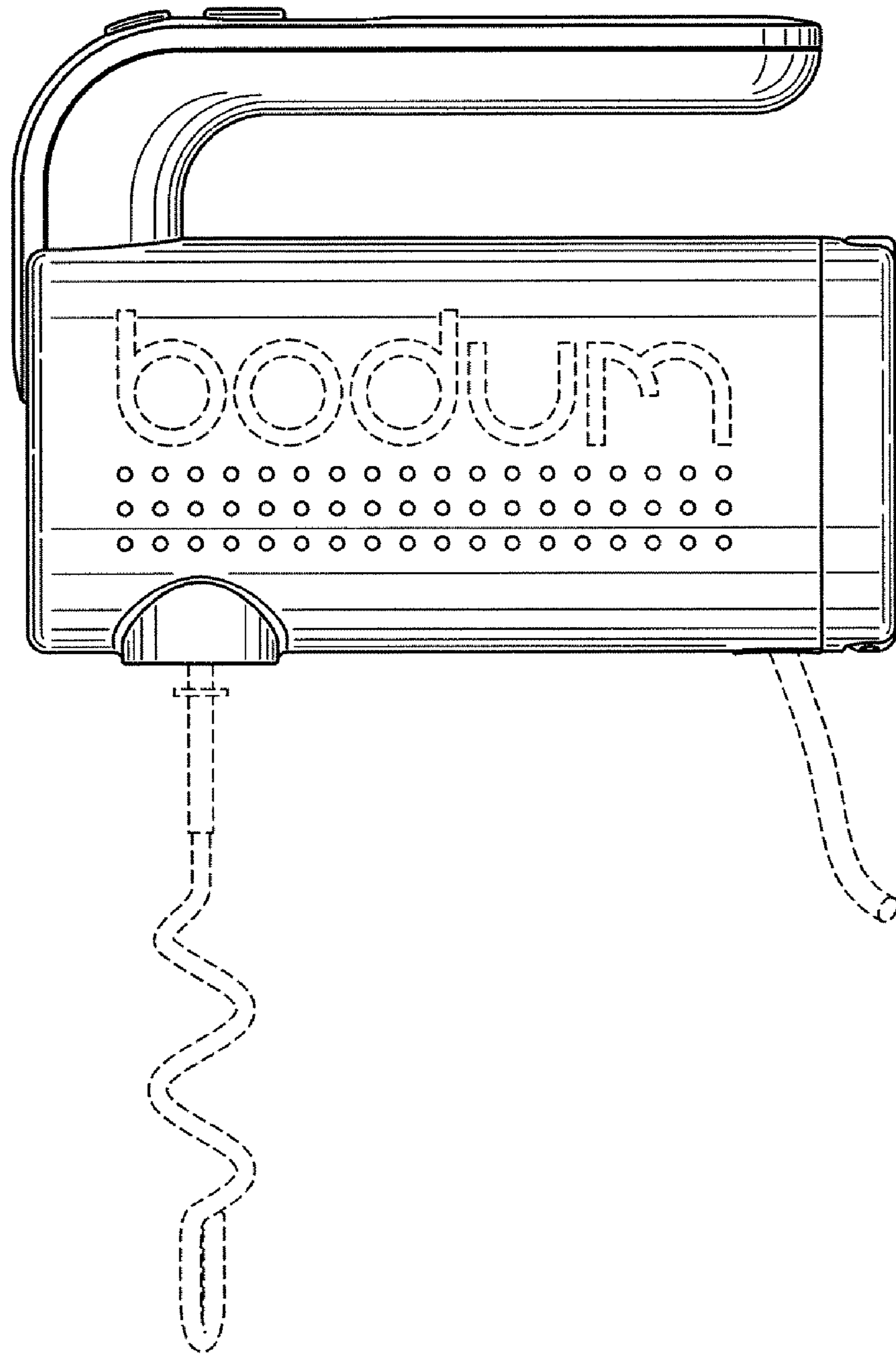

FIG. 2

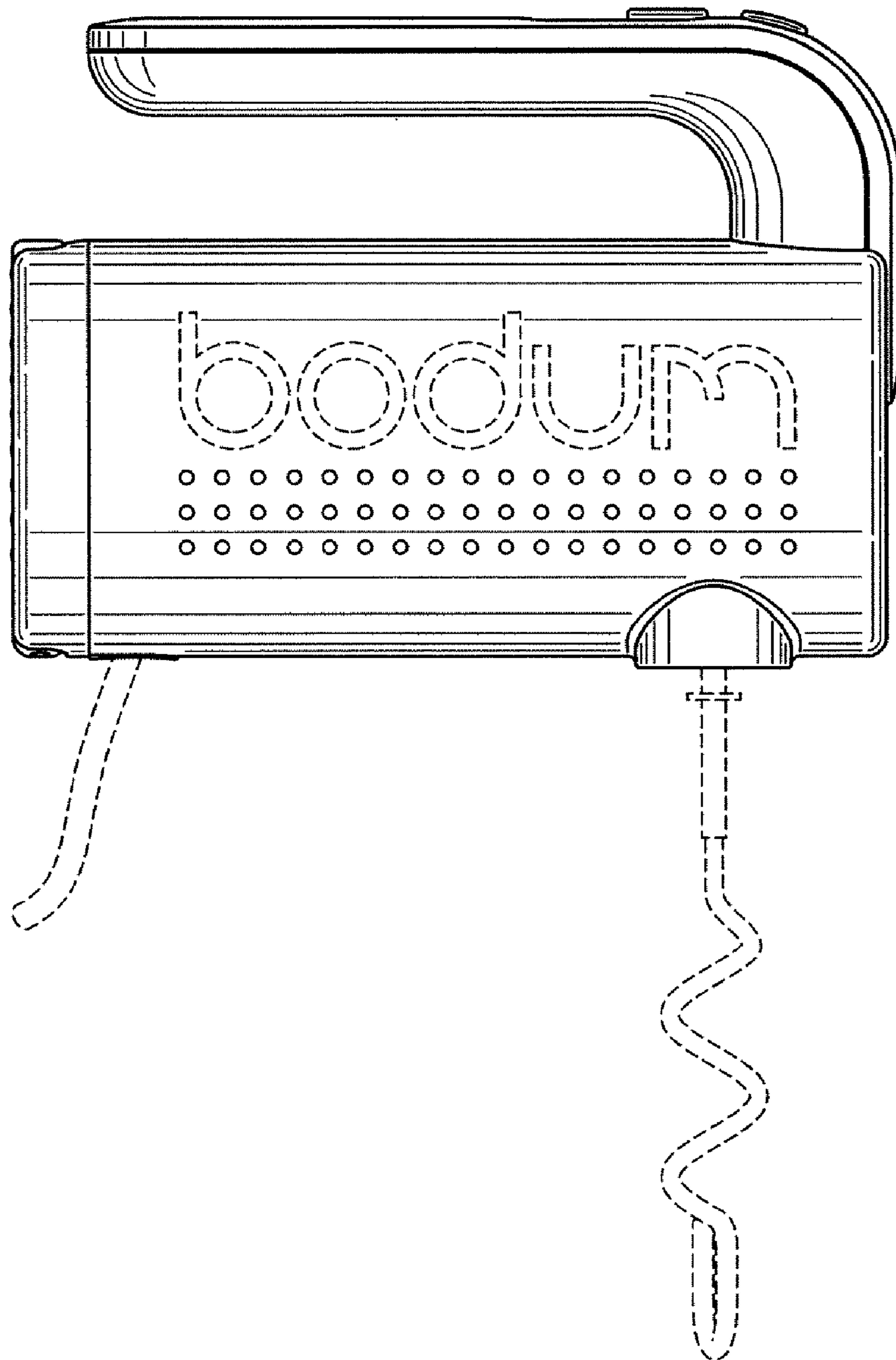

FIG. 3

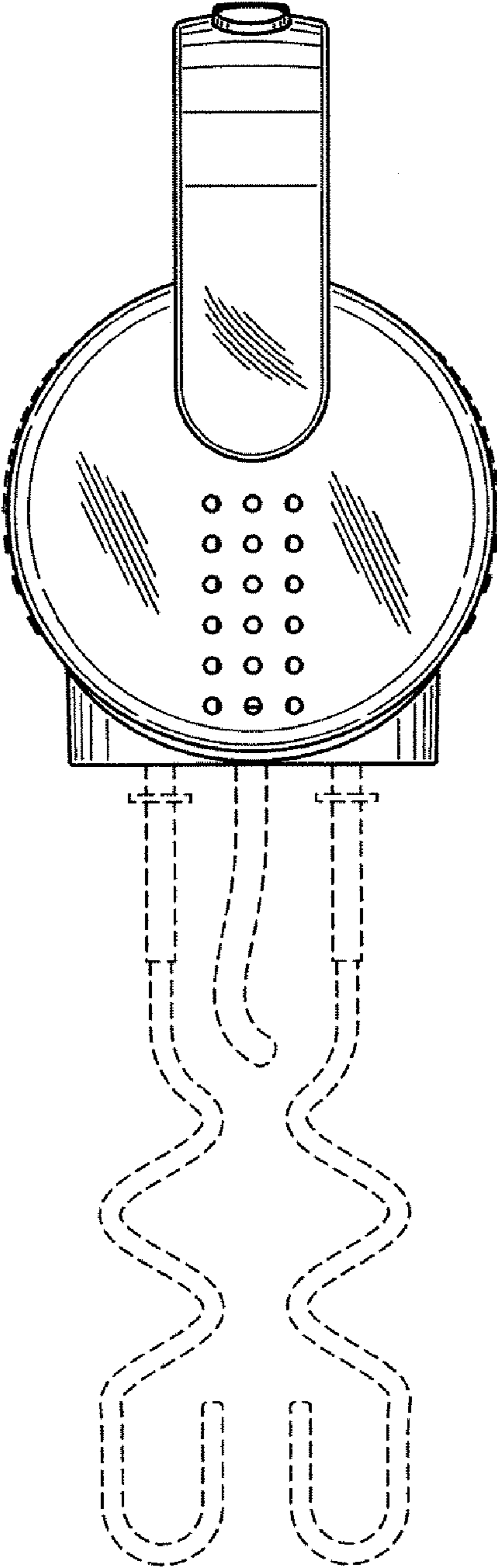

FIG. 4

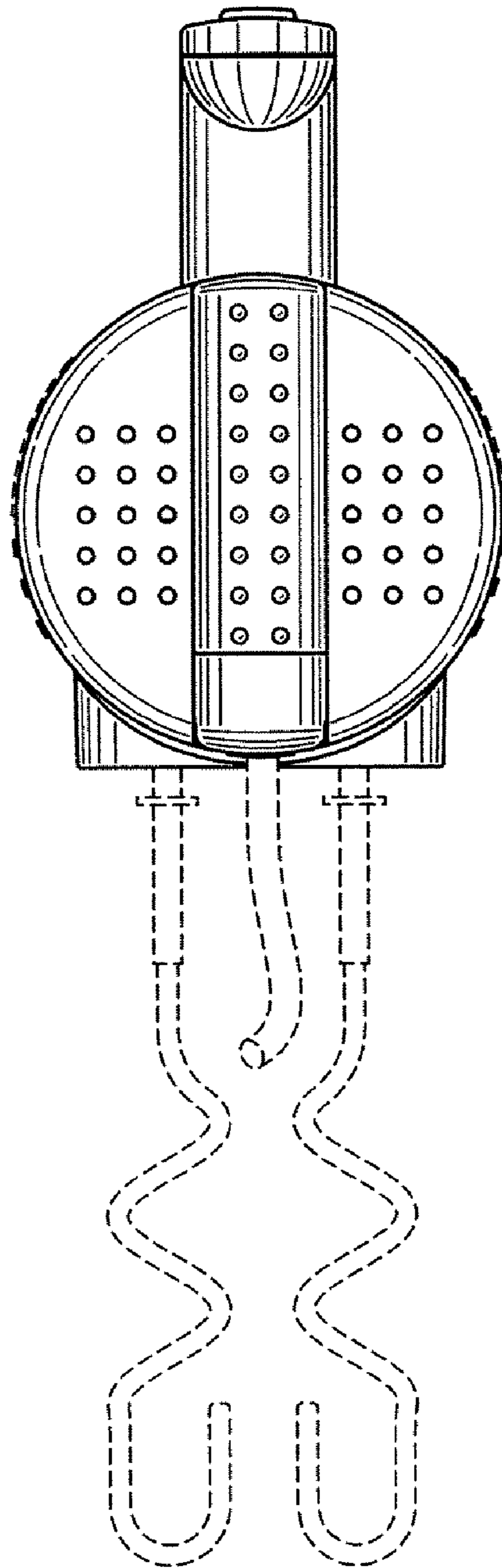

FIG. 5

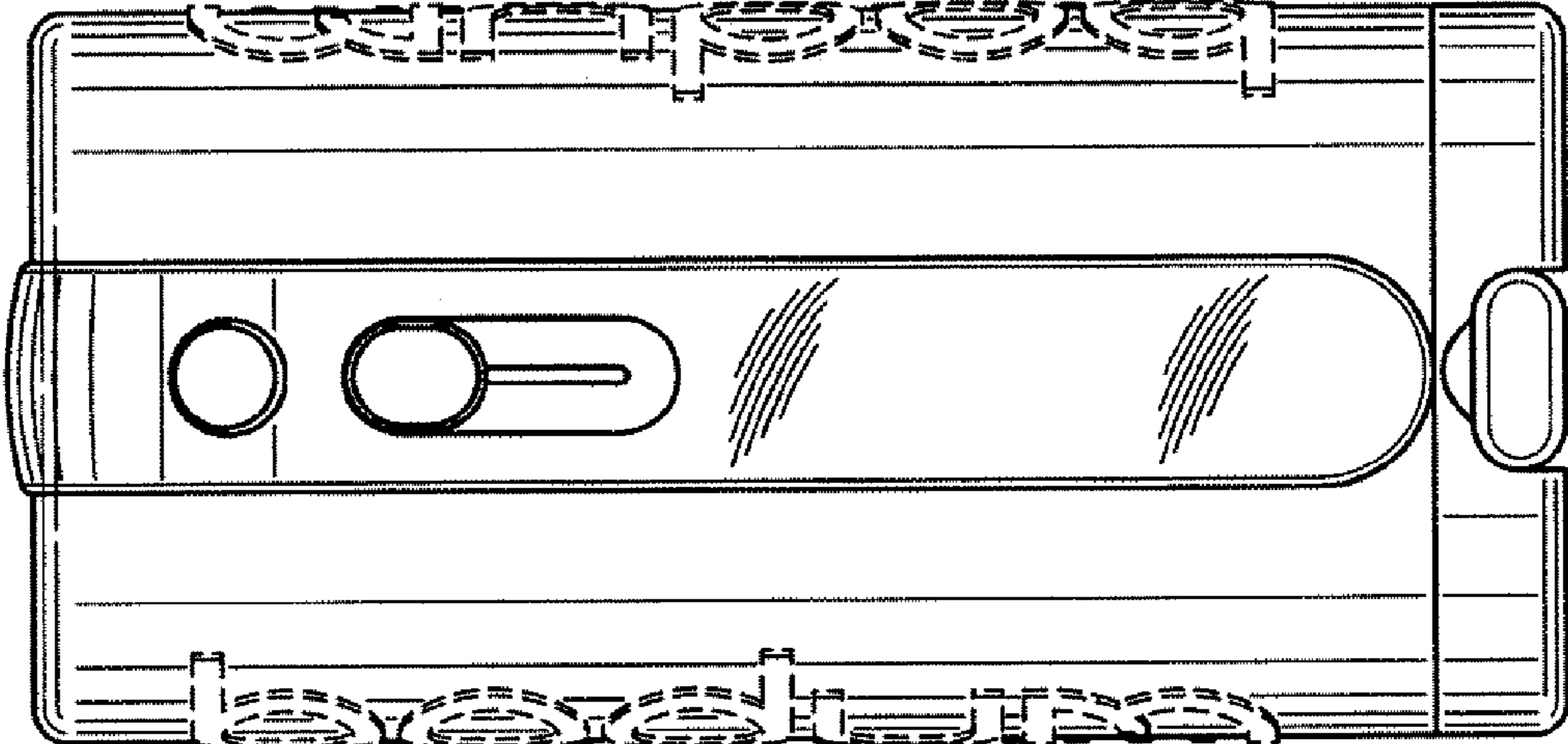

FIG. 6

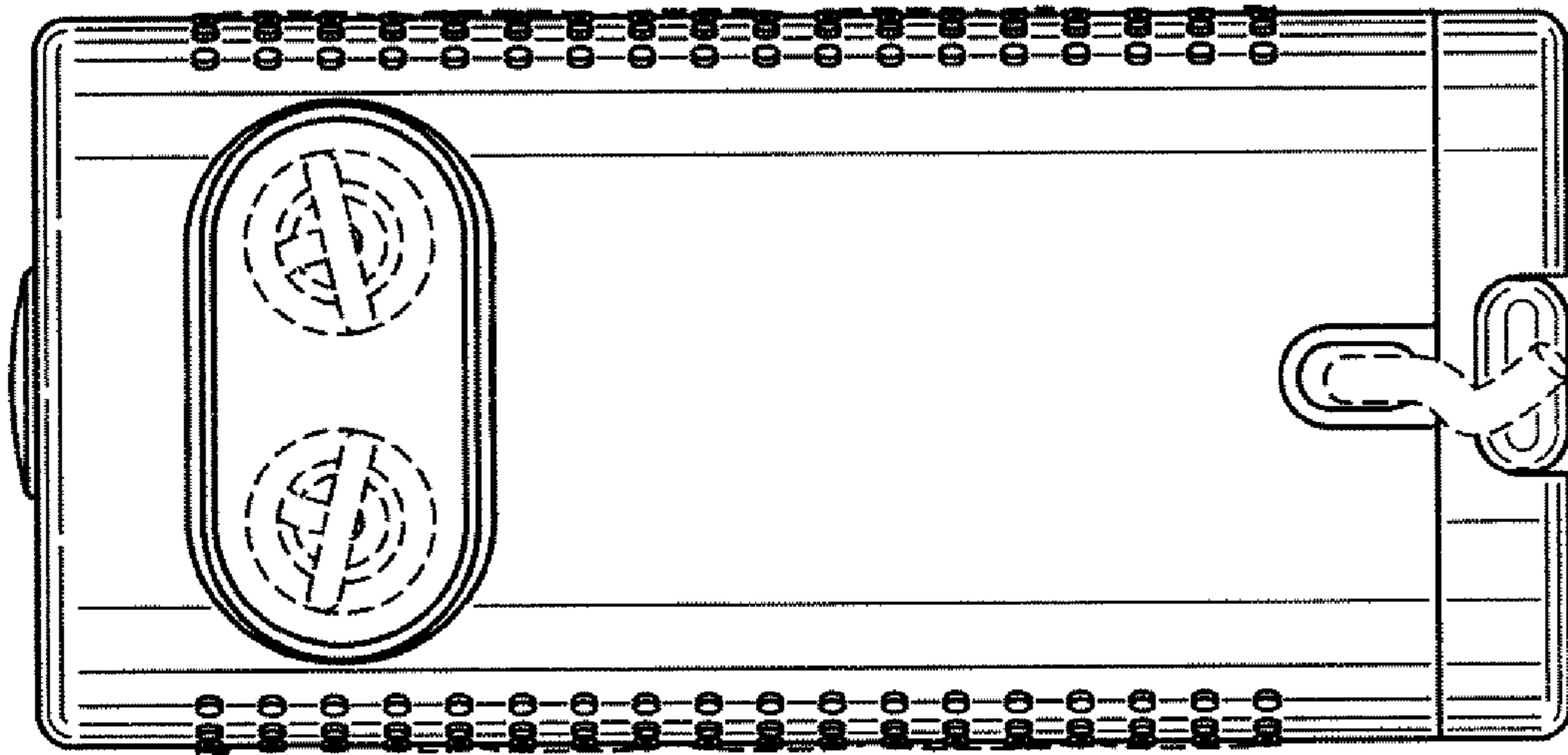

FIG. 7

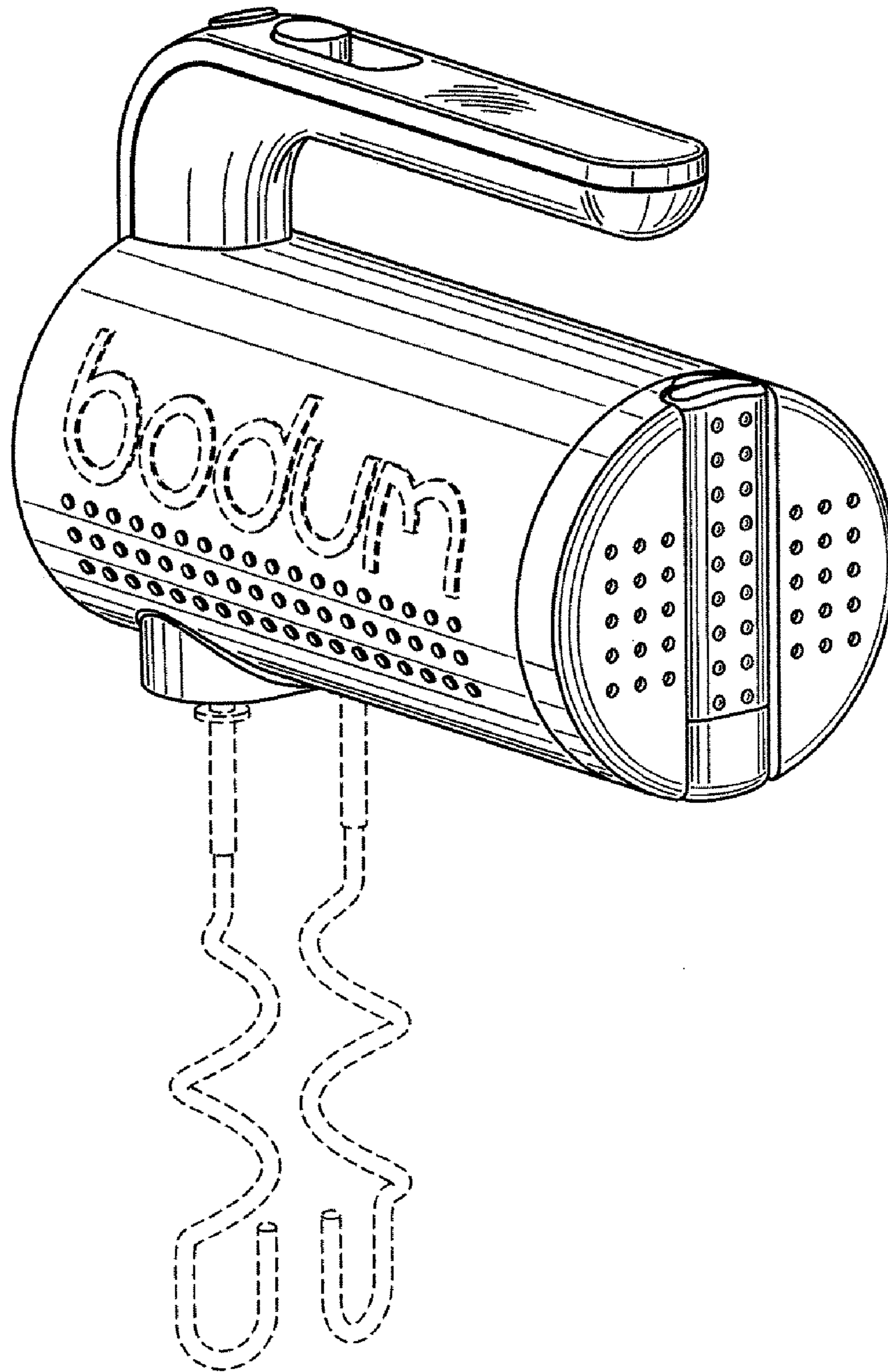

FIG. 8

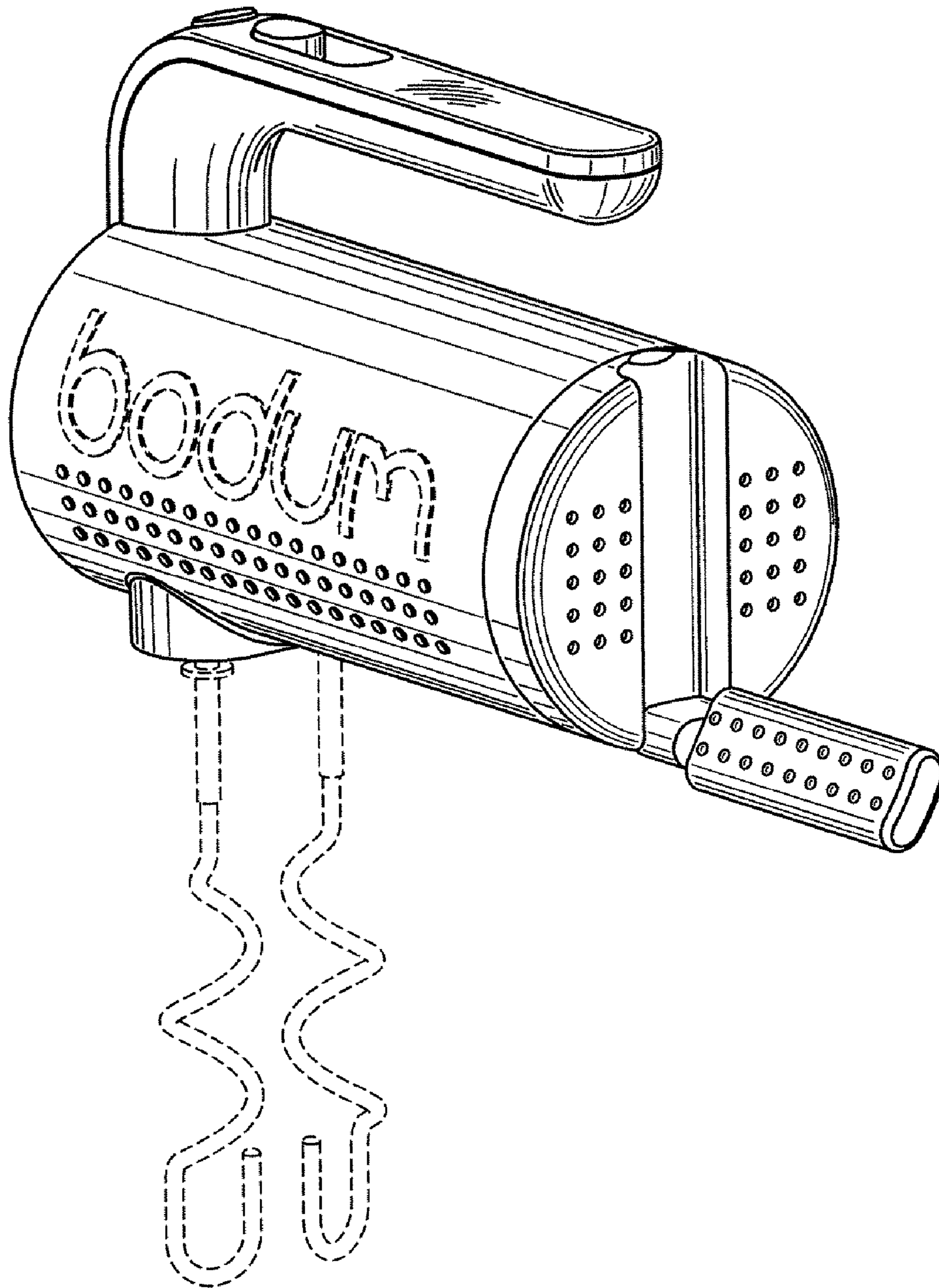

FIG. 9