



US00D627934S

(12) **United States Design Patent**
Willinger et al.

(10) **Patent No.:** **US D627,934 S**
(45) **Date of Patent:** **** Nov. 23, 2010**

(54) **BIRD TOY**

(75) Inventors: **Jonathan Willinger**, Tenefly, NJ (US);
Peter Ragonetti, Brooklyn, NY (US)

(73) Assignee: **J.W. Pet Company, Inc.**, Teterboro, NJ
(US)

(**) Term: **14 Years**

(21) Appl. No.: **29/356,921**

(22) Filed: **Mar. 4, 2010**

Related U.S. Application Data

(63) Continuation of application No. 29/318,148, filed on
May 14, 2008.

(51) **LOC (9) Cl.** **30-02**

(52) **U.S. Cl.** **D30/119; D30/160**

(58) **Field of Classification Search** D30/119,
D30/160; D21/405-407, 465, 467, 474-476;
40/613; 119/702, 706-711; 446/227
See application file for complete search history.

(56) **References Cited**

U.S. PATENT DOCUMENTS

D20,484 S *	1/1891	Herrick	D21/405
887,740 A	5/1908	Phillips		
1,141,434 A *	6/1915	Tosta	D21/467
D174,580 S	4/1955	Kiehl		
2,707,937 A *	5/1955	Herman	119/708
D175,292 S *	8/1955	Austgen	D30/160
3,049,863 A	8/1962	Ranney		
D207,605 S *	5/1967	Van	D21/405
3,584,400 A	6/1971	Voges		
D233,770 S *	11/1974	Clark et al.	D30/160
4,756,109 A *	7/1988	Marcus	40/613
5,008,867 A	4/1991	Ko		
5,116,255 A	5/1992	Keeling et al.		
D337,393 S *	7/1993	Weldy	D30/119
5,339,770 A *	8/1994	Haffner	119/708
5,370,570 A *	12/1994	Harris	446/227
5,924,908 A	7/1999	O'Heir		
D414,717 S	10/1999	Comero et al.		

D423,738 S *	4/2000	Carlson	D30/160
D434,325 S	11/2000	Jivago		
6,447,362 B2 *	9/2002	Khamphilavong et al.	..	446/227
6,505,438 B1	1/2003	Hsia		
D473,979 S *	4/2003	Schwartz et al.	D30/160
D478,194 S *	8/2003	McGinty	D30/160
6,603,709 B2	8/2003	Ochoa Loaiza		
6,827,040 B1 *	12/2004	McGinn et al.	119/706
6,834,025 B1	12/2004	Loaiza		
6,848,396 B2 *	2/2005	Carleson et al.	119/702
D505,589 S	5/2005	Hoff et al.		
D528,169 S *	9/2006	Hayes	D21/467
D530,866 S	10/2006	Woltmann et al.		
D545,902 S	7/2007	Keith		
D554,298 S *	10/2007	Woltmann et al.	D30/119
D554,299 S	10/2007	Ragnetti et al.		
2003/0106248 A1 *	6/2003	Chang	40/554

OTHER PUBLICATIONS

U.S. Office Action dated Dec. 4, 2009 for U.S. Appl. No. 29/318,148.
U.S. Office Action dated Aug. 3, 2009 for U.S. Appl. No. 29/318,148.

* cited by examiner

Primary Examiner—Cathy Anne MacCormac
(74) *Attorney, Agent, or Firm*—Katten Muchin Rosenman
LLP

(57) **CLAIM**

The ornamental design for bird toy, as shown and described.

DESCRIPTION

FIG. 1 is a perspective view of a bird toy;
FIG. 2 is a front view thereof;
FIG. 3 is a rear view thereof;
FIG. 4 is a left side view thereof;
FIG. 5 is a right side view thereof;
FIG. 6 is a top view thereof; and,
FIG. 7 is a bottom view thereof.

The portions of the designs that are shown in broken lines do
not form part of the claimed design.

1 Claim, 6 Drawing Sheets

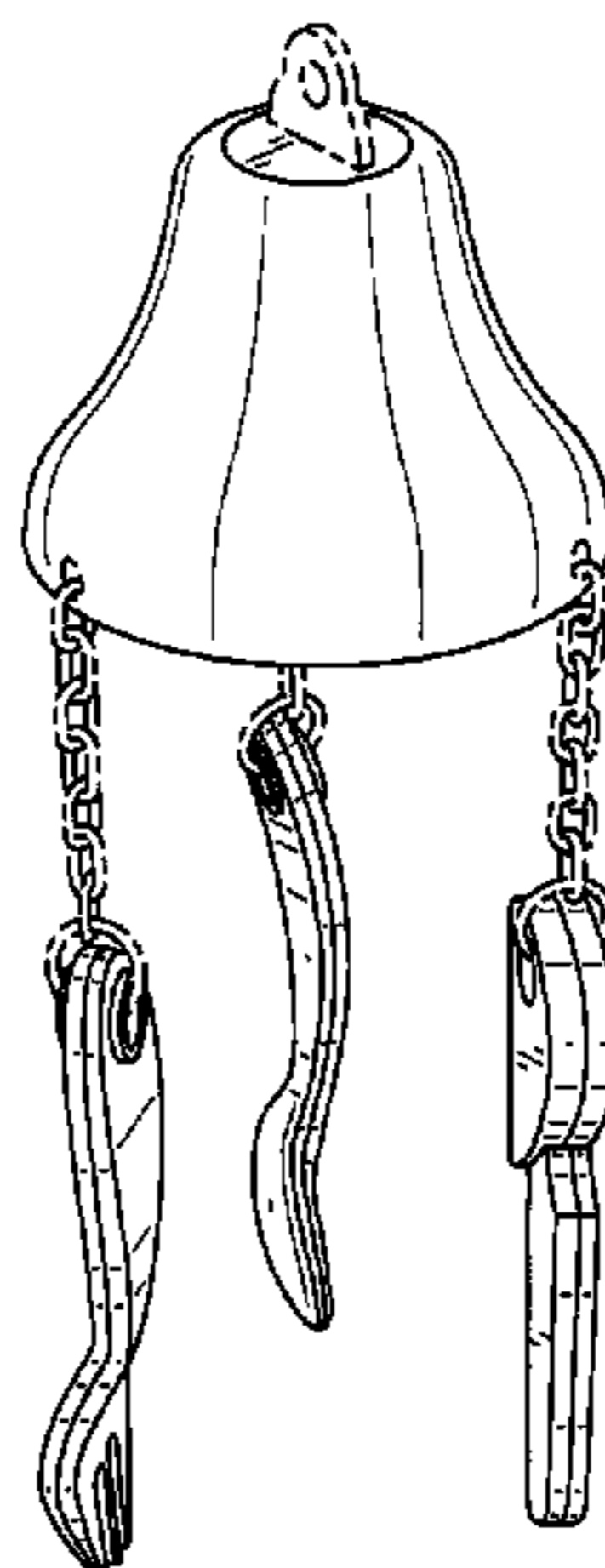

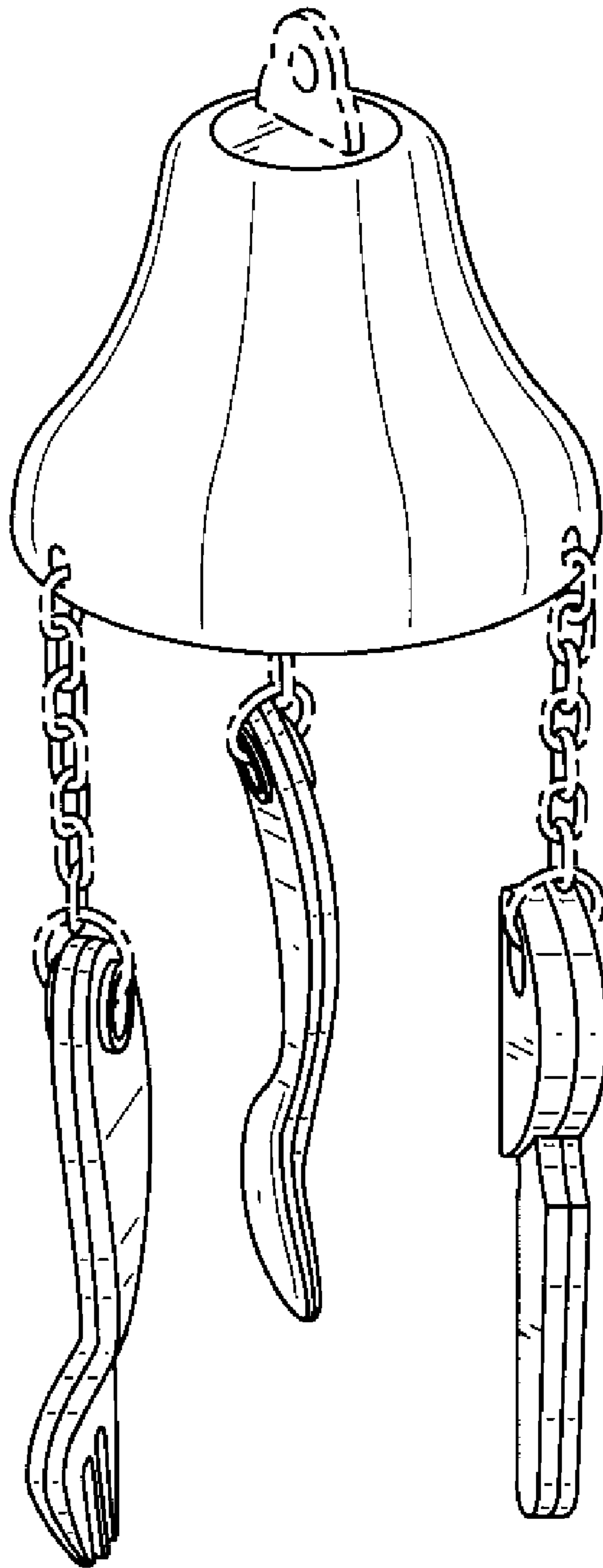

FIG. 1

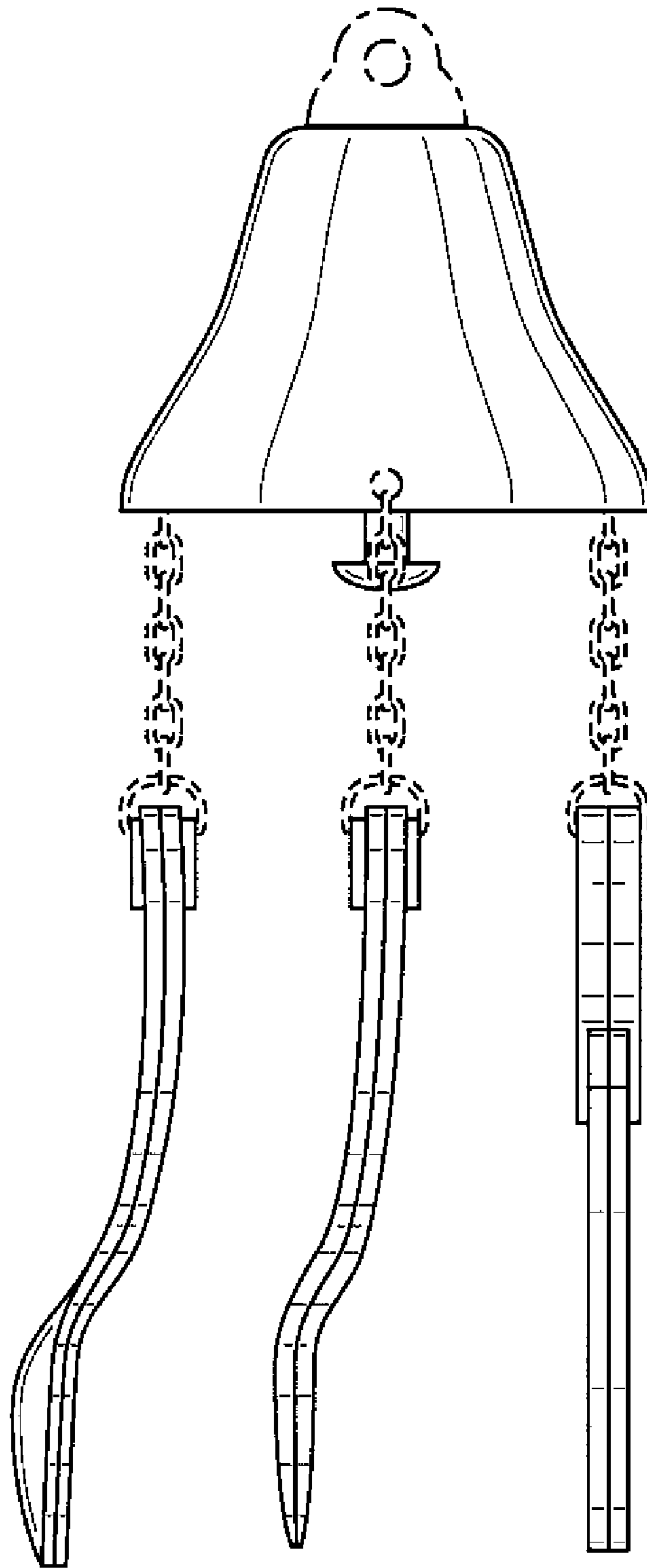

FIG. 2

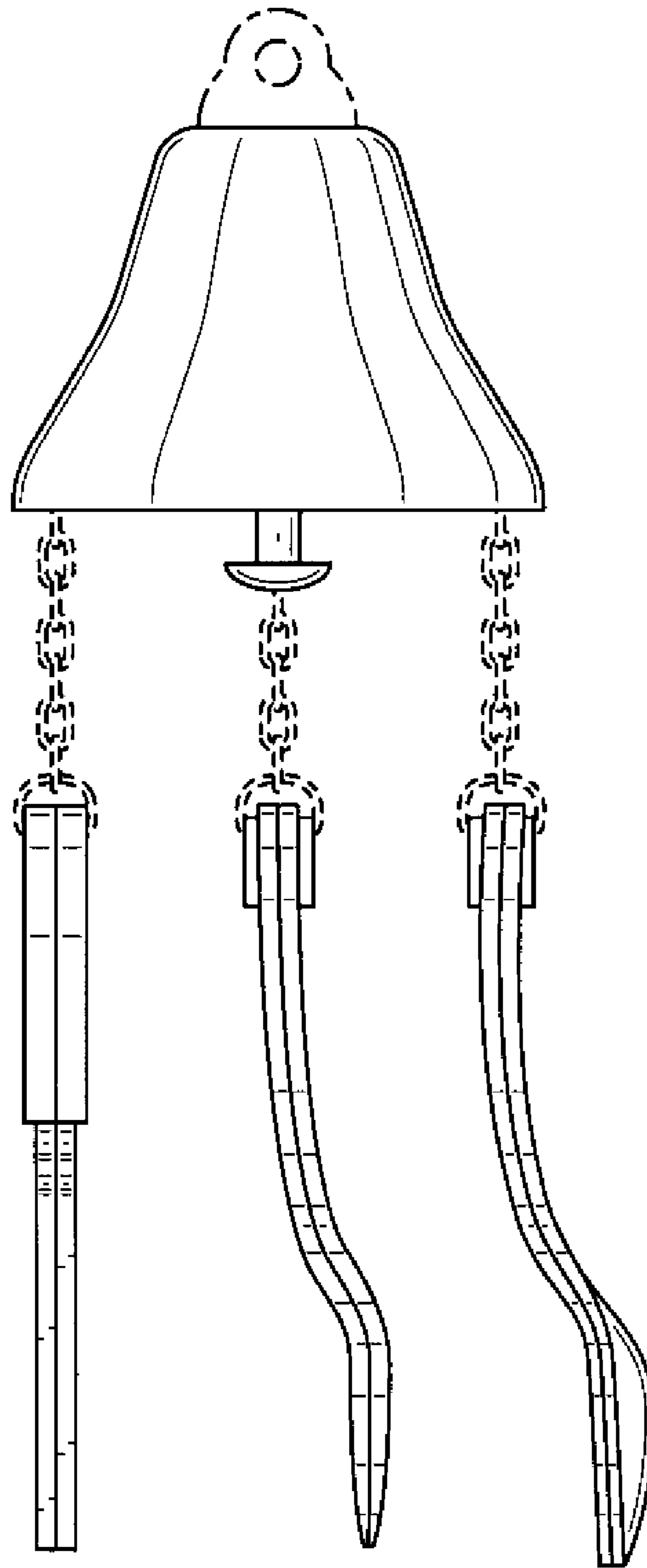

FIG. 3

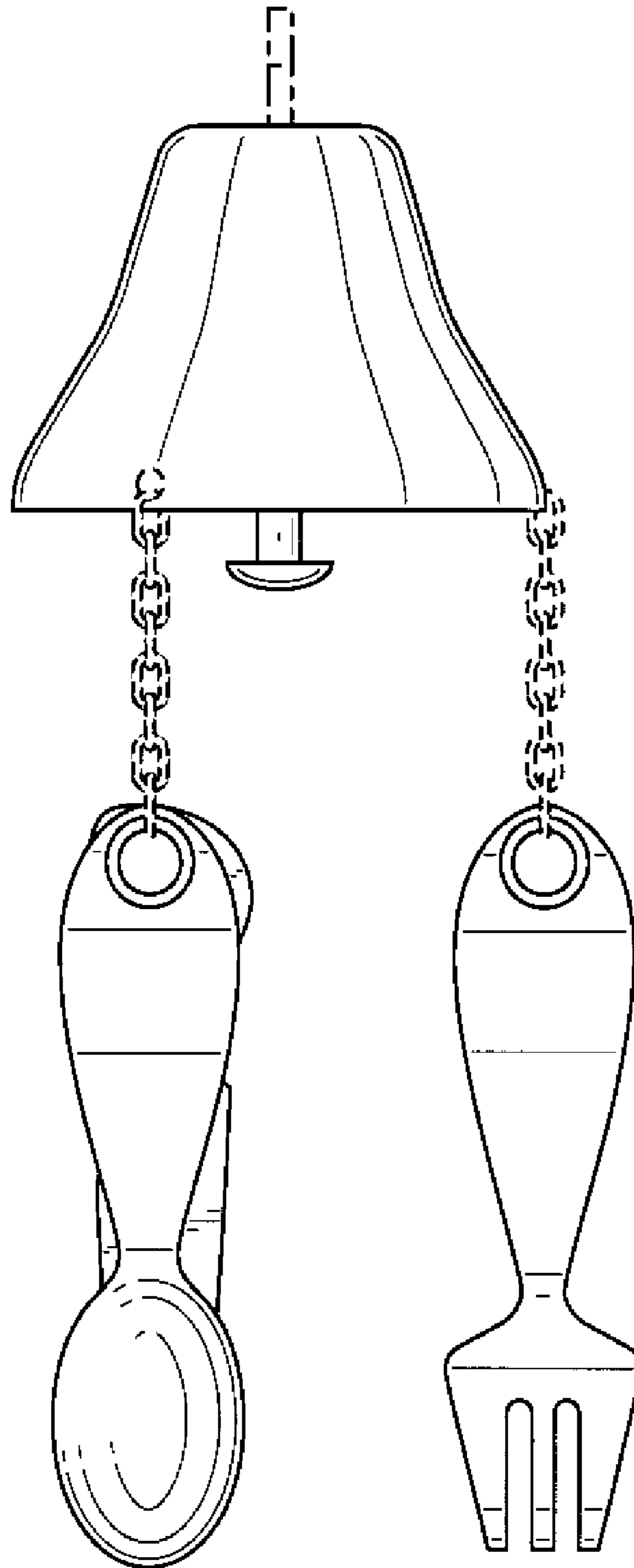

FIG. 4

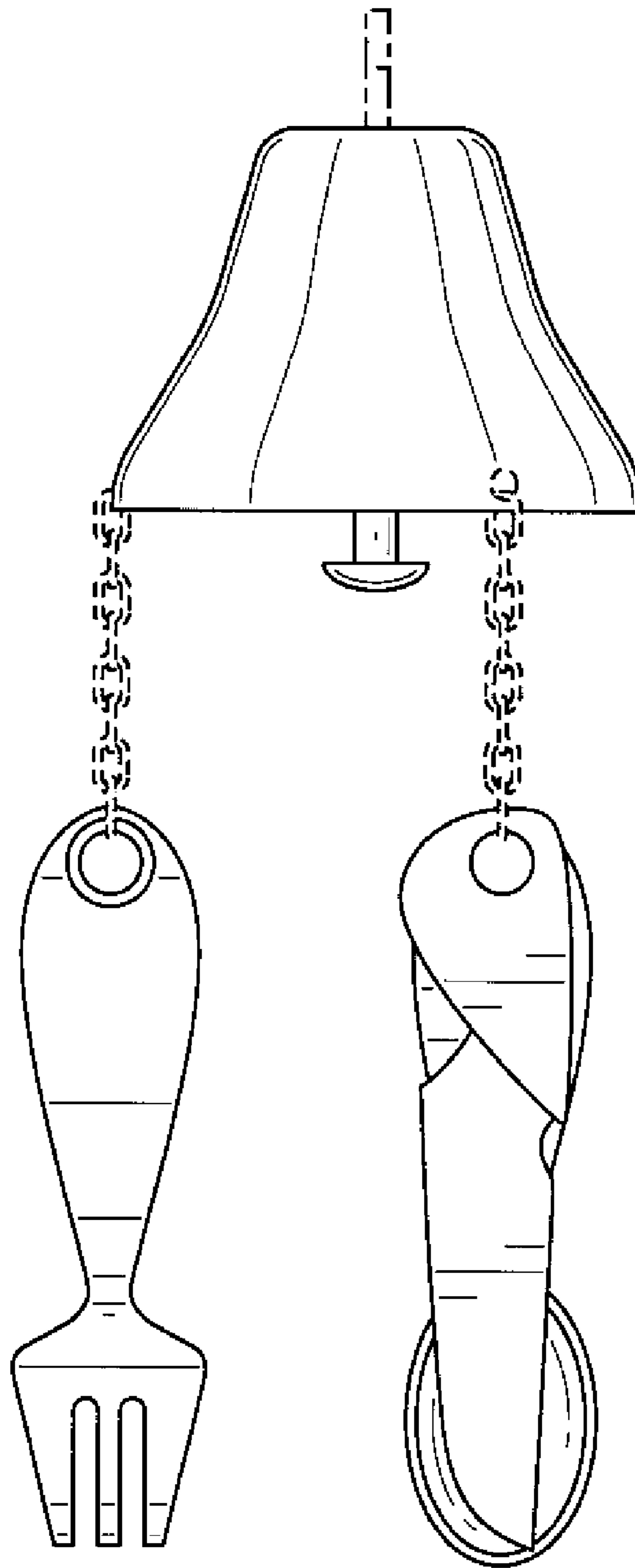

FIG. 5

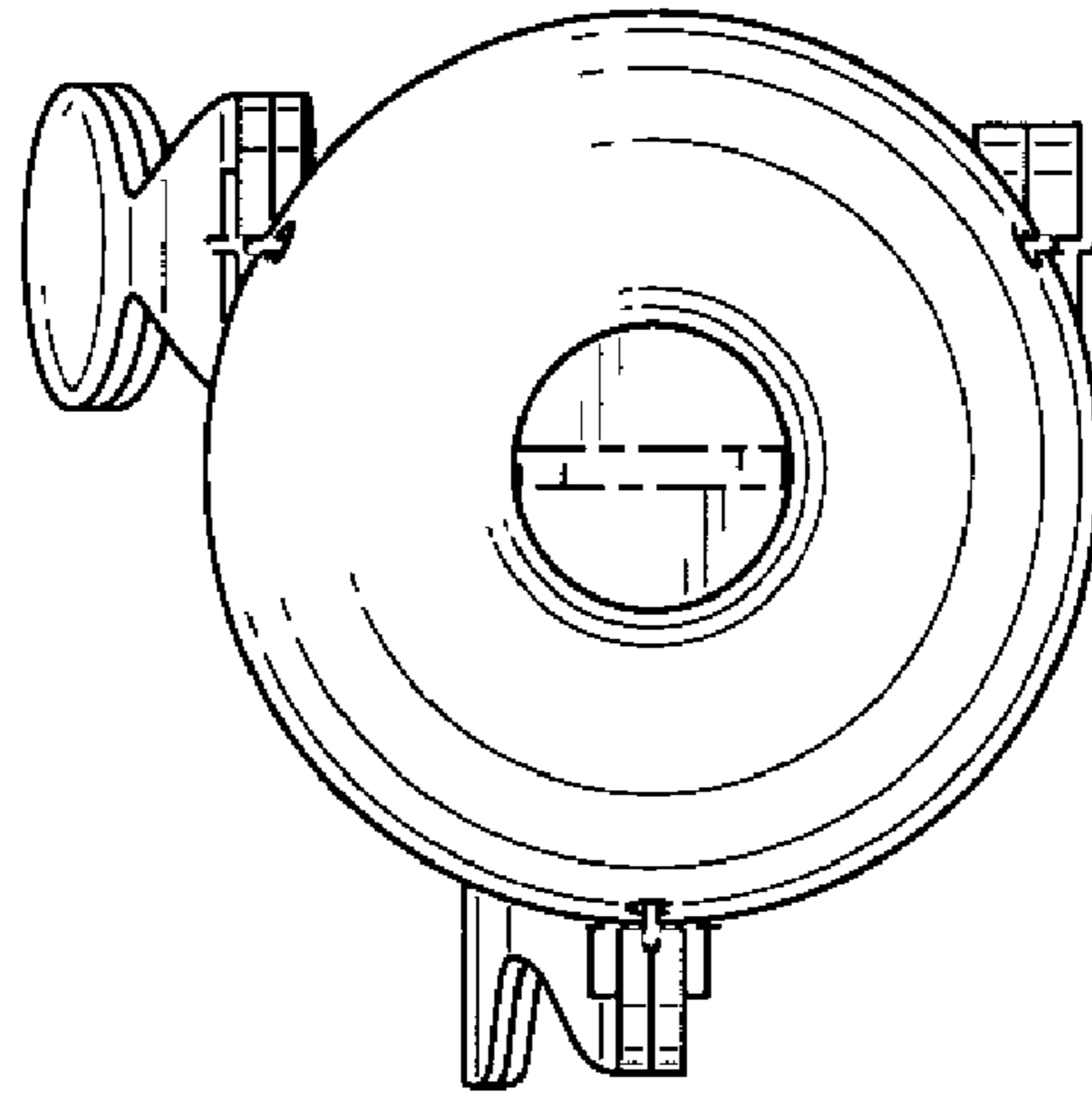

FIG. 6

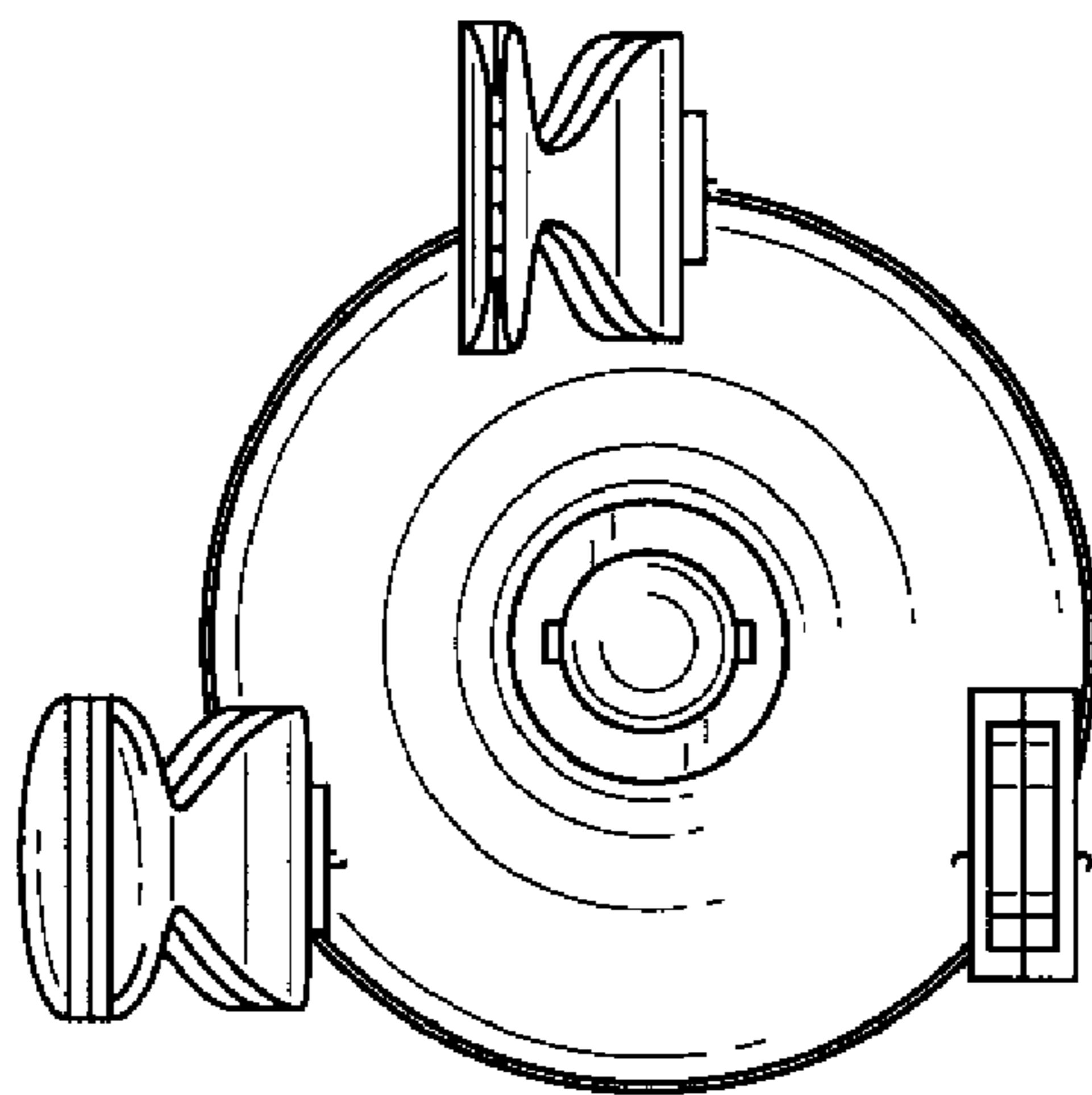

FIG. 7